

# TARIFA 2019

Mediterránea de Válvulas







**TARIFA 2019**

Fecha de 1ª. edición / 1ª. Edition Date / Date 1ª d'edition : **5/2008**  
Fecha de 2ª. edición / 2ª. Edition Date / Date 2ª d'edition : **7/2008**  
Fecha de 3ª. edición / 3ª. Edition Date / Date 3ª d'edition : **6/2009**  
Fecha de 4ª. edición / 4ª. Edition Date / Date 4ª d'edition : **6/2011**  
Fecha de 5ª. edición / 5ª. Edition Date / Date 5ª d'edition : **6/2013**  
Fecha de 6ª. Edición / 6ª. Edition Date / Date 6ª d'edition : **6/2019**



Queda prohibida la reproducción total o parcial de este catálogo sin autorización expresa y por escrito de Mediterránea de Válvulas, S.L. que se reserva el derecho a modificar total o parcialmente el contenido de dicho catálogo.



<b>VÁLVULAS DE LATÓN</b>		<b>10 - 14</b>
Válvulas escuadra	10	
Grifos lavadora	12	
Accesorios	14	
<b>GRIFERÍA TEMPORIZADA</b>		<b>16 - 22</b>
Grifos lavabo	16	
Grifos mural	17	
Grifos fuente	17	
Grifos ducha	19	
Grifos urinario	20	
Fluxómetros y tubos	20	
Rejilla urinario	21	
<b>GRIFOS DE PEDAL</b>		<b>24 - 26</b>
Grifos un pedal	24	
Grifos dos pedales	25	
Caños fijos y giratorios	25	
<b>GRIFERÍA MEDICAL</b>		<b>28 - 30</b>
<b>GRIFERÍA SERIE CATI</b>		<b>32</b>
<b>GRIFERÍA SERIE MINIMALISTA</b>		<b>33</b>
<b>GRIFERÍA SERIE ESFERA</b>		<b>34</b>
<b>GRIFERÍA SERIE NICE</b>		<b>35</b>
<b>GRIFERÍA TERMOSTÁTICA</b>		<b>36</b>
<b>GRIFERÍA HIGIÉNICA WC/BIDET</b>		<b>38</b>
<b>COLUMNAS DE DUCHA</b>		<b>40</b>
<b>GRIFERÍA DE FREGADERO</b>		<b>42 - 46</b>
Monomandos	42	
Baterías	45	
Monoblocs	46	



# ÍNDICE

<b>GRIFERÍA DE UN AGUA</b>	<b>48 - 54</b>
Monomandos	48
Baterías	50
Office	51
<b>RECAMBIOS DE GRIFERÍA</b>	<b>56</b>
<b>ACCESORIOS DE GRIFERÍA</b>	<b>58 - 62</b>
Fijaciones y excéntricas	58
Conexiones flexibles	59
Accesorios grifo extraíble	59
Cartuchos y monturas	60
Atomizadores	61
Adaptadores grifería	62
<b>COMPLEMENTOS DE BAÑO</b>	<b>64 - 72</b>
Mangos de ducha	64
Flexos de ducha	67
Rociadores	68
Brazos y barra de ducha	70
Soportes de ducha	71
Barras de seguridad	72
<b>VÁLVULAS DESAGÜE</b>	<b>74 - 80</b>
Válvulas click-clack	74
Válvulas automáticas y manuales	76
Válvulas bañera y ducha	77
Tapa orificios y tapones	79
Cadena y anillas	80
<b>FILTROS DESAGÜE</b>	<b>82</b>
<b>SIFONES DESAGÜE Y ACCESORIOS</b>	<b>84 - 88</b>
<b>ENCHUFES DE GOMA</b>	<b>90</b>
<b>CABEZALES UNIVERSALES, ACCESORIOS Y REPUESTOS</b>	<b>92 - 96</b>
<b>CONEXIONES FLEXIBLES</b>	<b>98 - 104</b>
Serie A	98
Termo "Serie Súper"	100
Batería de contador	102
Bomba de agua	103
<b>CONEXIONES PARA LAVADORA</b>	<b>106</b>



<b>VÁLVULAS ESFERA EMPOTRAR Y ACCESORIOS</b>	<b>108 - 110</b>
<b>VÁLVULAS DE CONTROL</b>	<b>112 - 116</b>
Soldar	112
Roscar	113
Recambios	114
<b>VÁLVULAS DE ESFERA</b>	<b>118 - 122</b>
Válvulas esfera palanca	118
Válvulas esfera cuadradillo	119
Válvulas esfera palomilla	120
Válvulas esfera mini	121
<b>GRIFOS CURVOS Y ACCESORIOS</b>	<b>124 - 126</b>
Grifo curvo esfera	124
Grifo curvo candado	125
Grifo curvo polipropileno y antihielo	125
Racor, enchufe, unión y boquilla adaptables	126
<b>GRIFOS DECORATIVOS</b>	<b>128 - 130</b>
<b>REDUCTORES DE PRESIÓN Y MANÓMETROS</b>	<b>132 - 134</b>
<b>VÁLVULAS DE RETENCIÓN Y FILTROS</b>	<b>136 - 140</b>
Válvulas de retención H-H	136
Filtros	137
Válvulas de retención M-M	137
Válvulas de retención clapeta	138
Filtro colador tipo "Y"	138
Válvulas de compuerta	138
Válvulas esfera 3 vías	139
Válvulas esfera con retención incorporada	139
Válvulas esfera contador y accesorios	140
<b>RACORES DE CONTADOR Y ACCESORIOS</b>	<b>142</b>
<b>ACCESORIOS TUBO POLIETILENO</b>	<b>144 - 150</b>
Anillo de nylon	144
Anillo de latón	146
Anillo de acero inox. con bridas	148
Recambios	150
<b>GRIFOS FLOTADORES Y BOYAS</b>	<b>152 - 156</b>
Flotadores	152
Boyas	154
Accesorios	156



## **CISTERNA E INODORO**

**158 - 168**

Descargadores y gomas	158
Cisterna y accesorios	161
Tiradores	162
Gomas y juntas	163
Manguitos y tapones	164
Tapas inodoro	166
Accesorios de baño	167

## **ACCESORIOS DE FIJACIÓN**

**170 - 172**

## **RACORERÍA DE LATÓN ROSCAR**

**174 - 188**

Machón doble	174
Marsella hexagonal	176
Reducción hexagonal	177
Reducción lisa	177
Codos	178
Te H-H-H	180
Manguitos	181
Tapón Hembra	182
Tapón Macho	183
Unión 3 piezas	184
Racor depósito uralita	185
Arandela acero y latón	185
Tuercas correderas	186
Alargaderas cilíndricas pulidas y cromadas	186
Codo 3 bocas, cruz 4 bocas, Te 5 vías	187
Bebedero de cerdo	187
Curvas de 90°	187
Collarines	188
Manguitos electrolíticos	188

## **RACORERÍA DE LATÓN SOLDAR**

**190 - 192**

Codos	190
Enlaces y entronques	191
Te H, tapones, curva desviación	192

## **RACORERÍA DE LATÓN PARA RIEGO**

**194 - 198**

## **NIPPELS GALVANIZADOS**

**200 - 202**

## **VÁLVULAS DE FUNDICIÓN**

**204 - 206**

Racores unión	204
Abrazaderas de reparación	205
Conexiones manguera	206
Manguitos antivibratorios	206





<b>CALEFACCIÓN</b>	<b>208 - 218</b>
Purgadores automáticos	208
Purgadores manuales	209
Válvulas de seguridad y retención	209
Válvulas y detentores manuales para radiador	210
Válvulas termostaticables para radiador	212
Colectores	213
Complementos colectores	214
Termostatos y cronotermostatos	215
Tuercas	216
Florones y tapones	217
Soportes radiador y casquillo	218
<b>JUNTAS Y ARANDELAS</b>	<b>220 - 224</b>
Juntas tóricas	220
Juntas planas	221
Arandelas de goma y juntas de fibra	222
Juntas klinger y juntas de teflón	223
<b>MEMBRANAS</b>	<b>226</b>
<b>SOLETAS Y PORTASOLETAS</b>	<b>228</b>
<b>ACCESORIOS DE SELLADO</b>	<b>230 - 231</b>
<b>ACCESORIOS PARA GAS</b>	<b>234 - 240</b>
Reguladores y goma de butano	234
Gas hermeto y soldar	235
Soportes y tapas contador	239
<b>ACCESORIOS DE VENTILACIÓN</b>	<b>242 - 244</b>
Rejillas	242
Difusores	244
<b>SUMIDEROS, CALDERETAS Y BOTE SIFÓNICO</b>	<b>246</b>
<b>ACCESORIOS DE COBRE</b>	<b>248 - 257</b>
Racor recto	248
Racor curvo	250
Manguitos	251
Codos	253
Tapón Hembra	254
Curva de 90°	254
Curva de 45° y curva desviación	255
Te H-H-H	256





## VÁLVULAS DE LATÓN

**Válvulas escuadra**



**10**

**Grifos lavadora**



**12**

**Accesorios**



**14**

## VÁLVULA ESCUADRA



Código	Medida	Caja	Código Barras	€ / Ud.
<b>10001</b>	M 1/2" x M 3/8"	100	8435195800005	<b>2,39</b>
<b>10003</b>	M 1/2" x M 1/2"	100	8435195800029	<b>2,73</b>

- PN 10.
- Latón EN 12165 cromado.
- Temperatura máxima 90°C.
- Mando ABS 1/4 de vuelta con tornillo de sujeción.
- Florón en acero inoxidable.
- Eje de latón.

## VÁLVULA ESCUADRA A-96

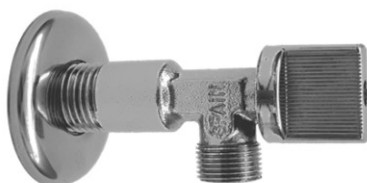

Código	Medida	Caja	Código Barras	€ / Ud.
<b>10002</b>	M 1/2" x M 3/8"	100	8435195800012	<b>2,68</b>
<b>10004</b>	M 1/2" x M 1/2"	100	8435195800036	<b>2,93</b>

- PN 10.
- Latón EN 12165 cromado.
- Temperatura máxima 90°C.
- Mando ABS 1/4 de vuelta con tornillo de sujeción.
- Florón en acero inoxidable.
- Eje de latón.
- **SISTEMA PATENTADO**

## VÁLVULA ESCUADRA A-96 MINI M-H



Código	Medida	Caja	Código Barras	€ / Ud.
<b>10005</b>	H 3/8" x M 3/8"	100	8435195800043	<b>2,96</b>
<b>10006</b>	H 1/2" x M 3/8"	100	8435195800050	<b>2,88</b>

- PN 10.
- Latón EN 12165 cromado.
- Temperatura máxima 90°C.
- Mando ABS 1/4 de vuelta con tornillo de sujeción.
- Eje de latón.
- **SISTEMA PATENTADO**

## VÁLVULA ESCUADRA A-96 MINI M-M



Código	Medida	Caja	Código Barras	€ / Ud.
<b>10008</b>	M 3/8" x M 3/8"	100	8435195800067	<b>2,64</b>

- PN 10.
- Latón EN 12165 cromado.
- Temperatura máxima 90°C.
- Mando ABS 1/4 de vuelta con tornillo de sujeción.
- Eje de latón.
- **SISTEMA PATENTADO**

## VÁLVULAS DE LATÓN



### VÁLVULA ESCUADRA A-96 LARGA



Código	Medida	Caja	Código Barras	€ / Ud.
<b>10010</b>	M 1/2" x M 3/8" 86 mm.	100	8435195800074	<b>3,25</b>
<b>10012</b>	M 1/2" x M 3/8" 96 mm.	100	8435195825442	<b>3,76</b>

- PN 10.
- Latón EN 12165 cromado.
- Temperatura máxima 90°C.
- Mando ABS 1/4 de vuelta con tornillo de sujeción.
- Florón en acero inoxidable.
- Eje de latón.
- **SISTEMA PATENTADO**

### VÁLVULA ESCUADRA CORTA



Código	Medida	Caja	Código Barras	€ / Ud.
<b>10011</b>	M 3/8" x H 3/8" racor loco	100	8435195821406	<b>2,15</b>

- PN 10.
- Latón EN 12165 cromado.
- Temperatura máxima 90°C.
- Mando ABS 1/4 de vuelta con tornillo de sujeción.
- Eje de latón.

### VÁLVULA ESCUADRA CILÍNDRICA



Código	Medida	Caja	Código Barras	€ / Ud.
<b>12101</b>	M 1/2" x M 3/8"	100	8435195821482	<b>5,95</b>
<b>12102</b>	M 1/2" x M 1/2"	50	8435195825497	<b>6,45</b>

- PN 10.
- Latón EN 12165 cromado.
- Temperatura máxima 90°C.
- Florón en acero inoxidable.
- Montura cerámica.

### VÁLVULA ESCUADRA MINIMALISTA



Código	Medida	Caja	Código Barras	€ / Ud.
<b>12105</b>	M 1/2" x M 3/8"	100	8435195821499	<b>6,60</b>
<b>12106</b>	M 1/2" x M 1/2"	50	8435195825503	<b>6,80</b>

- PN 10.
- Latón EN 12165 cromado.
- Temperatura máxima 90°C.
- Florón en acero inoxidable.
- Montura cerámica.

## VÁLVULAS DE LATÓN



### VÁLVULA ESCUADRA CON FILTRO

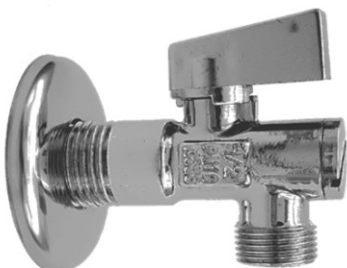

Código	Medida	Caja	Código Barras	€ / Ud.
<b>12001</b>	M 1/2" x M 3/8"	100	8435195820041	<b>3,56</b>
<b>12004</b>	M 1/2" x M 3/4"	50	8435195825480	<b>4,56</b>

- PN 10.
- Latón EN 12165 cromado.
- Temperatura máxima 90°C.
- Florón en acero inoxidable.
- Mando ABS 1/4 de vuelta con tornillo de sujección.
- Eje de latón.

### GRIFO LAVADORA

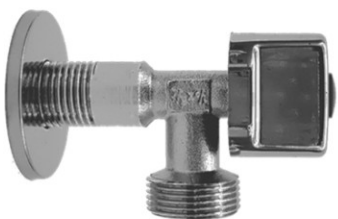

Código	Medida	Caja	Código Barras	€ / Ud.
<b>11002</b>	M 1/2" x M 3/4"	50	8435195800142	<b>3,89</b>

- PN 10.
- Latón EN 12165 cromado.
- Temperatura máxima 90°C.
- Mando ABS 1/4 de vuelta con tornillo de sujección.
- Florón en acero inoxidable.
- Eje de latón.
- **SISTEMA PATENTADO**

### GRIFO LAVADORA



Código	Medida	Caja	Código Barras	€ / Ud.
<b>11004</b>	M 1/2" x M 3/4"	50	8435195825459	<b>3,39</b>

- PN 10.
- Latón EN 12165 cromado.
- Temperatura máxima 90°C.
- Mando ABS SAFOR 1/4 de vuelta con tornillo de sujección.
- Florón en acero inoxidable.
- Eje de latón.

### GRIFO LAVADORA LARGO

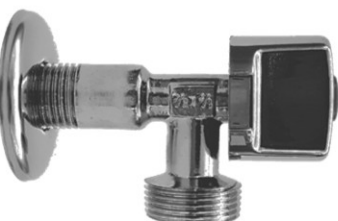

Código	Medida	Caja	Código Barras	€ / Ud.
<b>11006</b>	M 1/2" x M 3/4"	50	8435195820027	<b>3,86</b>

- PN 10.
- Latón EN 12165 cromado.
- Temperatura máxima 90°C.
- Mando ABS 1/4 de vuelta con tornillo de sujección.
- Florón en acero inoxidable.
- Eje de latón.

## GRIFO LAVADORA CORTO



Código	Medida	Caja	Código Barras	€ / Ud.
<b>11510</b>	M 1/2" x M 3/4"	100	8435195820034	<b>2,68</b>

- PN 10.
- Latón EN 12165 cromado.
- Temperatura máxima 90°C.
- Mando ABS 1/4 de vuelta con tornillo de sujeción.
- Florón en acero inoxidable.
- Eje de latón.

## GRIFO LAVADORA CON VÁLVULA DE REGULACIÓN



Código	Medida	Caja	Código Barras	€ / Ud.
<b>11508</b>	M 1/2" x M 3/4" x M 3/8"	50	8435195834048	<b>9,05</b>
<b>11509</b>	M 1/2" x M 1/2" x M 3/8"	50	8435195834055	<b>8,90</b>

- PN 10.
- Latón EN 12165 cromado.
- Temperatura máxima 90°C.
- Mandos ABS 1/4 de vuelta con tornillos de sujeción.
- Florón en acero inoxidable.
- Eje de latón.

## VÁLVULA MIXTA LAVADORA - LAVABO



Código	Medida	Caja	Código Barras	€ / Ud.
<b>25517</b>	M 1/2" x M 3/8" x M 3/4"	50	8435195801927	<b>9,59</b>

- PN 10.
- Latón EN 12165 cromado.
- Temperatura máxima 90°C.
- Mando ABS.
- Florón en acero inoxidable.

# VÁLVULAS DE LATÓN



## CODO LATÓN PULIDO Y CROMADO



Código	Medida	Caja	Código Barras	€ / Ud.
<b>12130</b>	M 1/2" x M 3/8"	50	8435195821505	<b>2,90</b>
<b>12131</b>	M 1/2" x M 1/2"	50	8435195821512	<b>3,79</b>

- PN 10.
- Latón EN 12165 cromado y pulido.
- Temperatura máxima 90°C.
- Florón en acero inoxidable.

## CODO MONOBLOC CROMADO



Código	Medida	Caja	Código Barras	€ / Ud.
<b>64501</b>	M 1/2" x M 3/8"	50	8435195810127	<b>1,58</b>

- PN 10.
- Latón EN 12165 cromado.
- Temperatura máxima 90°C.

## FLORÓN ACERO INOXIDABLE



Código	Medida	Caja	Código Barras	€ / Ud.
<b>63501</b>	3/8" Sin garras	100	8435195809671	<b>0,16</b>
<b>63502</b>	1/2" x 55 Sin garras	100	8435195809688	<b>0,15</b>
<b>63504</b>	1/2" x 55 Con garras	100	8435195809701	<b>0,15</b>
<b>63506</b>	1/2" x 65 Sin garras	100	8435195825510	<b>0,34</b>
<b>63509</b>	1/2" x 65 Con garras	100	8435195825527	<b>0,29</b>
<b>63508</b>	3/4" x 65 Sin garras	100	8435195808308	<b>0,32</b>

## TUERCA ENLACE



	Código	Medida	Caja	Código Barras	€ / Ud.
Su color	<b>71001</b>	3/8" x 10 Ø	100	8435195811629	<b>0,47</b>
	<b>71002</b>	1/2" x 10 Ø	100	8435195811636	<b>0,59</b>
	<b>71003</b>	1/2" x 12 Ø	100	8435195811643	<b>0,64</b>
Cromo	<b>71004</b>	3/8" x 10 Ø	100	8435195811650	<b>0,56</b>
	<b>71005</b>	1/2" x 10 Ø	100	8435195811667	<b>0,65</b>
	<b>71006</b>	1/2" x 12 Ø	100	8435195811674	<b>0,70</b>

## BICONO DE CAUCHO









Código	Medida	Caja	Código Barras	€ / Ud.
<b>74002</b>	3/8" x 10 Ø	100	8435195812206	<b>0,087</b>
<b>74003</b>	1/2" x 12 Ø	100	8435195812213	<b>0,087</b>
<b>74004</b>	1/2" x 10 Ø	100	8435195812220	<b>0,087</b>





## GRIFERÍA TEMPORIZADA

<b>Grifos lavabo</b>		<b>16</b>
<b>Grifos mural</b>		<b>17</b>
<b>Grifos fuente</b>		<b>17</b>
<b>Grifos ducha</b>		<b>19</b>
<b>Grifos urinario</b>		<b>20</b>
<b>Fluxómetros y tubos</b>		<b>20</b>
<b>Rejilla urinario</b>		<b>21</b>



## GRIFERÍA TEMPORIZADA

### GRIFO LAVABO



Código	Medida	Caja	Código Barras	€ / Ud.
<b>1001</b>	1/2"	2	8435195817201	<b>41,95</b>

- Tiempo de apertura estándar de 8 a 12 segundos.
- Cuerpo fabricado en latón según EN1982 y cromado.
- Atomizador de latón.

	Código	Descripción	Código Barras	€ / Ud.
<b>Recambio</b>	<b>1012</b>	Montura + Pulsador	8435195817249	<b>16,40</b>

### GRIFO LAVABO MINIMALISTA



Código	Medida	Caja	Código Barras	€ / Ud.
<b>1002</b>	1/2"	2	8435195821529	<b>41,95</b>

- Tiempo de apertura estándar de 8 a 12 segundos.
- Cuerpo fabricado en latón según EN1982 y cromado.
- Atomizador de latón.

### GRIFO LAVABO REPISA



Código	Medida	Caja	Código Barras	€ / Ud.
<b>1005</b>	1/2"	2	8435195817225	<b>72,56</b>

- Tiempo de apertura estándar de 8 a 12 segundos.
- Cuerpo fabricado en latón según EN1982 y cromado.
- Atomizador de latón.

	Código	Descripción	Código Barras	€ / Ud.
<b>Recambio</b>	<b>1017</b>	Montura + Pulsador	8435195834062	<b>33,50</b>

### GRIFO LAVABO MEZCLADOR



Código	Medida	Caja	Código Barras	€ / Ud.
<b>1009</b>	1/2"	2	8435195828283	<b>105,70</b>

- Tiempo de apertura estándar de 8 a 12 segundos.
- Dotado de válvula antirretorno
- Cuerpo fabricado en latón según EN1982 y cromado.
- Atomizador de latón.

	Código	Descripción	Código Barras	€ / Ud.
<b>Recambio</b>	<b>1017</b>	Montura + Pulsador	8435195834062	<b>33,50</b>

## GRIFERÍA TEMPORIZADA



### GRIFO MURAL



Código	Medida	Caja	Código Barras	€ / Ud.
<b>1003</b>	1/2"	2	8435195817218	<b>55,94</b>

- Tiempo de apertura estándar de 8 a 12 segundos.
- Cuerpo fabricado en latón según EN 1982.
- Cromado.

	Código	Descripción	Código Barras	€ / Ud.
<b>Recambio</b>	<b>1017</b>	Montura + Pulsador	8435195834062	<b>33,50</b>

### GRIFO MURAL



Código	Medida	Caja	Código Barras	€ / Ud.
<b>1031</b>	1/2"	2	8435195817294	<b>25,55</b>

- Tiempo de apertura estándar de 8 a 12 segundos.
- Cuerpo fabricado en latón según EN 1982.
- Cromado.

	Código	Descripción	Código Barras	€ / Ud.
<b>Recambio</b>	<b>1012</b>	Montura + Pulsador	8435195817249	<b>16,40</b>

### GRIFO FUENTE VERTICAL



Código	Medida	Caja	Código Barras	€ / Ud.
<b>1033</b>	3/8"	2	8435195817300	<b>52,60</b>

- Tiempo de apertura estándar de 8 a 12 segundos.
- Cuerpo fabricado en latón según EN 1982.
- Cromado.

	Código	Descripción	Código Barras	€ / Ud.
<b>Recambio</b>	<b>1014</b>	Montura + Pulsador	8435195817263	<b>17,84</b>

### GRIFO FUENTE CAÑO ALTO



Código	Medida	Caja	Código Barras	€ / Ud.
<b>1034</b>	3/8"	2	8435195817317	<b>55,07</b>

- Tiempo de apertura estándar de 8 a 12 segundos.
- Cuerpo fabricado en latón según EN 1982.
- Cromado.

	Código	Descripción	Código Barras	€ / Ud.
<b>Recambio</b>	<b>1036</b>	Montura + Pulsador	8435195834079	<b>27,17</b>

## GRIFERÍA TEMPORIZADA



### GRIFO FUENTE PÚBLICA S/COLOR



Código	Medida	Caja	Código Barras	€ / Ud.
<b>1035</b>	1/2"	1	8435195828290	<b>36,13</b>
<b>1037</b>	3/4"	1	8435195828306	<b>37,34</b>
<b>1038</b>	1"	1	8435195828313	<b>59,26</b>

- Cuerpo fabricado en latón según EN 1982.
- Su color.

### GRIFO FUENTE PÚBLICA CROMO



Código	Medida	Caja	Código Barras	€ / Ud.
<b>1047</b>	1/2"	1	8435195828320	<b>60,48</b>
<b>1048</b>	3/4"	1	8435195828337	<b>66,08</b>
<b>1049</b>	1"	1	8435195828344	<b>82,48</b>

- Cuerpo fabricado en latón según EN 1982.
- Cromado.

### GRIFO FUENTE PÚBLICA PULSADOR VERTICAL S/COLOR



Código	Medida	Caja	Código Barras	€ / Ud.
<b>1125</b>	1/2"	1	8435195834086	<b>45,85</b>

- Cuerpo fabricado en latón según EN 1982.
- Su color.

### GRIFO FUENTE PÚBLICA PULSADOR FRONTAL S/COLOR



Código	Medida	Caja	Código Barras	€ / Ud.
<b>1126</b>	1/2"	1	8435195834093	<b>43,78</b>

- Cuerpo fabricado en latón según EN 1982.
- Su color.

## GRIFERÍA TEMPORIZADA



### GRIFO DUCHA / URINARIO EMPOTRAR



Código	Medida	Caja	Código Barras	€ / Ud.
<b>1020</b>	1/2"	2	8435195817287	<b>57,96</b>

- Tiempo de apertura estandar ducha: 15/25"
- Tiempo de apertura estandar urinario: 4/6"
- Cuerpo fabricado en latón según EN 1982.

### GRIFO DUCHA / URINARIO VISTO



Código	Medida	Caja	Código Barras	€ / Ud.
<b>1021</b>	1/2"	2	8435195821529	<b>45,42</b>

- Tiempo de apertura pre regulada.
- Tiempo de apertura estandar urinario: 4/6"
- Cuerpo fabricado en latón según EN 1982.
- Cromado.

### GRIFO DUCHA MEZCLADOR EMPOTRAR



Código	Medida	Caja	Código Barras	€ / Ud.
<b>1022</b>	1/2"	2	8435195828139	<b>134,36</b>

- Tiempo de apertura estandar: 15/25"
- Dotada de válvula antirretorno.
- Cuerpo fabricado en latón según EN 1982.

### GRIFO DUCHA MEZCLADOR VISTO



Código	Medida	Caja	Código Barras	€ / Ud.
<b>1023</b>	1/2"	2	8435195828146	<b>142,09</b>

- Tiempo de apertura estandar: 15/25"
- Dotada de válvula antirretorno.
- Cuerpo fabricado en latón según EN 1982.
- Cromado.

### GRIFO PREMEZCLADOR



Código	Medida	Caja	Código Barras	€ / Ud.
<b>1057</b>	1/2"	2	8435195817423	<b>52,41</b>

- Tiempo de apertura estándar: 12/16"
- Dotada de válvula antirretorno.
- Cuerpo fabricado en latón según EN 1982.

## GRIFERÍA TEMPORIZADA



### GRIFO URINARIO



Código	Medida	Caja	Código Barras	€ / Ud.
<b>1010</b>	1/2"	2	8435195817232	<b>38,75</b>

- Tiempo de apertura estándar de 8 a 12 segundos.
- Cuerpo fabricado en latón según EN 1982.
- Con accesorio para urinario recto.
- Cromado.

	Código	Descripción	Código Barras	€ / Ud.
<b>Recambio</b>	<b>1013</b>	Montura + Pulsador	8435195817256	<b>17,15</b>
	<b>1011</b>	Tubo recto + florón	8435195815528	<b>6,90</b>
	<b>1024</b>	Tubo curvo 15,5 cm + florón + tuerca	8435195834109	<b>11,97</b>

### GRIFO URINARIO MINIMALISTA



Código	Medida	Caja	Código Barras	€ / Ud.
<b>1050</b>	1/2" Cuadrado	2	8435195821536	<b>37,76</b>
<b>1016</b>	1/2" Cilíndrico	2	8435195825572	<b>49,80</b>

- Tiempo de apertura estándar de 8 a 12 segundos.
- Cuerpo fabricado en latón según EN 1982.
- Tubo de salida ajustable.
- Cromado.

### FLUXÓMETRO EMPOTRAR TEMPORIZADO



Código	Medida	Caja	Código Barras	€ / Ud.
<b>1064</b>	3/4"	2	8435195817430	<b>68,20</b>

- Tiempo de apertura estándar de 5 a 8 segundos.
- Cuerpo fabricado en latón según EN 1982.
- Cromado.

	Código	Descripción	Código Barras	€ / Ud.
<b>Recambio</b>	<b>1004</b>	Montura + Pulsador	8435195833997	<b>31,14</b>

### FLUXÓMETRO VISTO TEMPORIZADO



Código	Medida	Caja	Código Barras	€ / Ud.
<b>1065</b>	3/4"	2	8435195817447	<b>67,11</b>
<b>1075</b>	1"	2	8435195817454	<b>65,98</b>

- Tiempo de apertura estándar de 5 a 8 segundos.
- Cuerpo fabricado en latón según EN 1982.
- Cromado.

## TUBO CROMADO EXTENSIBLE

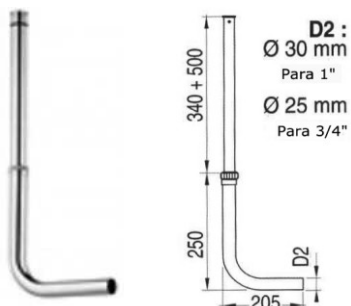

Código	Medida	Caja	Código Barras	€ / Ud.
<b>1066</b>	Ø 25 x 3/4"	2	8435195817461	<b>35,85</b>
<b>1067</b>	Ø 32 x 1"	2	8435195817478	<b>35,85</b>

- Accesorio para fluxómetro empotrado y visto.
- Cuerpo fabricado en latón según EN 12165.
- Cromado.

## FILTRO REJILLA URINARIO



Código	Medida	Caja	Código Barras	€ / Ud.
<b>85121</b>	Única	10	8435195823684	<b>1,05</b>







## GRIFOS DE PEDAL

**Grifos un pedal**



**24**

**Grifos dos pedales**



**25**

**Caños fijos y giratorios**



**25**



## GRIFOS DE PEDAL

### GRIFO PEDAL UN AGUA



Código	Medida	Caja	Código Barras	€ / Ud.
<b>1055</b>	1/2"	2	8435195817416	<b>71,98</b>

- Cuerpo latón cromado.
- Regulación de caudal incorporado.
- Agua fría con caudal constante.
- Sujección al suelo y pared.

### GRIFO PEDAL UN AGUA TEMPORIZADO "LUX"



Código	Medida	Caja	Código Barras	€ / Ud.
<b>1082</b>	1/2"	2	8435195828153	<b>98,71</b>

- Cuerpo latón cromado.
- Regulación de caudal incorporado.
- Agua fría con caudal constante.
- Sujección al suelo y pared.
- Modelo LUX.

### GRIFO PEDAL MEZCLADOR



Código	Medida	Caja	Código Barras	€ / Ud.
<b>1053</b>	1/2"	2	8435195817386	<b>81,98</b>

- Cuerpo latón cromado.
- Regulación de caudal incorporado.
- Agua fría y progresivamente agua mezclada.
- Sujección al suelo y pared.



## GRIFOS DE PEDAL Y ACCESORIOS

### GRIFO DOS PEDALES



Código	Medida	Caja	Código Barras	€ / Ud.
<b>1056</b>	1/2"	2	8435195817409	<b>169,25</b>

- Cuerpo latón cromado.
- Regulación de caudal incorporado.
- Agua fría y caliente. Pulsando ambos pedales: agua mezclada.
- Sujeción al suelo.

### GRIFO DOS PEDALES



Código	Medida	Caja	Código Barras	€ / Ud.
<b>1083</b>	1/2"	2	8435195828160	<b>193,28</b>

- Cuerpo latón cromado.
- Regulación de caudal incorporado.
- Agua fría y caliente. Pulsando ambos pedales: agua mezclada.
- Sujeción al suelo y pared.
- Modelo LUX.

### CAÑO FIJO



Código	Medida	Caja	Código Barras	€ / Ud.
<b>1040</b>	1/2"	2	8435195817324	<b>35,70</b>

- Caño fundido a pared. • Con atomizador.



Código	Medida	Caja	Código Barras	€ / Ud.
<b>1041</b>	1/2"	2	8435195817331	<b>52,91</b>

- Caño fundido a encimera. • Con atomizador.



Código	Medida	Caja	Código Barras	€ / Ud.
<b>1054</b>	1/2"	2	8435195821550	<b>38,25</b>

- Caño fundido a encimera. • Con atomizador.

### CAÑO GIRATORIO



Código	Medida	Caja	Código Barras	€ / Ud.
<b>1042</b>	1/2"	2	8435195817348	<b>69,76</b>

- Caño fundido a encimera. • Con atomizador.



Código	Medida	Caja	Código Barras	€ / Ud.
<b>1043</b>	1/2"	2	8435195817355	<b>35,90</b>

- Caño tubo a encimera 200 mm. • Con atomizador.



Código	Medida	Caja	Código Barras	€ / Ud.
<b>1044</b>	1/2"	2	8435195827910	<b>41,58</b>

- Caño a pared bajo. • Con atomizador.



Código	Medida	Caja	Código Barras	€ / Ud.
<b>1045</b>	1/2"	2	8435195827996	<b>41,58</b>

- Caño a pared alto. • Con atomizador





## GRIFERÍA MEDICAL

**Grifos mural**



**28**

**Grifos lavabo**



**28**

**Grifos fregadero**



**29**

## GRIFERÍA MEDICAL



### GRIFO MURAL MEDICAL CAÑO BAJO



Código	Medida	Caja	Código Barras	€ / Ud.
<b>25551</b>	1/2"	1	8435195825268	<b>92,29</b>

- Caño bajo giratorio tubo de latón.
- Cuerpo fabricado en latón según EN 1982.
- Cromado.
- Entrada M 1/2.

### GRIFO MURAL MEDICAL 1/2"



Código	Medida	Caja	Código Barras	€ / Ud.
<b>25555</b>	1/2"	1	8435195825305	<b>33,63</b>

- Cuerpo fabricado en latón según EN 1982.
- Cromado.
- Entrada M 1/2.

### GRIFO MURAL MEDICAL ITÁLICO



	Código	Medida	Caja	Código Barras	€ / Ud.
<b>Corto</b>	<b>25505</b>	1/2"	1	8435195801873	<b>16,69</b>
<b>Largo</b>	<b>25506</b>	1/2"	1	8435195801880	<b>17,03</b>

- Cuerpo fabricado en latón según EN 1982.
- Cromado.
- Entrada M 1/2.

	Código	Descripción	Código Barras	€ / Ud.
<b>Recambio</b>	<b>19054</b>	Palanca medical	8435195834925	<b>9,47</b>

### GRIFO LAVABO MEDICAL



Código	Medida	Caja	Código Barras	€ / Ud.
<b>25556</b>	1/2"	1	8435195825312	<b>35,49</b>

- Cuerpo fabricado en latón según EN 1982.
- Cromado.
- Atomizador de latón

## MONOMANDO FREGADERO MEDICAL



- Caño alto orientable tubo de latón.
- Cuerpo latón pulido y cromado.
- Cartucho cerámico de 40 mm.
- Conexiones Aenor H3/8\*35 cm.
- Atomizador de latón M 24/100.

Código	Medida	Caja	Código Barras	€ / Ud.
<b>25552</b>	-	1	8435195825275	<b>49,76</b>

	Código	Descripción	Código Barras	€ / Ud.
<b>Recambio</b>	<b>1110</b>	Cartucho 40 mm.	8435195821116	<b>3,96</b>

## MONOMANDO FREGADERO MURAL MEDICAL



- Caño bajo orientable tubo de latón.
- Cuerpo latón pulido y cromado.
- Cartucho cerámico de 40 mm.
- Excéntricas de latón niquelado.
- Atomizador de latón M 24/100.

Código	Medida	Caja	Código Barras	€ / Ud.
<b>25553</b>	-	1	8435195825282	<b>89,20</b>

	Código	Descripción	Código Barras	€ / Ud.
<b>Recambio</b>	<b>1110</b>	Cartucho 40 mm.	8435195821116	<b>3,96</b>

## MONOMANDO LAVABO MEDICAL



- Cuerpo fabricado en latón según EN 1982.
- Cromado.
- Cartucho cerámico de 40 mm.
- Conexiones Aenor 10/100\*3/8\*35 cm.
- Atomizador de latón

Código	Medida	Caja	Código Barras	€ / Ud.
<b>25557</b>	-	1	8435195825329	<b>66,78</b>

	Código	Descripción	Código Barras	€ / Ud.
<b>Recambio</b>	<b>1110</b>	Cartucho 40 mm.	8435195821116	<b>3,96</b>

## PALANCA GERONTOLÓGICA - MEDICAL CROMO



Código	Medida	Caja	Código Barras	€ / Ud.
<b>1105</b>	-	1	8435195834512	<b>37,46</b>







## GRIFERÍA SERIE

<b>Grifería serie CATI</b>		<b>32</b>
<b>Grifería serie MINIMALISTA</b>		<b>33</b>
<b>Grifería serie ESFERA</b>		<b>34</b>
<b>Grifería serie NICE</b>		<b>35</b>
<b>Grifería TERMOSTÁTICA</b>		<b>36</b>

## GRIFERÍA SERIE CATI



### MONOMANDO LAVABO CATI



Código	Medida	Caja	Código Barras	€ / Ud.
<b>1170</b>	-	1	8435195815535	<b>34,45</b>

- Cuerpo latón pulido y cromado.
- Cartucho cerámico de 40 mm.
- Conexiones Aenor 10/100\*3/8\*35 cm.
- Atomizador de latón M 24/100.

Recambio	Código	Descripción	Código Barras	€ / Ud.
	<b>1110</b>	Cartucho 40 mm.	8435195821116	<b>3,96</b>

### MONOMANDO BIDET CATI

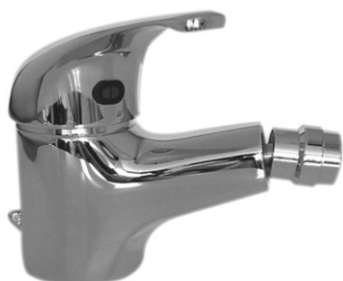

Código	Medida	Caja	Código Barras	€ / Ud.
<b>1171</b>	-	1	8435195815542	<b>34,45</b>

- Cuerpo latón pulido y cromado.
- Cartucho cerámico de 40 mm.
- Conexiones Aenor 10/100\*3/8\*35 cm.
- Atomizador de latón M 24/100.

Recambio	Código	Descripción	Código Barras	€ / Ud.
	<b>1110</b>	Cartucho 40 mm.	8435195821116	<b>3,96</b>

### MONOMANDO DUCHA CATI



Código	Medida	Caja	Código Barras	€ / Ud.
<b>1172</b>	-	1	8435195815559	<b>40,62</b>

- Cuerpo latón pulido y cromado.
- Cartucho cerámico de 40 mm.
- Excéntricas de latón niquelado.
- Incluye mango de ducha, soporte y flexo.

Recambio	Código	Descripción	Código Barras	€ / Ud.
	<b>1110</b>	Cartucho 40 mm.	8435195821116	<b>3,96</b>

### MONOMANDO BAÑO CATI



Código	Medida	Caja	Código Barras	€ / Ud.
<b>1173</b>	-	1	8435195815566	<b>48,88</b>

- Cuerpo latón pulido y cromado.
- Cartucho cerámico de 40 mm.
- Excéntricas de latón niquelado.
- Incluye mango de ducha, soporte y flexo.
- Atomizador de latón M 24/100.

Recambio	Código	Descripción	Código Barras	€ / Ud.
	<b>1110</b>	Cartucho 40 mm.	8435195821116	<b>3,96</b>

## GRIFERÍA SERIE MINIMALISTA



### MONOMANDO LAVABO MINIMALISTA



Código	Medida	Caja	Código Barras	€ / Ud.
<b>1180</b>	-	1	8435195815580	<b>39,90</b>

- Cuerpo latón pulido y cromado.
- Cartucho cerámico de 40 mm.
- Conexiones Aenor 10/100\*3/8\*35 cm.
- Atomizador de latón M 24/100.

	Código	Descripción	Código Barras	€ / Ud.
<b>Recambio</b>	<b>1110</b>	Cartucho 40 mm.	8435195821116	<b>3,96</b>

### MONOMANDO BIDET MINIMALISTA



Código	Medida	Caja	Código Barras	€ / Ud.
<b>1181</b>	-	1	8435195815597	<b>37,80</b>

- Cuerpo latón pulido y cromado.
- Cartucho cerámico de 40 mm.
- Conexiones Aenor 10/100\*3/8\*35 cm.
- Atomizador de latón M 24/100.

	Código	Descripción	Código Barras	€ / Ud.
<b>Recambio</b>	<b>1110</b>	Cartucho 40 mm.	8435195821116	<b>3,96</b>

### MONOMANDO DUCHA MINIMALISTA



Código	Medida	Caja	Código Barras	€ / Ud.
<b>1183</b>	-	1	8435195815610	<b>77,28</b>

- Cuerpo latón pulido y cromado.
- Cartucho cerámico de 40 mm.
- Excéntricas de latón niquelado.
- Incluye mango de ducha, soporte y flexo.

	Código	Descripción	Código Barras	€ / Ud.
<b>Recambio</b>	<b>1110</b>	Cartucho 40 mm.	8435195821116	<b>3,96</b>

### MONOMANDO BAÑO MINIMALISTA



Código	Medida	Caja	Código Barras	€ / Ud.
<b>1182</b>	-	1	8435195815603	<b>85,67</b>

- Cuerpo latón pulido y cromado.
- Cartucho cerámico de 40 mm.
- Excéntricas de latón niquelado.
- Incluye mango de ducha, soporte y flexo.
- Atomizador de latón M 24/100.

	Código	Descripción	Código Barras	€ / Ud.
<b>Recambio</b>	<b>1110</b>	Cartucho 40 mm.	8435195821116	<b>3,96</b>

## GRIFERÍA SERIE ESFERA



### MONOBLOC LAVABO ESFERA



Código	Medida	Caja	Código Barras	€ / Ud.
<b>1084</b>	-	1	8435195817553	<b>59,40</b>

- Cuerpo latón pulido y cromado.
- Monturas cerámica de media vuelta.
- Conexiones Aenor 10/100\*3/8\*35 cm.
- Atomizador de latón M 24/100.

	Código	Descripción	Código Barras	€ / Ud.
<b>Recambio</b>	<b>1080</b>	Montura cerámica 1/2"	8435195834116	<b>2,70</b>

### MONOBLOC BIDET ESFERA



Código	Medida	Caja	Código Barras	€ / Ud.
<b>1085</b>	-	1	8435195817560	<b>49,06</b>

- Cuerpo latón pulido y cromado.
- Monturas cerámica de media vuelta.
- Conexiones Aenor 10/100\*3/8\*35 cm.
- Atomizador de latón M 24/100.

	Código	Descripción	Código Barras	€ / Ud.
<b>Recambio</b>	<b>1080</b>	Montura cerámica 1/2"	8435195834116	<b>2,70</b>

### MONOBLOC DUCHA ESFERA



Código	Medida	Caja	Código Barras	€ / Ud.
<b>1087</b>	-	1	8435195817584	<b>59,40</b>

- Cuerpo latón pulido y cromado.
- Monturas cerámica de media vuelta.
- Excéntricas de latón niquelado.
- Incluye mango de ducha de latón cromado, soporte y flexo.

	Código	Descripción	Código Barras	€ / Ud.
<b>Recambio</b>	<b>1080</b>	Montura cerámica 1/2"	8435195834116	<b>2,70</b>

### MONOBLOC BAÑO ESFERA



Código	Medida	Caja	Código Barras	€ / Ud.
<b>1086</b>	-	1	8435195817577	<b>68,10</b>

- Cuerpo latón pulido y cromado.
- Monturas cerámica de media vuelta.
- Excéntricas de latón niquelado.
- Incluye mango de ducha de latón cromado, soporte y flexo.

	Código	Descripción	Código Barras	€ / Ud.
<b>Recambio</b>	<b>1080</b>	Montura cerámica 1/2"	8435195834116	<b>2,70</b>

## MONOMANDO LAVABO NICE



Código	Medida	Caja	Código Barras	€ / Ud.
<b>1201</b>	-	1	8435195847758	<b>38,00</b>

- Cuerpo latón pulido y cromado.
- Cartucho cerámico de 40 mm.
- Conexiones Aenor 10/100\*3/8\*35 cm.
- Atomizador antivandálico de latón M 24/100.

## MONOMANDO LAVABO EMPOTRAR NICE



Código	Medida	Caja	Código Barras	€ / Ud.
<b>1202</b>	-	1	8435195847765	<b>99,00</b>

- Cuerpo latón pulido y cromado.
- Cartucho cerámico de 40 mm.
- Atomizador antivandálico de latón M 24/100.

## MONOMANDO BIDET NICE



Código	Medida	Caja	Código Barras	€ / Ud.
<b>1203</b>	-	1	8435195847772	<b>36,50</b>

- Cuerpo latón pulido y cromado.
- Cartucho cerámico de 40 mm.
- Conexiones Aenor 10/100\*3/8\*35 cm.
- Atomizador con rótula de latón M 24/100.

## MONOMANDO DUCHA EMPOTRAR 1 VÍA NICE



Código	Medida	Caja	Código Barras	€ / Ud.
<b>1204</b>	H 1/2"	1	8435195847789	<b>50,00</b>

- Mezclador agua fría/caliente.
- Cartucho cerámico de 40 mm.

## MONOMANDO DUCHA EMPOTRAR 2 VÍAS NICE



Código	Medida	Caja	Código Barras	€ / Ud.
<b>1205</b>	H 1/2"	1	8435195847796	<b>76,50</b>

- Mezclador agua fría/caliente.
- Con distribuidor: tres posiciones.

# GRIFERÍA TERMOSTÁTICA



## TERMOSTÁTICA DUCHA



Código	Medida	Caja	Código Barras	€ / Ud.
<b>1187</b>	-	1	8435195817607	<b>99,27</b>

- Cuerpo latón pulido y cromado.
- Cartucho termostático de latón.
- Regulación automática de temperatura a 38°C
- Incluye mango de ducha, soporte y flexo.

	Código	Descripción	Código Barras	€ / Ud.
<b>Recambio</b>	<b>11111</b>	Cartucho termostático	8435195834123	<b>35,14</b>

## TERMOSTÁTICA BAÑO



Código	Medida	Caja	Código Barras	€ / Ud.
<b>1189</b>	-	1	8435195817621	<b>114,96</b>

- Cuerpo latón pulido y cromado.
- Cartucho termostático de latón.
- Regulación automática de temperatura a 38°C
- Incluye mango de ducha, soporte y flexo.

	Código	Descripción	Código Barras	€ / Ud.
<b>Recambio</b>	<b>11111</b>	Cartucho termostático	8435195834123	<b>35,14</b>



## GRIFERÍA HIGIÉNICA WC/BIDET

**Grifo higiénico y mangos**



**38**

## GRIFERÍA HIGIÉNICA WC/BIDET



### GRIFO HIGIÉNICO MEZCLADOR WC/BIDET MANGO ABS



Código	Medida	Caja	Código Barras	€ / Ud.
<b>1301</b>	-	1	8435195847802	<b>54,60</b>

- Agua fría y caliente.
- Flexo WC/Bidet PVC 1,2m.
- Mango WC/Bidet ABS.

### GRIFO HIGIÉNICO MEZCLADOR WC/BIDET MANGO LATÓN



Código	Medida	Caja	Código Barras	€ / Ud.
<b>1302</b>	-	1	8435195847819	<b>68,24</b>

- Agua fría y caliente.
- Flexo WC/Bidet PVC 1,2m.
- Mango WC/Bidet latón.

### MANGO ABS GRIFO HIGIÉNICO WC/BIDET



Código	Medida	Caja	Código Barras	€ / Ud.
<b>1303</b>	-	1	8435195847826	<b>4,40</b>

### MANGO LATÓN GRIFO HIGIÉNICO WC/BIDET



Código	Medida	Caja	Código Barras	€ / Ud.
<b>1304</b>	-	1	8435195847833	<b>16,80</b>





## COLUMNAS DE DUCHA

Columnas de ducha



40

## COLUMNAS DE DUCHA



### COLUMNA TELESCÓPICA DUCHA

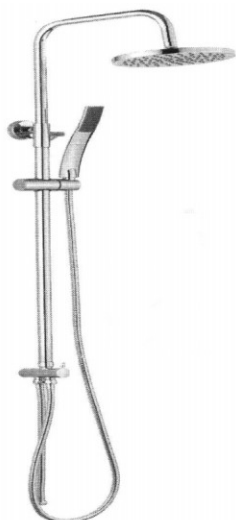

Código	Medida	Caja	Código Barras	€ / Ud.
<b>78301</b>	-	1	8435195828191	<b>165,88</b>

- Válida para bañera y ducha.
- Compatible con cualquier grifería.
- Extensible: 800 a 1350 mm.
- Tubo y soporte a pared de latón cromado.
- Rociador redondo de 20 cm.
- Flexo de acero reforzado.
- Soporte mango ducha deslizante.
- Incluye mango de ducha.

### COLUMNA TELESCÓPICA DUCHA CON TERMOSTÁTICA

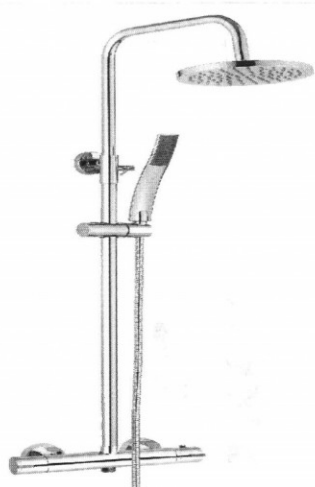

Código	Medida	Caja	Código Barras	€ / Ud.
<b>78302</b>	-	1	8435195828207	<b>270,85</b>

- Grifería termostática con mando y distribuidor.
- Extensible: 800 a 1350 mm.
- Tubo y soporte a pared de latón cromado.
- Rociador redondo de 20 cm.
- Flexo de acero reforzado.
- Soporte mango ducha deslizante.
- Incluye mango de ducha.

### COLUMNA TELESCÓPICA DUCHA CON MONOMANDO

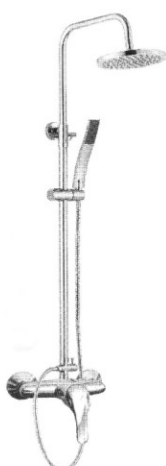



Código	Medida	Caja	Código Barras	€ / Ud.
<b>78303</b>	-	1	8435195828214	<b>229,98</b>

- Grifería monomando.
- Extensible: 800 a 1350 mm.
- Tubo y soporte a pared de latón cromado.
- Rociador redondo de 20 cm.
- Flexo de acero reforzado.
- Soporte mango ducha deslizante.
- Incluye mango de ducha.



## GRIFERÍA DE FREGADERO

<b>Monomandos</b>		<b>42</b>
<b>Baterías</b>		<b>45</b>
<b>Monoblocs</b>		<b>46</b>

# GRIFERÍA DE FREGADERO

Monomandos



## MONOMANDO FREGADERO CAÑO HORIZONTAL



Código	Medida	Caja	Código Barras	€ / Ud.
<b>1174</b>	-	1	8435195821475	<b>37,17</b>

- Caño tubo de latón conformado.
- Cuerpo latón pulido y cromado.
- Cartucho cerámico de 40 mm.
- Conexiones Aenor 10/100\*3/8\*35 cm.
- Atomizador de latón M 24/100.

Recambio	Código	Descripción	Código Barras	€ / Ud.
	<b>1110</b>	Cartucho 40 mm.	8435195821116	<b>3,96</b>

## MONOMANDO FREGADERO VERTICAL CAÑO TUBO



Código	Medida	Caja	Código Barras	€ / Ud.
<b>1175</b>	-	1	8435195815573	<b>50,95</b>

- Caño tubo de latón conformado.
- Cuerpo latón pulido y cromado.
- Cartucho cerámico de 40 mm.
- Conexiones Aenor 10/100\*3/8\*35 cm.
- Atomizador de latón M 24/100.

Recambio	Código	Descripción	Código Barras	€ / Ud.
	<b>1110</b>	Cartucho 40 mm.	8435195821116	<b>3,96</b>

## MONOMANDO FREGADERO VERTICAL CAÑO FUNDIDO



Código	Medida	Caja	Código Barras	€ / Ud.
<b>1076</b>	-	1	8435195825602	<b>52,95</b>

- Caño fundido de latón.
- Cuerpo latón pulido y cromado.
- Cartucho cerámico de 40 mm.
- Conexiones Aenor 10/100\*3/8\*35 cm.
- Atomizador de latón M 24/100.

Recambio	Código	Descripción	Código Barras	€ / Ud.
	<b>1110</b>	Cartucho 40 mm.	8435195821116	<b>3,96</b>

## MONOMANDO FREGADERO VERTICAL CAÑO CISNE



Código	Medida	Caja	Código Barras	€ / Ud.
<b>1194</b>	-	1	8435195825596	<b>51,20</b>

- Caño tubo de latón Ø 24 mm.
- Cuerpo latón pulido y cromado.
- Cartucho cerámico de 40 mm.
- Conexiones Aenor 10/100\*3/8\*35 cm.
- Atomizador de latón H 22/100.

Recambio	Código	Descripción	Código Barras	€ / Ud.
	<b>1110</b>	Cartucho 40 mm.	8435195821116	<b>3,96</b>



## GRIFERÍA DE FREGADERO

Monomandos

### MONOMANDO FREGADERO EXTRAÍBLE CAÑO BAJO



Código	Medida	Caja	Código Barras	€ / Ud.
<b>1177</b>	-	1	8435195825619	<b>67,72</b>

- Cuerpo latón pulido y cromado.
- Cartucho cerámico de 40 mm.
- Conexiones Aenor 10/100\*3/8\*35 cm.
- Mango de dos posiciones.

	Código	Descripción	Código Barras	€ / Ud.
<b>Recambio</b>	<b>1110</b>	Cartucho 40 mm.	8435195821116	<b>3,96</b>
	<b>78005</b>	Mango extraíble	8435195825862	<b>7,50</b>

### MONOMANDO FREGADERO EXTRAÍBLE CAÑO ALTO



Código	Medida	Caja	Código Barras	€ / Ud.
<b>1196</b>	-	1	8435195820485	<b>93,80</b>

- Cuerpo latón pulido y cromado.
- Cartucho cerámico de 40 mm.
- Conexiones Aenor 10/100\*3/8\*35 cm.
- Mango de dos posiciones.

	Código	Descripción	Código Barras	€ / Ud.
<b>Recambio</b>	<b>1110</b>	Cartucho 40 mm.	8435195821116	<b>3,96</b>
	<b>78005</b>	Mango extraíble	8435195825862	<b>7,50</b>

### MONOMANDO FREGADERO OSMOSIS



Código	Medida	Caja	Código Barras	€ / Ud.
<b>1179</b>	-	1	8435195828351	<b>123,43</b>

- Caño tubo de latón.
- Cuerpo latón pulido y cromado.
- Cartucho cerámico de 35 mm.
- Conexiones Aenor 10/100\*3/8\*35 cm.
- Atomizador de latón M 24/100 para mezclador
- Atomizador de latón M 18/100 para osmotizador.

	Código	Descripción	Código Barras	€ / Ud.
<b>Recambio</b>	<b>1112</b>	Cartucho 35 mm.	8435195821130	<b>3,96</b>

### MONOMANDO FREGADERO MINIMALISTA



Código	Medida	Caja	Código Barras	€ / Ud.
<b>1184</b>	-	1	8435195815627	<b>46,30</b>

- Caño tubo de latón Ø 24 mm.
- Cuerpo latón pulido y cromado.
- Cartucho cerámico de 40 mm.
- Conexiones Aenor 10/100\*3/8\*35 cm.

# GRIFERÍA DE FREGADERO

Monomandos



## MONOMANDO FREGADERO MURAL CAÑO ALTO TUBO

Código	Medida	Caja	Código Barras	€ / Ud.
<b>1176</b>	-	1	8435195825626	<b>57,60</b>



- Caño tubo de latón conformado.
- Cuerpo latón pulido y cromado.
- Cartucho cerámico de 40 mm.
- Atomizador de latón M 24/100.

	Código	Descripción	Código Barras	€ / Ud.
<b>Recambio</b>	<b>1110</b>	Cartucho 40 mm.	8435195821116	<b>3,96</b>

## MONOMANDO FREGADERO MURAL CAÑO ALTO FUNDIDO

Código	Medida	Caja	Código Barras	€ / Ud.
<b>1102</b>	-	1	8435195834130	<b>85,24</b>



- Caño fundido de latón.
- Cuerpo latón pulido y cromado.
- Cartucho cerámico de 40 mm.
- Atomizador de latón M 24/100.

	Código	Descripción	Código Barras	€ / Ud.
<b>Recambio</b>	<b>1110</b>	Cartucho 40 mm.	8435195821116	<b>3,96</b>

## MONOMANDO FREGADERO MURAL CAÑO BAJO TUBO

Código	Medida	Caja	Código Barras	€ / Ud.
<b>1178</b>	-	1	8435195825633	<b>57,60</b>



- Cuerpo latón pulido y cromado.
- Cartucho cerámico de 40 mm.
- Atomizador de latón M 24/100.

	Código	Descripción	Código Barras	€ / Ud.
<b>Recambio</b>	<b>1110</b>	Cartucho 40 mm.	8435195821116	<b>3,96</b>

## GRIFERÍA DE FREGADERO

### Baterías

#### BATERÍA FREGADERO CAÑO BAJO



Código	Medida	Caja	Código Barras	€ / Ud.
<b>99071</b>	11 cm.	1	8435195825640	<b>35,00</b>
<b>99072</b>	16 cm.	1	8435195825657	<b>36,00</b>

- Caño giratorio Ø 18 mm. Y longitud 22 cm. con filtro atomizador.
- Monturas cierre cerámico.
- Excéntricas de latón niquelado.

	Código	Descripción	Código Barras	€ / Ud.
<b>Recambio</b>	<b>1135</b>	Montura cerámica	8435195832228	<b>3,55</b>
	<b>78211</b>	Caño bajo	8435195832266	<b>5,45</b>
	<b>19045</b>	Volante metálico, tapa e índice	8435195832235	<b>4,45</b>

#### BATERÍA FREGADERO CAÑO ALTO



Código	Medida	Caja	Código Barras	€ / Ud.
<b>99090</b>	11 cm.	1	8435195817652	<b>35,00</b>
<b>99089</b>	16 cm.	1	8435195817669	<b>36,00</b>

- Caño giratorio Ø 18 mm. Y longitud 21 cm. con filtro atomizador.
- Monturas cierre cerámico.
- Excéntricas de latón niquelado.

	Código	Descripción	Código Barras	€ / Ud.
<b>Recambio</b>	<b>1135</b>	Montura cerámica	8435195832228	<b>3,55</b>
	<b>78210</b>	Caño alto	8435195832259	<b>4,98</b>
	<b>19045</b>	Volante metálico, tapa e índice	8435195832235	<b>4,45</b>

#### BATERÍA FREGADERO CAÑO ALTO MONTURA SOLETA



Código	Medida	Caja	Código Barras	€ / Ud.
<b>99073</b>	11 cm.	1	8435195828368	<b>36,00</b>
<b>99074</b>	16 cm.	1	8435195828375	<b>36,00</b>

- Caño giratorio Ø 18 mm. Y longitud 22 cm. con filtro atomizador.
- Monturas cierre soleta.
- Excéntricas de latón niquelado.

	Código	Descripción	Código Barras	€ / Ud.
<b>Recambio</b>	<b>78210</b>	Caño alto	8435195832259	<b>4,98</b>
	<b>19045</b>	Volante metálico, tapa e índice	8435195832235	<b>4,45</b>

#### BATERÍA FREGADERO CAÑO CORTO



Código	Medida	Caja	Código Barras	€ / Ud.
<b>99097</b>	11 cm.	1	8435195817676	<b>36,00</b>
<b>99098</b>	16 cm.	1	8435195817683	<b>36,00</b>

- Caño giratorio Ø 18 mm. Y longitud 16 cm. con filtro atomizador.
- Monturas cierre cerámico.
- Excéntricas de latón niquelado.

	Código	Descripción	Código Barras	€ / Ud.
<b>Recambio</b>	<b>1135</b>	Montura cerámica	8435195832228	<b>3,55</b>
	<b>78204</b>	Caño corto	8435195832242	<b>4,98</b>
	<b>19045</b>	Volante metálico, tapa e índice	8435195832235	<b>4,45</b>

# GRIFERÍA DE FREGADERO

Monoblocs



## MONOBLOC FREGADERO CAÑO TUBO



Código	Medida	Caja	Código Barras	€ / Ud.
<b>1096</b>	-	1	8435195817690	<b>42,10</b>



- Caño tubo de latón Ø 24 mm.
- Monturas cerámicas de media vuelta.
- Conexiones Aenor 10/100\*3/8\*35 cm.

	Código	Descripción	Código Barras	€ / Ud.
<b>Recambio</b>	<b>1135</b>	Montura cerámica	8435195832228	<b>3,55</b>
	<b>19045</b>	Volante metálico, tapa e índice	8435195832235	<b>4,45</b>





## GRIFERÍA DE UN AGUA

<b>Monomandos</b>		<b>48</b>
<b>Baterías</b>		<b>50</b>
<b>Office</b>		<b>51</b>

# GRIFERÍA DE UN AGUA

Monomandos



## MONOMANDO MURAL UN AGUA CAÑO VERTICAL GIRATORIO



Código	Medida	Caja	Código Barras	€ / Ud.
<b>1094</b>	1/2"	1	8435195833973	<b>26,68</b>

- Caño tubo recto giratorio.
- Cartucho cerámico de 25 mm.
- Entrada de agua rosca gas macho 1/2"
- Atomizador de latón

	Código	Descripción	Código Barras	€ / Ud.
<b>Recambio</b>	<b>1074</b>	Cartucho 25 mm.	8435195827972	<b>2,80</b>
	<b>78216</b>	Caño vertical	8435195847857	<b>12,00</b>

## MONOMANDO MURAL UN AGUA CAÑO VERTICAL GIRATORIO



Código	Medida	Caja	Código Barras	€ / Ud.
<b>1107</b>	1/2"	1	8435195834154	<b>35,73</b>

- Caño tubo recto giratorio.
- Cartucho cerámico de 25 mm.
- Entrada de agua rosca gas macho 1/2"
- Atomizador de latón H 22/100.

	Código	Descripción	Código Barras	€ / Ud.
<b>Recambio</b>	<b>1074</b>	Cartucho 25 mm.	8435195827972	<b>2,80</b>

## MONOMANDO MURAL UN AGUA CAÑO HORIZONTAL GIRATORIO



Código	Medida	Caja	Código Barras	€ / Ud.
<b>1099</b>	1/2"	1	8435195817645	<b>21,57</b>

- Caño tubo recto giratorio de 22 cm.
- Cartucho cerámico de 25 mm.
- Entrada de agua rosca gas macho 1/2"
- Atomizador de latón H 22/100.

	Código	Descripción	Código Barras	€ / Ud.
<b>Recambio</b>	<b>1074</b>	Cartucho 25 mm.	8435195827972	<b>2,80</b>

## MONOMANDO FREGADERO UN AGUA CAÑO VERTICAL GIRATORIO



Código	Medida	Caja	Código Barras	€ / Ud.
<b>1103</b>	1/2"	1	8435195834147	<b>39,03</b>

- Caño tubo recto giratorio.
- Cartucho cerámico de 25 mm.
- Entrada de agua rosca gas macho 1/2"
- Atomizador de latón H 22/100.

	Código	Descripción	Código Barras	€ / Ud.
<b>Recambio</b>	<b>1074</b>	Cartucho 25 mm.	8435195827972	<b>2,80</b>

# GRIFERÍA DE UN AGUA

*Monomandos*



## MONOMANDO MURAL LAVABO UN AGUA



Código	Medida	Caja	Código Barras	€ / Ud.
<b>1072</b>	1/2"	1	8435195828412	<b>22,95</b>

- Cartucho cerámico de 25 mm.
- Entrada de agua rosca gas macho 1/2"
- Atomizador de latón M 24/100.

	Código	Descripción	Código Barras	€ / Ud.
<b>Recambio</b>	<b>1078</b>	Cartucho 25 mm.	8435195834161	<b>2,92</b>

## MONOMANDO LAVABO UN AGUA



Código	Medida	Caja	Código Barras	€ / Ud.
<b>1071</b>	1/2"	1	8435195828405	<b>23,95</b>

- Cartucho cerámico de 25 mm.
- Entrada de agua rosca gas macho 1/2"
- Atomizador de latón M 24/100.

	Código	Descripción	Código Barras	€ / Ud.
<b>Recambio</b>	<b>1078</b>	Cartucho 25 mm.	8435195834161	<b>2,92</b>

# GRIFERÍA DE UN AGUA

Baterías



## GRIFO MURAL UN AGUA CAÑO ALTO HORIZONTAL



Código	Medida	Caja	Código Barras	€ / Ud.
<b>1069</b>	1/2"	1	8435195817638	<b>16,55</b>

- Caño giratorio Ø 18 mm. Y longitud 22 cm. con filtro atomizador.
- Monturas cierre cerámico.
- Volante metálico con índice azul.
- Entrada M 1/2"

	Código	Descripción	Código Barras	€ / Ud.
<b>Recambio</b>	<b>18510</b>	Montura cerámica	8435195834727	<b>2,30</b>
	<b>78213</b>	Caño alto	8435195828399	<b>4,98</b>
	<b>19045</b>	Volante metálico, tapa e índice	8435195832235	<b>4,45</b>

## GRIFO MURAL UN AGUA CAÑO BAJO HORIZONTAL



Código	Medida	Caja	Código Barras	€ / Ud.
<b>1068</b>	1/2"	1	8435195827927	<b>16,55</b>

- Caño giratorio Ø 18 mm. con filtro atomizador.
- Monturas cierre cerámico.
- Volante metálico con índice azul.
- Entrada M 1/2"

	Código	Descripción	Código Barras	€ / Ud.
<b>Recambio</b>	<b>18510</b>	Montura cerámica	8435195832228	<b>2,30</b>
	<b>78211</b>	Caño bajo	8435195832266	<b>5,45</b>
	<b>19045</b>	Volante metálico, tapa e índice	8435195832235	<b>4,45</b>

## GRIFO UN AGUA CAÑO VERTICAL



Código	Medida	Caja	Código Barras	€ / Ud.
<b>1098</b>	1/2"	1	8435195817713	<b>22,80</b>

- Caño giratorio Ø 18 mm. y longitud 26 cm. con filtro atomizador.
- Monturas cierre cerámico.
- Volante metálico con índice azul.
- Entrada M 1/2"

	Código	Descripción	Código Barras	€ / Ud.
<b>Recambio</b>	<b>1135</b>	Montura cerámica	8435195832228	<b>3,55</b>
	<b>78215</b>	Caño vertical	8435195834178	<b>14,40</b>
	<b>19045</b>	Volante metálico, tapa e índice	8435195832235	<b>4,45</b>

# GRIFERÍA DE UN AGUA

Office



## PLACA ATORNILLAR CROMADA



Código	Medida	Caja	Código Barras	€ / Ud.
<b>25519</b>	M-H 1/2"	10	8435195801989	<b>5,32</b>
<b>25521</b>	H-H 1/2"	10	8435195802009	<b>5,32</b>

## GRIFO LAVADORA SENCILLO



	Código	Medida	Caja	Código Barras	€ / Ud.
<b>Soleta</b>	<b>25004</b>	1/2" x 3/4"	10	8435195801774	<b>6,75</b>
<b>Cerámico</b>	<b>25007</b>	1/2" x 3/4"	10	8435195801781	<b>6,75</b>

- Entrada M 1/2" - Salida M 3/4"
- Volante metálico con índice azul.

	Código	Descripción	Código Barras	€ / Ud.
<b>Recambio</b>	<b>1133</b>	Montura soleta	8435195827972	<b>2,95</b>
	<b>1134</b>	Montura cerámica	8435195832211	<b>2,95</b>

## GRIFO LAVADORA DOBLE TIPO "Y"



Código	Medida	Caja	Código Barras	€ / Ud.
<b>25526</b>	1/2" x 3/4" x 3/4"	10	8435195820331	<b>11,81</b>

- Entrada M 1/2" - 2 Salidas M 3/4"
- Volante metálico con índice azul.
- Montura cierre soleta.

	Código	Descripción	Código Barras	€ / Ud.
<b>Recambio</b>	<b>1133</b>	Montura soleta	8435195827972	<b>2,95</b>

## GRIFO LAVADORA DOBLE



	Código	Medida	Caja	Código Barras	€ / Ud.
<b>Soleta</b>	<b>25006</b>	1/2" x 3/4"	10	8435195801804	<b>13,98</b>
<b>Cerámico</b>	<b>25008</b>	1/2" x 3/4"	10	8435195801811	<b>13,98</b>

- Entrada M 1/2" - Salida M 3/4"
- Volantes metálicos con índices azules.

	Código	Descripción	Código Barras	€ / Ud.
<b>Recambio</b>	<b>1133</b>	Montura soleta	8435195827972	<b>2,95</b>
	<b>1134</b>	Montura cerámica	8435195832211	<b>2,95</b>

## GRIFO LAVAVAJILLAS DOBLE



	Código	Medida	Caja	Código Barras	€ / Ud.
<b>Soleta</b>	<b>25010</b>	1/2" x 3/4" x 3/4"	10	8435195801835	<b>13,65</b>
<b>Cerámico</b>	<b>25011</b>	1/2" x 3/4" x 3/4"	10	8435195801842	<b>13,85</b>

- Entrada M 1/2" - 2 Salidas M 3/4"
- Volantes metálicos con índices azules.

	Código	Descripción	Código Barras	€ / Ud.
<b>Recambio</b>	<b>1133</b>	Montura soleta	8435195827972	<b>2,95</b>
	<b>1134</b>	Montura cerámica	8435195832211	<b>2,95</b>

## GRIFERÍA DE UN AGUA

Office



### "Y" BIFURCACIÓN SALIDA DOBLE



Código	Medida	Caja	Código Barras	€ / Ud.
<b>25509</b>	3/4"	10	8435195834185	<b>11,29</b>

- Entrada H 3/4" - Salidas M 3/4" M 3/4"
- Fabricado en latón y cromado.

### "Y" BIFURCACIÓN SALIDA DOBLE



Código	Medida	Caja	Código Barras	€ / Ud.
<b>58535</b>	3/4"	10	8435195834192	<b>1,80</b>

- Entrada H 3/4" - Salidas M 3/4" M 3/4"
- Fabricado en ABS.
- Tuerca de nylon.
- Junta de silicona.

### CONJUNTO GRIFO ADAPTADOR



	Código	Medida	Caja	Código Barras	€ / Ud.
<b>Conjunto</b>	<b>25507</b>	3/4" x 3/4" x 3/4"	10	8435195801897	<b>10,34</b>
<b>Adaptador</b>	<b>25508</b>	3/4" x 3/4"	10	8435195801903	<b>3,52</b>

- Montura cierre soleta.
- Volante metálico con índice azul.

### JUEGO GRIFOS DE BIDET



Código	Medida	Caja	Código Barras	€ / Ud.
<b>24010</b>	1/2"	2	8435195828238	<b>34,24</b>

- Juego de dos unidades.
- Montura cierre soleta.
- Entrada M 1/2"
- Volante metálico con un índice azul y un índice rojo.

### JUEGO GRIFOS DE LAVABO



Código	Medida	Caja	Código Barras	€ / Ud.
<b>24011</b>	1/2"	2	8435195801613	<b>19,94</b>

- Juego de dos unidades.
- Montura cierre cerámico.
- Entrada M 1/2"
- Volante metálico con un índice azul y un índice rojo.

	Código	Descripción	Código Barras	€ / Ud.
<b>Recambio</b>	<b>79005</b>	Atomizador	8435195834208	<b>0,77</b>
	<b>24008</b>	Montura cerámica	8435195834218	<b>3,68</b>

## GRIFO MURAL LAVABO CORTO



	Código	Medida	Caja	Código Barras	€ / Ud.
<b>Soleta</b>	<b>24005</b>	1/2 x 14 cm.	10	8435195801576	<b>8,74</b>
<b>Cerámico</b>	<b>24003</b>	1/2 x 14 cm.	10	8435195801552	<b>9,00</b>

- Entrada M 1/2".
- Salida con rompe-aguas.
- Volante metálico con índice azul.

	Código	Descripción	Código Barras	€ / Ud.
<b>Recambio</b>	<b>1133</b>	Montura soleta	8435195827972	<b>2,95</b>
	<b>1134</b>	Montura cerámica	8435195832211	<b>2,95</b>

## GRIFO MURAL LAVABO LARGO



	Código	Medida	Caja	Código Barras	€ / Ud.
<b>Soleta</b>	<b>24006</b>	1/2 x 17 cm.	10	8435195801583	<b>10,18</b>
<b>Cerámico</b>	<b>24004</b>	1/2 x 17 cm.	10	8435195801569	<b>10,18</b>

- Entrada M 1/2".
- Salida con rompe-aguas.
- Volante metálico con índice azul.

	Código	Descripción	Código Barras	€ / Ud.
<b>Recambio</b>	<b>1133</b>	Montura soleta	8435195827972	<b>2,95</b>
	<b>1134</b>	Montura cerámica	8435195832211	<b>2,95</b>

## GRIFO MURAL LAVABO



	Código	Medida	Caja	Código Barras	€ / Ud.
	<b>24007</b>	1/2"	10	8435195801590	<b>11,27</b>

- Montura cierre cerámico.
- Entrada M 1/2".
- Volante metálico con índice azul.

	Código	Descripción	Código Barras	€ / Ud.
<b>Recambio</b>	<b>1134</b>	Montura cerámica	8435195832211	<b>2,95</b>

## GRIFO MURAL LAVABO ITÁLICO



	Código	Medida	Caja	Código Barras	€ / Ud.
<b>Corto</b>	<b>25503</b>	1/2" x 12 cm.	10	8435195801859	<b>7,60</b>
<b>Largo</b>	<b>25504</b>	1/2" x 16 cm.	10	8435195801866	<b>9,30</b>

- Montura cierre soleta 1/2 vuelta.
- Entrada M 1/2".

	Código	Descripción	Código Barras	€ / Ud.
<b>Recambio</b>	<b>19020</b>	Montura itálico	8435195834222	<b>2,98</b>







## RECAMBIOS DE GRIFERÍA

Recambios de grifería



56

# RECAMBIOS GRIFERÍA



## PALANCAS



Código	Descripción	Código Barras	€ / Ud.
<b>19054</b>	Palanca medical corta	8435195801873	<b>9,47</b>
<b>1105</b>	Palanca medical larga	8435195834512	<b>37,46</b>

## CARTUCHOS



Código	Descripción	Código Barras	€ / Ud.
<b>1110</b>	Cartucho 40 mm. Sin distribuidor	8435195821116	<b>3,96</b>
<b>1111</b>	Cartucho 40 mm. Con distribuidor	8435195821123	<b>3,96</b>
<b>11111</b>	Cartucho termostático	8435195834123	<b>35,14</b>
<b>1112</b>	Cartucho 35 mm. Sin distribuidor	8435195821130	<b>3,96</b>
<b>1113</b>	Cartucho 35 mm. Con distribuidor	8435195825886	<b>3,96</b>
<b>1074</b>	Cartucho 25 mm.	8435195827972	<b>2,80</b>
<b>1078</b>	Cartucho 25 mm. - Art. 1071 - 1072	8435195834161	<b>2,92</b>

## MONTURAS



Código	Descripción	Código Barras	€ / Ud.
<b>1080</b>	Montura cerámica 1/2" - Serie Esfera	8435195834116	<b>2,70</b>
<b>1135</b>	Montura cerámica - Baterías	8435195832228	<b>3,55</b>
<b>18510</b>	Montura cerámica - Art. 1068 - 1069	8435195834727	<b>2,30</b>
<b>1133</b>	Montura soleta - Grifos lavadora/lavavajillas	8435195827972	<b>2,95</b>
<b>1134</b>	Montura cerámica - Grifos lavadora/lavavajillas	8435195832211	<b>2,95</b>
<b>24008</b>	Montura cerámica - Grifos lavabo	8435195834218	<b>3,68</b>
<b>19020</b>	Montura grifo itálico	8435195834222	<b>2,98</b>

## MANGOS



Código	Descripción	Código Barras	€ / Ud.
<b>78005</b>	Mango extraíble	8435195825862	<b>7,50</b>

## CAÑOS



Código	Descripción	Código Barras	€ / Ud.
<b>78211</b>	Caño bajo batería	8435195832266	<b>5,45</b>
<b>78210</b>	Caño alto batería	8435195832259	<b>4,98</b>
<b>78204</b>	Caño corto batería	8435195832242	<b>4,98</b>
<b>78213</b>	Caño alto - Art. 1069	8435195828399	<b>4,98</b>
<b>78215</b>	Caño vertical - Art. 1098	8435195834178	<b>14,40</b>
<b>78216</b>	Caño vertical - Art. 1094	8435195847857	<b>14,40</b>

## ACCESORIOS



Código	Descripción	Código Barras	€ / Ud.
<b>19045</b>	Volante metálico, tapa e índice	8435195832235	<b>4,45</b>
<b>79005</b>	Atomizador grifo lavabo	8435195834208	<b>0,77</b>
<b>78013</b>	Tuerca pestaña 3/4"	8435195832273	<b>1,60</b>
<b>99095</b>	Pestaña batería	8435195832280	<b>0,68</b>
<b>99096</b>	Tuerca caño 3/4"	8435195832297	<b>1,60</b>



## ACCESORIOS DE GRIFERÍA

<b>Fijaciones y excéntricas</b>		<b>58</b>
<b>Conexiones flexibles</b>		<b>59</b>
<b>Accesorios grifo extraíble</b>		<b>59</b>
<b>Cartuchos y monturas</b>		<b>60</b>
<b>Atomizadores</b>		<b>61</b>
<b>Adaptadores grifería</b>		<b>62</b>

## FIJACIÓN GRIFERÍA MONOMANDO 1 ESPÁRAGO



Código	Medida	Caja	Código Barras	€ / Ud.
<b>1091</b>	8 x 70 mm.	10	8435195820386	<b>0,96</b>
<b>1093</b>	8 x 45 mm.	10	8435195832303	<b>0,86</b>

- Tornillo y luna en acero inoxidable.
- Incluye junta estanqueidad para base de grifo.

## FIJACIÓN GRIFERÍA MONOMANDO 2 ESPÁRAGOS



Código	Medida	Caja	Código Barras	€ / Ud.
<b>1092</b>	2 Espárragos	10	8435195821062	<b>1,20</b>

- Tornillo y luna en acero inoxidable.
- Incluye junta estanqueidad para base de grifo.

## CONJUNTO EXCÉNTRICA Y FLORÓN



	Código	Medida	Caja	Código Barras	€ / Ud.
<b>Normal</b>	<b>25510</b>	3/4" x 1/2" x 10 mm.	10	8435195801934	<b>5,95</b>
<b>Gigante</b>	<b>25511</b>	3/4" x 1/2" x 25 mm.	10	8435195801941	<b>8,74</b>
<b>Súper gigante</b>	<b>25523</b>	3/4" x 1/2" x 45 mm.	10	8435195820508	<b>16,71</b>

- Cuerpo latón cromado.

## CUERPO EXCÉNTRICA



	Código	Medida	Caja	Código Barras	€ / Ud.
<b>Normal</b>	<b>25524</b>	3/4" x 1/2" x 10 mm.	10	8435195821420	<b>2,20</b>
<b>Gigante</b>	<b>25525</b>	3/4" x 1/2" x 25 mm.	10	8435195821437	<b>3,50</b>
<b>Súper gigante</b>	<b>25527</b>	3/4" x 1/2" x 45 mm.	10	8435195821444	<b>6,27</b>

- Cuerpo latón cromado.

## FLORÓN CROMADO PARA EXCÉNTRICA



	Código	Medida	Caja	Código Barras	€ / Ud.
<b>Normal</b>	<b>25530</b>	Ø 65 mm.	10	8435195801958	<b>0,88</b>
<b>Gigante</b>	<b>25531</b>	Ø 87 mm.	10	8435195801965	<b>1,44</b>
<b>Súper gigante</b>	<b>25532</b>	Ø 100 mm.	10	8435195820515	<b>3,37</b>

## ACCESORIOS GRIFERÍA



### JUNTA ATOMIZADOR



Código	Medida	Caja	Código Barras	€ / Ud.
<b>79013</b>	Macho 14 x 22 x 2	25	8435195823745	<b>0,046</b>
<b>79017</b>	Hembra 14 x 21 x 2	25	8435195823752	<b>0,046</b>

### FILTRO CON REJILLA



Código	Medida	Caja	Código Barras	€ / Ud.
<b>79033</b>	Filtro + Rejilla	25	8435195828109	<b>0,20</b>

### INSERTO PARA ESPUMANTES PLÁSTICO



Código	Medida	Caja	Código Barras	€ / Ud.
<b>79039</b>	M 24/100 - H 22/100	25	8435195825831	<b>0,19</b>

### JUEGO CONEXIÓN FLEXIBLE GRIFERÍA



Código	Medida	Caja	Código Barras	€ / Ud.
<b>56502</b>	H 3/8" x M 9/100 x 30 cm.	30	8435195806779	<b>4,64</b>
<b>56505</b>	H 3/8" x M 9/100 x 40 cm.	40	8435195806809	<b>5,31</b>
<b>56506</b>	H 3/8" x M 9/100 x 50 cm.	50	8435195806816	<b>5,44</b>
<b>56501</b>	H 3/8" x M 10/100 x 30 cm.	30	8435195806762	<b>3,79</b>
<b>56503</b>	H 3/8" x M 10/100 x 40 cm.	40	8435195806786	<b>4,77</b>
<b>56504</b>	H 3/8" x M 10/100 x 50 cm.	50	8435195806793	<b>5,20</b>

- Malla exterior acero inoxidable e interior EPDM atóxico.

### FLEJO GRIFO FREGADERO EXTRAÍBLE



Código	Medida	Caja	Código Barras	€ / Ud.
<b>50503</b>	H 1/2" x M 3/8" x 1,25 m.	1	8435195825848	<b>6,95</b>
<b>50507</b>	H 1/2" x M 15/100	1	8435195825855	<b>6,99</b>

- Malla exterior acero inoxidable e interior EPDM atóxico.

### FLEJO DE ACERO EXTENSIBLE



Código	Medida	Caja	Código Barras	€ / Ud.
<b>50003</b>	M 3/8 x H 1/2 x 1,70 m.	10	8435195825916	<b>6,72</b>

- Malla exterior acero inoxidable e interior EPDM atóxico.
- Longitud: 1,70 m. a 2,20 m.

### MANGO DUCHA FREGADERO EXTRAÍBLE



Código	Medida	Caja	Código Barras	€ / Ud.
<b>78005</b>	-	1	8435195825862	<b>7,50</b>

### PLOMADA GRIFO FREGADERO EXTRAÍBLE



Código	Medida	Caja	Código Barras	€ / Ud.
<b>50510</b>	-	1	8435195825879	<b>3,54</b>

## ACCESORIOS GRIFERÍA



### CARTUCHO MONOMANDO



Código	Medida	Caja	Código Barras	€ / Ud.
<b>1110</b>	Ø 40 mm. Sin distribuidor	1	8435195821116	<b>3,96</b>
<b>1111</b>	Ø 40 mm. Con distribuidor	1	8435195821123	<b>3,96</b>
<b>1112</b>	Ø 35 mm. Sin distribuidor	1	8435195821130	<b>3,96</b>
<b>1113</b>	Ø 35 mm. Con distribuidor	1	8435195825886	<b>3,96</b>

### INVERSOR MONOMANDO



Código	Medida	Caja	Código Barras	€ / Ud.
<b>1120</b>	-	1	8435195821147	<b>5,64</b>

### ENGANCHE PORTACADENAS



Código	Medida	Caja	Código Barras	€ / Ud.
<b>1090</b>	21 x 5,5	10	8435195825893	<b>0,14</b>

• Cromo.

### MONTURA CERÁMICA



Código	Medida	Caja	Código Barras	€ / Ud.
<b>1130</b>	90° x 1/2	1	8435195821178	<b>3,65</b>
<b>1131</b>	180° x 1/2	1	8435195821185	<b>3,65</b>
<b>1134</b>	Grifo lavadora	1	8435195832211	<b>2,95</b>
<b>1135</b>	Batería de fregadero	1	8435195832228	<b>3,55</b>

### MONTURA SOLETA



Código	Medida	Caja	Código Barras	€ / Ud.
<b>1132</b>	8 x 20 x 1/2	1	8435195825909	<b>3,65</b>
<b>1133</b>	Grifo lavadora	1	8435195834239	<b>2,95</b>

## FILTRO ATOMIZADOR



	Código	Medida	Caja	Código Barras	€ / Ud.
<b>Bolsa</b>	<b>79004</b>	Macho 18/100	100	8435195832310	<b>1,80</b>
	<b>79024</b>	Macho 20/100	100	8435195825565	<b>0,95</b>
	<b>79005</b>	Macho 22/100	100	8435195834208	<b>0,77</b>
	<b>79001</b>	Macho 24/100	100	8435195825534	<b>0,69</b>
	<b>79003</b>	Macho 28/100	100	8435195825558	<b>1,19</b>
	<b>79006</b>	Hembra 16/100	100	8435195834246	<b>1,58</b>
	<b>79023</b>	Hembra 18/100	100	8435195825770	<b>0,95</b>
	<b>79007</b>	Hembra 20/100	100	8435195842678	<b>0,90</b>
<b>79002</b>	Hembra 22/100	100	8435195825541	<b>0,75</b>	

	Código	Medida	Caja	Código Barras	€ / Ud.
<b>Blister</b>	<b>79010</b>	Macho 24/100	100	8435195812671	<b>0,79</b>
	<b>79012</b>	Macho 28/100	100	8435195812718	<b>1,30</b>
	<b>79011</b>	Hembra 22/100	100	8435195812695	<b>0,82</b>

	Código	Medida	Caja	Código Barras	€ / Ud.
<b>Oro / Bolsa</b>	<b>79020</b>	Macho 24/100	100	8435195812688	<b>1,30</b>
	<b>79022</b>	Macho 28/100	100	8435195812725	<b>1,76</b>
	<b>79021</b>	Hembra 22/100	100	8435195812701	<b>1,41</b>

- Fabricado en latón cromado. Disponible en color oro.
- Rejilla interior de acero inoxidable.
- Empaquetado individual.

## FILTRO ATOMIZADOR ECONOMIZADOR



	Código	Medida	Caja	Código Barras	€ / Ud.
<b>Blister</b>	<b>79030</b>	Macho 24/100	25	8435195821376	<b>0,96</b>
	<b>79031</b>	Hembra 22/100	25	8435195821383	<b>0,98</b>

	Código	Medida	Caja	Código Barras	€ / Ud.
<b>Blister</b>	<b>79032</b>	Limitador caudal ducha 1/2"	25	8435195821451	<b>1,90</b>

- Fabricado en latón cromado.
- Empaquetado individual.
- Reduce el caudal de agua un 50% aprox.

## FILTRO ATOMIZADOR CON RÓTULA



	Código	Medida	Caja	Código Barras	€ / Ud.
<b>Bolsa</b>	<b>79015</b>	Macho 24/100	10	8435195812749	<b>2,88</b>
	<b>79016</b>	Hembra 22/100	10	8435195812763	<b>2,88</b>

	Código	Medida	Caja	Código Barras	€ / Ud.
<b>Oro / Bolsa</b>	<b>79025</b>	Macho 24/100	10	8435195812756	<b>4,48</b>
	<b>79026</b>	Hembra 22/100	10	8435195812770	<b>5,88</b>

- Fabricado en latón cromado. Disponible en color oro.
- Rejilla interior de acero inoxidable.
- Empaquetado individual.

## ESPUMANTE FLEXIBLE



	Código	Medida			Caja	Código Barras	€ / Ud.
Blister	<b>79037</b>	Macho	24/100	Latón	20	8435195823707	<b>4,98</b>
	<b>79035</b>	Hembra	22/100	Latón	20	8435195825428	<b>5,85</b>
	<b>79036</b>	Hembra	22/100	Plástico	20	8435195823691	<b>4,78</b>

	Código	Medida			Caja	Código Barras	€ / Ud.
Blister	<b>79038</b>	Hembra	22/100	Plástico	20	8435195825794	<b>5,45</b>

- Incluye inserto, apto para grifería con roscas M 24/100 y H 22/100.
- Flexible
- Empaquetado individual.

## INSERTO PARA ESPUMANTES M 24/100 - H 22/100



	Código	Medida			Caja	Código Barras	€ / Ud.
ABS	<b>79039</b>	M 24/100 - H 22/100			20	8435195825831	<b>0,19</b>
Latón	<b>79040</b>	M 24/100 - H 22/100			20	8435195842692	<b>0,54</b>

## ECONOMIZADOR 2 POSICIONES CON RÓTULA



	Código	Medida			Caja	Código Barras	€ / Ud.
Blister	<b>79042</b>	Macho	24/100	Plástico	20	8435195825176	<b>3,10</b>
	<b>79041</b>	Hembra	22/100	Plástico	20	8435195823738	<b>3,10</b>

- 2 posiciones: atomizador y rociador.
- Orientable.
- Empaquetado individual.

## ADAPTADOR GRIFERÍA M 24/100



	Código	Medida			Caja	Código Barras	€ / Ud.
Blister	<b>79046</b>	M 24/100 x M 3/4"			20	8435195825800	<b>1,98</b>

- Filtro atomizador en el interior.
- Empaquetado individual.

## ADAPTADOR GRIFERÍA H 22/100



	Código	Medida			Caja	Código Barras	€ / Ud.
Blister	<b>79047</b>	H 22/100 x M 3/4"			25	8435195825817	<b>1,98</b>

- Filtro atomizador en el interior.
- Empaquetado individual.

## ADAPTADOR GRIFERÍA ENCHUFE RÁPIDO M 24/100



	Código	Medida			Caja	Código Barras	€ / Ud.
Blister	<b>79048</b>	M 24/100			10	8435195842715	<b>2,89</b>

- Filtro atomizador en el interior.
- Empaquetado individual.





## COMPLEMENTOS DE BAÑO

<b>Mangos de ducha</b>		<b>64</b>
<b>Flexos de ducha</b>		<b>67</b>
<b>Rociadores</b>		<b>68</b>
<b>Brazos y barras de ducha</b>		<b>70</b>
<b>Soportes de ducha</b>		<b>71</b>
<b>Barras de seguridad</b>		<b>72</b>



## COMPLEMENTOS DE BAÑO

### Mangos de ducha

#### MANGO DE DUCHA CRIS



Código	Descripción	Caja	Código Barras	€ / Ud.
<b>75001</b>	Blanco	10	8435195812312	<b>1,99</b>
<b>75002</b>	Negro	10	8435195812329	<b>1,99</b>

- Una única posición.
- Con codo ABS.
- Empaquetado en bolsa individual.

#### MANGO DE DUCHA GOLF



Código	Descripción	Caja	Código Barras	€ / Ud.
<b>75011</b>	Blanco	10	8435195812336	<b>1,36</b>

- Una única posición.
- Empaquetado en bolsa individual.

#### MANGO DE DUCHA BOSTON



Código	Descripción	Caja	Código Barras	€ / Ud.
<b>76001</b>	Blanco	10	8435195812343	<b>2,37</b>
<b>76002</b>	Negro	10	8435195812350	<b>2,37</b>

- Una única posición.
- Con codo ABS cromado.
- Empaquetado en bolsa individual.

#### MANGO DE DUCHA FORMENTOR



Código	Descripción	Caja	Código Barras	€ / Ud.
<b>77001</b>	Blanco	10	8435195812367	<b>3,98</b>
<b>77003</b>	Cromo	10	8435195812374	<b>5,52</b>

- Una única posición.
- Con gatillo.
- Empaquetado en bolsa individual.

#### MANGO DE DUCHA TER



Código	Descripción	Caja	Código Barras	€ / Ud.
<b>78001</b>	Blanco	10	8435195812404	<b>3,46</b>
<b>78002</b>	Negro	10	8435195812411	<b>2,99</b>
<b>78003</b>	Cromo	10	8435195812428	<b>5,88</b>

- Una única posición.
- Con codo ABS cromado.
- Empaquetado en bolsa individual.

## COMPLEMENTOS DE BAÑO

### Mangos de ducha



#### MANGO DE DUCHA ALCUDIA



Código	Descripción	Caja	Código Barras	€ / Ud.
<b>78101</b>	Blanco	10	8435195812435	<b>3,69</b>
<b>78103</b>	Negro	10	8435195812459	<b>3,32</b>
<b>78102</b>	Cromo	10	8435195812442	<b>3,49</b>

- Una única posición.
- Con membrana antical.
- Empaquetado en bolsa individual.

#### MANGO DE DUCHA TOSCANA



Código	Descripción	Caja	Código Barras	€ / Ud.
<b>78105</b>	Cromo	10	8435195832327	<b>5,95</b>

- Una única posición.
- Con membrana antical.
- Empaquetado en caja individual.

#### MANGO DE DUCHA VIENA



Código	Descripción	Caja	Código Barras	€ / Ud.
<b>78112</b>	Blanco y cromo	10	8435195847734	<b>6,50</b>

- Una única posición.
- Con membrana antical.
- Empaquetado en caja individual.

#### MANGO DE DUCHA MINIMALISTA



Código	Descripción	Caja	Código Barras	€ / Ud.
<b>78106</b>	Cromo	10	8435195820195	<b>4,26</b>

- Una única posición.
- Empaquetado en bolsa individual.

#### MANGO DE DUCHA MINIMALISTA CUADRADO

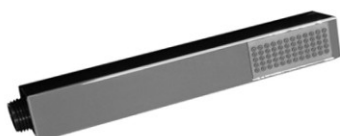

Código	Descripción	Caja	Código Barras	€ / Ud.
<b>78111</b>	Cromo	10	8435195842609	<b>6,53</b>

- Una única posición.
- Empaquetado en bolsa individual.



## COMPLEMENTOS DE BAÑO

### Mangos de ducha

#### MANGO DE DUCHA 5 POSICIONES



Código	Descripción	Caja	Código Barras	€ / Ud.
<b>78107</b>	Cromo	10	8435195820201	<b>6,97</b>

- Cinco posiciones.
- Membrana antical.
- Empaquetado en caja individual.

#### MANGO DE DUCHA PISA



Código	Descripción	Caja	Código Barras	€ / Ud.
<b>78108</b>	Cromo	10	8435195812466	<b>6,97</b>

- Cuatro posiciones.
- Membrana antical.
- Empaquetado en caja individual.

#### MANGO DE DUCHA ROMA



Código	Descripción	Caja	Código Barras	€ / Ud.
<b>99233</b>	Cromo	10	843519582473	<b>8,60</b>

- Cuatro posiciones.
- Membrana antical.
- Empaquetado en caja individual.

#### MANGO DE DUCHA PALMA



Código	Descripción	Caja	Código Barras	€ / Ud.
<b>78113</b>	Cromo	10	8435195847741	<b>7,90</b>

- Cinco posiciones.
- Membrana antical.
- Empaquetado en caja individual.

#### SET DE DUCHA CLARA



Código	Descripción	Caja	Código Barras	€ / Ud.
<b>78109</b>	Cromo	10	8435195832334	<b>12,58</b>

- Mango ducha cinco posiciones con membrana antical.
- Soporte cónico cromado.
- Flexo cromado reforzado de 1,70 m.
- Empaquetado en blister con colgador.

#### CODO DUCHA CROMADO



Código	Descripción	Caja	Código Barras	€ / Ud.
<b>77002</b>	Latón	10	8435195812381	<b>4,99</b>
<b>77005</b>	ABS	25	8435195812398	<b>0,72</b>



## COMPLEMENTOS DE BAÑO

### Flexos de ducha

#### FLEXO DE ACERO TUERCA GRAFILADA



Código	Medida	Caja	Código Barras	€ / Ud.
<b>50001</b>	1,5 m.	10	8435195806557	<b>3,43</b>
<b>50002</b>	2 m.	10	8435195806564	<b>4,29</b>

- Doble engatillado reforzado.
- Tuercas hexagonales rosca hembra 1/2".
- Tubo interior EPDM.

#### FLEXO DE ACERO TUERCA CÓNICA



Código	Medida	Caja	Código Barras	€ / Ud.
<b>50513</b>	1,20 m.	10	8435195839555	<b>4,81</b>
<b>50501</b>	1,5 m.	10	8435195806571	<b>3,99</b>
<b>50508</b>	1,75 m.	10	8435195806588	<b>4,19</b>
<b>50502</b>	2 m.	10	8435195806595	<b>4,68</b>

- Doble engatillado reforzado.
- Tuerca cónica y tuerca hexagonal rosca hembra 1/2".
- Tubo interior EPDM.

#### FLEXO DE ACERO EXTENSIBLE



Código	Medida	Caja	Código Barras	€ / Ud.
<b>50504</b>	1,75 m. a 2,40 m.	10	8435195806601	<b>7,89</b>

- Doble engatillado reforzado.
- Tuerca cónica y tuerca hexagonal rosca hembra 1/2".
- Tubo interior EPDM.

#### FLEXO DE PVC TUERCA CÓNICA



	Código	Medida	Caja	Código Barras	€ / Ud.
<b>Blanco</b>	<b>52001</b>	1,5 m.	10	8435195806649	<b>3,14</b>
	<b>52002</b>	2 m.	10	8435195806656	<b>3,84</b>



	Código	Medida	Caja	Código Barras	€ / Ud.
<b>Negro y cromo</b>	<b>52003</b>	1,5 m.	10	8435195827934	<b>2,51</b>
	<b>52004</b>	2 m.	10	8435195827941	<b>3,35</b>

- Tuerca cónica y tuerca hexagonal rosca hembra 1/2".



## COMPLEMENTOS DE BAÑO

### Rociadores

#### ROCIADOR DUCHA



Código	Medida	Caja	Código Barras	€ / Ud.
<b>78402</b>	1/2" x Ø 60 mm.	20	8435195812527	<b>2,15</b>

- Fabricado en latón cromado.



Código	Medida	Caja	Código Barras	€ / Ud.
<b>78404</b>	1/2" x Ø 90 mm.	20	8435195812534	<b>2,89</b>

- Fabricado en latón cromado.



Código	Medida	Caja	Código Barras	€ / Ud.
<b>78403</b>	1/2" x Ø 50 mm.	20	8435195812541	<b>0,47</b>

- Fabricado en ABS blanco.



Código	Medida	Caja	Código Barras	€ / Ud.
<b>78407</b>	1/2" Pared	10	8435195825930	<b>28,71</b>

- Fabricado en latón cromado.
- Antivandálico.

#### ROCIADOR DUCHA CON RÓTULA



Código	Medida	Caja	Código Barras	€ / Ud.
<b>79018</b>	1/2" X Ø 43 mm.	10	8435195824629	<b>11,52</b>

- Fabricado en latón cromado.
- Rótula y rosca en latón cromado.



Código	Medida	Caja	Código Barras	€ / Ud.
<b>79014</b>	1/2" x Ø 60 mm.	10	8435195812664	<b>5,81</b>

- Fabricado en ABS cromado.
- Rótula y rosca en latón cromado.

#### ROCIADOR DUCHA CLARA



Código	Medida	Caja	Código Barras	€ / Ud.
<b>78408</b>	1/2"	10	8435195820225	<b>6,60</b>

- Fabricado en ABS cromado.
- Cinco posiciones.
- Membrana antical.



Código	Medida	Caja	Código Barras	€ / Ud.
<b>78411</b>	1/2"	10	8435195825947	<b>6,60</b>

- Fabricado en ABS cromado.
- Tres posiciones.
- Membrana antical.



## COMPLEMENTOS DE BAÑO

### Rociadores

#### ROCIADOR DUCHA REDONDO ABS



Código	Medida	Caja	Código Barras	€ / Ud.
<b>78409</b>	1/2" x Ø 200 mm.	10	8435195820232	<b>14,92</b>

- Fabricado en ABS cromado.
- Rótula de latón cromado.
- Membrana antical.
- Empaquetado en caja blanca individual.

#### ROCIADOR DUCHA CUADRADO ABS

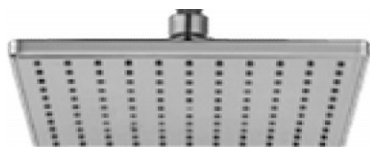

Código	Medida	Caja	Código Barras	€ / Ud.
<b>78412</b>	1/2" X Ø 200 mm.	10	8435195842623	<b>17,44</b>

- Fabricado en ABS cromado.
- Rótula de latón cromado.
- Extrafino 1 cm.
- Membrana antical.
- Empaquetado en caja blanca individual.

#### ROCIADOR DUCHA REDONDO LATÓN



Código	Medida	Caja	Código Barras	€ / Ud.
<b>78413</b>	1/2" x Ø 200 mm.	10	8435195847659	<b>17,60</b>

- Fabricado en latón cromado.
- Rótula y rosca de latón cromado.
- Membrana antical.
- Empaquetado en caja blanca individual.

#### ROCIADOR DUCHA CUADRADO LATÓN



Código	Medida	Caja	Código Barras	€ / Ud.
<b>78414</b>	1/2" x Ø 200 mm.	10	8435195847666	<b>17,60</b>

- Fabricado en latón cromado.
- Rótula y rosca de latón cromado.
- Membrana antical.
- Empaquetado en caja blanca individual.

#### ROCIADOR DUCHA ESTRELLA



Código	Medida	Caja	Código Barras	€ / Ud.
<b>78410</b>	1/2" X Ø 220 mm.	10	8435195820249	<b>28,40</b>

- Fabricado en latón cromado.
- Rótula y rosca de latón cromado.
- Membrana antical.
- Empaquetado en caja blanca individual.



## COMPLEMENTOS DE BAÑO

### Brazos de ducha

#### BRAZO DE DUCHA



Código	Medida	Caja	Código Barras	€ / Ud.
<b>78201</b>	1/2" x 250 mm.	10	8435195812480	<b>6,64</b>
<b>78202</b>	1/2" x 300 mm.	10	8435195812497	<b>6,97</b>
<b>78205</b>	1/2" x 400 mm.	10	8435195812503	<b>7,68</b>

- Fabricado en acero inoxidable.
- Cromado.

#### BRAZO DE DUCHA FUNDIDO



Código	Medida	Caja	Código Barras	€ / Ud.
<b>78206</b>	1/2" x 150 mm.	10	8435195825923	<b>4,96</b>

- Cromado.
- Plafón cromado ABS.

#### BRAZO DE DUCHA MANANTIAL



Código	Medida	Caja	Código Barras	€ / Ud.
<b>78207</b>	1/2" x 370 mm.	10	8435195828009	<b>11,43</b>

- Fabricado en acero inoxidable.
- Cromado.
- Diametro tubo Ø 20 mm.
- Plafón cromado.

#### BRAZO DE DUCHA CURVO



Código	Medida	Caja	Código Barras	€ / Ud.
<b>78209</b>	1/2"	10	8435195820218	<b>3,32</b>

- Fabricado en acero inoxidable.
- Cromado.
- Diametro tubo Ø 20 mm.
- Plafón cromado.

#### BRAZO DE DUCHA TECHO



Código	Medida	Caja	Código Barras	€ / Ud.
<b>78208</b>	1/2" x 200 mm.	10	8435195847840	<b>7,15</b>

- Fabricado en acero inoxidable.
- Cromado.
- Diametro tubo Ø 20 mm.
- Plafón cromado.

#### BARRA DE DUCHA DESLIZANTE



Código	Medida	Caja	Código Barras	€ / Ud.
<b>99235</b>	Ø 28 mm. x 61 cm.	5	8435195812510	<b>11,99</b>

- Cromado.
- Jabonera deslizante.



## COMPLEMENTOS DE BAÑO

### Soportes de ducha



#### SOPORTE DE DUCHA GIRATORIO



	Código	Descripción	Caja	Código Barras	€ / Ud.
ABS	<b>78601</b>	Negro	10	8435195812558	<b>1,48</b>
	<b>78602</b>	Blanco	10	8435195812565	<b>1,49</b>
	<b>78603</b>	Cromo	10	8435195812572	<b>2,40</b>

• Para flexos de ducha con tuerca cónica.

#### SOPORTE DE DUCHA GIRATORIO LUNA



	Código	Descripción	Caja	Código Barras	€ / Ud.
ABS	<b>78609</b>	Cromo	10	8435195832341	<b>2,40</b>

• Para flexos de ducha con tuerca cónica.

#### SOPORTE DE DUCHA BAYONETA

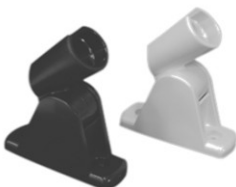

	Código	Descripción	Caja	Código Barras	€ / Ud.
ABS	<b>78606</b>	Blanco	10	8435195812596	<b>1,96</b>
	<b>78604</b>	Cromo	10	8435195825954	<b>3,97</b>

• Para flexos de ducha con tuerca cónica.

#### SOPORTE DE DUCHA HORQUILLA



	Código	Descripción	Caja	Código Barras	€ / Ud.
ABS	<b>78607</b>	Cromo	10	8435195812602	<b>2,17</b>

	Código	Descripción	Caja	Código Barras	€ / Ud.
Metal	<b>78608</b>	Cromo	10	8435195825978	<b>7,98</b>

• Para flexos de ducha con tuerca redonda o hexagonal.

#### SOPORTE DE DUCHA HORQUILLA CROMO



	Código	Descripción	Caja	Código Barras	€ / Ud.
ABS	<b>78804</b>	Cromo	10	8435195842630	<b>2,17</b>

• Para flexos de ducha con tuerca cónica.

#### SOPORTE DE DUCHA



	Código	Descripción	Caja	Código Barras	€ / Ud.
Metal	<b>78801</b>	Cromo - Con toma	10	8435195812619	<b>10,89</b>

	Código	Descripción	Caja	Código Barras	€ / Ud.
Metal	<b>78802</b>	Cromo - Sin toma	10	8435195812626	<b>3,16</b>
ABS	<b>78803</b>	Cromo - Sin toma	10	8435195812633	<b>3,46</b>
ABS	<b>78805</b>	Blanco - Sin toma	10	8435195812657	<b>1,20</b>

• Para flexos de ducha con tuerca redonda o hexagonal.



## COMPLEMENTOS DE BAÑO

### Soportes de ducha

#### SOPORTE DE DUCHA CROMO

	Código	Descripción	Caja	Código Barras	€ / Ud.
<b>ABS</b>	<b>78806</b>	Cromo	10	8435195812558	<b>1,92</b>



- Para flexos de ducha con tuerca cónica.

#### CODO CON TOMA PARA FLEXO DE DUCHA

Código	Medida	Caja	Código Barras	€ / Ud.
<b>78807</b>	M 1/2" x M 1/2"	10	8435195842654	<b>11,70</b>



#### SOPORTE CON TOMA PARA FLEXO DE DUCHA

Código	Medida	Caja	Código Barras	€ / Ud.
<b>78808</b>	M 1/2" x M 1/2"	10	8435195842661	<b>9,43</b>



#### BARRA DE SEGURIDAD PARA BAÑO-DUCHA

Código	Medida	Caja	Código Barras	€ / Ud.
<b>78809</b>	30 cm.	1	8435195832358	<b>23,10</b>
<b>78810</b>	40 cm.	1	8435195832365	<b>27,06</b>
<b>78811</b>	50 cm.	1	8435195832372	<b>30,03</b>



- Plafones y fijaciones de latón.
- Ø 25 mm.
- Empaquetado en blister individual.



## VÁLVULAS DESAGÜE

<b>Válvulas click-clack</b>		<b>74</b>
<b>Válvulas automáticas y manuales</b>		<b>76</b>
<b>Válvulas bañera y ducha</b>		<b>77</b>
<b>Tapa orificios y tapones</b>		<b>79</b>
<b>Cadena y anillas</b>		<b>80</b>



## VÁLVULAS DESAGÜE

Válvulas Click-Clack

### VÁLVULA DESAGÜE CLICK-CLACK LAVABO / BIDÉ ABS



Código	Medida	Caja	Código Barras	€ / Ud.
<b>25561</b>	1 1/4"	10	8435195821581	<b>5,86</b>

- Válvula universal **con y sin rebosadero.**
- Fabricada en ABS cromado.

### VÁLVULA DESAGÜE CLICK-CLACK LAVABO / BIDÉ



Código	Medida	Caja	Código Barras	€ / Ud.
<b>25500</b>	1 1/4"	10	8435195821567	<b>11,95</b>

- Válvula universal **con y sin rebosadero.**
- Fabricada en latón cromado.

	Código	Descripción	Código Barras	€ / Ud.
<b>Recambio</b>	<b>25528</b>	Junta ABS	8435195825985	<b>0,40</b>

### VÁLVULA DESAGÜE CLICK-CLACK LAVABO / BIDÉ LUJO



Código	Medida	Caja	Código Barras	€ / Ud.
<b>25501</b>	1 1/4"	10	8435195821574	<b>14,96</b>

- Válvula universal **con y sin rebosadero.**
- Fabricada en latón cromado.

### VÁLVULA DESAGÜE CLICK-CLACK LAVABO / BIDÉ LUJO



Código	Medida	Caja	Código Barras	€ / Ud.
<b>25502</b>	1 1/4"	10	8435195825992	<b>15,68</b>

- Válvula universal **con y sin rebosadero.**
- Fabricada en latón cromado.
- Tapón cuadrado.



## VÁLVULAS DESAGÜE

Válvulas Click-Clack

### VÁLVULA DESAGÜE CLICK-CLACK LAVABO / BIDÉ



Código	Medida	Caja	Código Barras	€ / Ud.
<b>25513</b>	1 1/4"	10	8435195817768	<b>9,98</b>

- Válvula universal **sin rebosadero.**
- Fabricada en latón cromado.

### VÁLVULA DESAGÜE CLICK-CLACK LAVABO / BIDÉ



Código	Medida	Caja	Código Barras	€ / Ud.
<b>25515</b>	1 1/4"	10	8435195817775	<b>11,20</b>

- Válvula universal **con rebosadero.**
- Fabricada en latón cromado.

### VÁLVULA DESAGÜE CLICK-CLACK BAÑERA



Código	Medida	Caja	Código Barras	€ / Ud.
<b>25516</b>	1 1/2"	10	8435195817782	<b>9,89</b>

- Fabricada en latón cromado.

### VÁLVULA DESAGÜE CLICK-CLACK BIDÉ



Código	Medida	Caja	Código Barras	€ / Ud.
<b>25529</b>	1 1/4"	10	8435195825374	<b>14,91</b>

- Fabricada en latón cromado.

# VÁLVULAS DESAGÜE



## VÁLVULA DESAGÜE AUTOMÁTICA LAVABO / BIDÉ



Código	Medida	Caja	Código Barras	€ / Ud.
<b>25512</b>	1 1/4"	2	8435195817744	<b>9,89</b>

- Fabricada en latón cromado.

## VÁLVULA DESAGÜE AUTOMÁTICA LAVABO ABS



Código	Medida	Caja	Código Barras	€ / Ud.
<b>44026</b>	1 1/4"	2	8435195837070	<b>6,70</b>

- Fabricada en ABS cromado.

## VARILLA VÁLVULA DESAGÜE AUTOMÁTICA LAVABO



Código	Medida	Caja	Código Barras	€ / Ud.
<b>44027</b>	-	2	8435195837087	<b>1,11</b>

- Fabricada en acero inoxidable.

## VÁLVULA DESAGÜE LAVABO / BIDÉ



Código	Medida	Caja	Código Barras	€ / Ud.
<b>25579</b>	1 1/4" x 70 Ø	100	8435195832488	<b>2,74</b>

## VÁLVULA DESAGÜE LAVABO / BIDÉ



Código	Medida	Caja	Código Barras	€ / Ud.
<b>25580</b>	1 1/2" x 70 Ø	100	8435195832495	<b>2,74</b>

## REJILLA FILTRO INOX PARA VÁLVULA DESAGÜE



Código	Medida	Caja	Código Barras	€ / Ud.
<b>85129</b>	68 mm.	2	8435195844825	<b>0,78</b>

- Filtro de acero superponible para válvulas de desagüe de Ø 70 mm.



## VÁLVULAS DESAGÜE

Válvulas bañera/ducha

### CONJUNTO BAÑERA CON REBOSADERO HORIZONTAL CLICK CLACK



Código	Medida	Caja	Código Barras	€ / Ud.
<b>25591</b>	1 1/2" x 40 mm. Ø	25	8435195847727	<b>22,75</b>

- Incluye junta reductora de Ø 40 mm. a Ø 32 mm.
- Tapón click clack.
- Salida horizontal orientable.

### CONJUNTO BAÑERA CON REBOSADERO HORIZONTAL



Código	Medida	Caja	Código Barras	€ / Ud.
<b>25514</b>	1 1/2" x 40 mm. Ø	25	8435195817751	<b>8,23</b>

- Cadena de bolas en latón cromado.
- Incluye junta reductora de Ø 40 mm. a Ø 32 mm.

### CONJUNTO BAÑERA CON REBOSADERO SIFÓNICO



Código	Medida	Caja	Código Barras	€ / Ud.
<b>25563</b>	1 1/2" x 40 mm. Ø	25	8435195835724	<b>8,84</b>

- Cadena de bolas en latón cromado.
- Incluye junta reductora de Ø 40 mm. a Ø 32 mm.

### VÁLVULA DUCHA SIFÓNICA EXTRAPLANA SIN EMBELLECEDOR



Código	Medida	Caja	Código Barras	€ / Ud.
<b>25595</b>	1 1/2" x 40 mm. Ø	10	8435195835762	<b>13,60</b>

- Sin embellecedor.
- Juego de tornillos en latón.
- Sifón totalmente extraíble para facilitar su limpieza.
- Gran caudal de desagüe.

### VÁLVULA DUCHA SIFÓNICA EXTRAPLANA CON EMBELLECEDOR



Código	Medida	Caja	Código Barras	€ / Ud.
<b>25596</b>	1 1/2" x 40 mm. Ø	10	8435195835779	<b>18,24</b>

- Con embellecedor cromado extraplano 110 mm Ø.
- Juego de tornillos en latón.
- Sifón totalmente extraíble para facilitar su limpieza.
- Gran caudal de desagüe.

# VÁLVULAS DESAGÜE

Válvulas bañera/ducha



## VÁLVULA PLATO DE DUCHA PARA BOTE SIFÓNICO Ø 80



Código	Medida	Caja	Código Barras	€ / Ud.
<b>25582</b>	1 1/4" x 32 mm. Ø	25	8435195832518	<b>2,94</b>

- Con orificio de 60 mm Ø.
- Con rejilla en acero inoxidable de 80 mm Ø.
- Salida horizontal 40 mm. Ø con reductora a 32 mm. Ø.

## VÁLVULA PLATO DE DUCHA PARA BOTE SIFÓNICO Ø 115



Código	Medida	Caja	Código Barras	€ / Ud.
<b>25586</b>	1 1/2" x 40 mm. Ø	10	8435195832556	<b>3,52</b>

- Válvula sifónica con orificio de 90 mm. Ø.
- Con rejilla en acero inoxidable de 115 mm Ø.
- Salida horizontal 40 mm. Ø con reductora a 32 mm. Ø.

## VÁLVULA PLATO DE DUCHA SIFÓNICA HORIZONTAL Ø 80



Código	Medida	Caja	Código Barras	€ / Ud.
<b>25583</b>	1 1/2" x 40 mm. Ø	25	8435195832525	<b>3,36</b>

- Con orificio de 60 mm. Ø.
- Con rejilla en acero inoxidable de 80 mm Ø.
- Salida orientable 40 mm. Ø con reductora a 32 mm. Ø.

## VÁLVULA PLATO DE DUCHA REGISTRABLE Ø 90



Código	Medida	Caja	Código Barras	€ / Ud.
<b>25584</b>	1 1/2" x 40 mm. Ø	10	8435195832532	<b>6,98</b>

- Válvula sifónica con orificio de 60 mm. Ø.
- Con embellecedor champiñón en acero inoxidable de 90 mm. Ø.
- Salida horizontal 40 mm. Ø con reductora a 32 mm. Ø.

## VÁLVULA PLATO DE DUCHA REGISTRABLE Ø 120



Código	Medida	Caja	Código Barras	€ / Ud.
<b>25585</b>	1 1/2" x 40 mm. Ø	10	8435195832549	<b>16,47</b>

- Válvula sifónica con orificio de 90 mm. Ø.
- Con embellecedor champiñón en acero inoxidable de 120 mm. Ø.
- Salida horizontal 40 mm. Ø con reductora a 32 mm. Ø.



# VÁLVULAS DESAGÜE

Accesorios



## TAPA ORIFICIOS LAVABO / BIDÉ



	Código	Descripción	Caja	Código Barras	€ / Ud.
<b>Inox.</b>	<b>74501</b>	Cromo con enganche	25	8435195812282	<b>1,17</b>



	Código	Descripción	Caja	Código Barras	€ / Ud.
<b>ABS</b>	<b>74502</b>	Blanco - Ciego	25	8435195812299	<b>0,35</b>
	<b>74503</b>	Cromo - Ciego	25	8435195812305	<b>0,49</b>



	Código	Descripción	Caja	Código Barras	€ / Ud.
<b>ABS</b>	<b>74506</b>	Blanco	25	8435195832563	<b>0,67</b>
	<b>74507</b>	Cromo	25	8435195832570	<b>0,89</b>



	Código	Descripción	Caja	Código Barras	€ / Ud.
<b>ABS</b>	<b>74505</b>	Embellecador cromo	25	8435195828092	<b>0,74</b>

## TAPONES DE CAUCHO



	Código	Medida	Caja	Código Barras	€ / Ud.
	<b>85001</b>	24 Ø	25	8435195814729	<b>0,41</b>
	<b>85002</b>	28 Ø	25	8435195814736	<b>0,41</b>
	<b>85003</b>	30 Ø	25	8435195814743	<b>0,41</b>
	<b>85004</b>	32 Ø	25	8435195814750	<b>0,44</b>
	<b>85005</b>	34 Ø	25	8435195814767	<b>0,45</b>
	<b>85006</b>	36 Ø	25	8435195814774	<b>0,47</b>
	<b>85007</b>	38 Ø	25	8435195814781	<b>0,48</b>
	<b>85008</b>	40 Ø	25	8435195814798	<b>0,48</b>
	<b>85009</b>	42 Ø	25	8435195814804	<b>0,49</b>
	<b>85010</b>	44 Ø	25	8435195814811	<b>0,53</b>
	<b>85011</b>	47 Ø	25	8435195814828	<b>0,60</b>
	<b>85012</b>	50 Ø	25	8435195814835	<b>0,66</b>
	<b>85013</b>	51 Ø	25	8435195814842	<b>0,69</b>
<b>Universal fregadero</b>	<b>85014</b>	55 Ø	25	8435195814859	<b>0,66</b>
	<b>85015</b>	61 Ø	25	8435195814866	<b>0,78</b>
<b>Universal TEKA - JIMTEN</b>	<b>85017</b>	46 Ø	25	8435195814880	<b>0,52</b>

• Con embellecedor en acero inoxidable.

# VÁLVULAS DESAGÜE

Accesorios



## ROLLO CADENA DE BOLAS CROMADA



Código	Medida	Caja	Código Barras	€ / Ud.
<b>85101</b>	3,2 mm. Ø x 50 m.	1	8435195815078	<b>54,50</b>
<b>85102</b>	3,8 mm. Ø x 50 m.	1	8435195815085	<b>68,50</b>

## CADENA DE BOLAS CROMADA CON ANILLAS



Código	Medida	Caja	Código Barras	€ / Ud.
<b>85103</b>	3,2 mm. Ø x 27 cm.	25	8435195815092	<b>0,62</b>
<b>85104</b>	3,2 mm. Ø x 42 cm.	25	8435195815108	<b>0,71</b>

Código	Medida	Caja	Código Barras	€ / Ud.
<b>85105</b>	3,8 mm. Ø x 27 cm.	25	8435195815115	<b>0,72</b>
<b>85106</b>	3,8 mm. Ø x 42 cm.	25	8435195815122	<b>0,86</b>

## ANILLA TRIÁNGULO



	Código	Medida	Caja	Código Barras	€ / Ud.
<b>Inox.</b>	<b>85110</b>	Pequeña	100	8435195815139	<b>0,04</b>
	<b>85112</b>	Grande	100	8435195815153	<b>0,04</b>

## ANILLA LLAVERO



	Código	Descripción	Caja	Código Barras	€ / Ud.
<b>Inox.</b>	<b>85117</b>	Pequeña	100	8435195823677	<b>0,06</b>
	<b>85111</b>	Grande	100	8435195815146	<b>0,10</b>

## ENGANCHE "U"



	Código	Descripción	Caja	Código Barras	€ / Ud.
<b>Inox.</b>	<b>85113</b>	3,2 mm.	100	8435195815160	<b>0,06</b>
	<b>85114</b>	3,8 mm.	100	8435195815177	<b>0,06</b>

## ENGANCHE LLAVERO TUBULAR



	Código	Descripción	Caja	Código Barras	€ / Ud.
<b>Inox.</b>	<b>85115</b>	3,2 mm.	100	8435195815184	<b>0,06</b>
	<b>85116</b>	3,8 mm.	100	8435195815191	<b>0,06</b>



## FILTROS DESAGÜE

**Filtros desagüe**



**82**

## FILTROS DESAGÜE



### FILTRO DESAGÜE ACERO INOXIDABLE



Código	Medida	Caja	Código Barras	€ / Ud.
<b>85130</b>	50 x 30 Lavabo / Bidé	10	8435195815078	<b>0,49</b>
<b>85131</b>	65 x 40 Fregadero / Bañera	10	8435195832594	<b>0,56</b>
<b>85132</b>	80 x 50 Fregadero / Bañera	10	8435195832600	<b>0,76</b>

### FILTRO DESAGÜE BLANCO



Código	Medida	Caja	Código Barras	€ / Ud.
<b>85135</b>	65 x 40 Fregadero / Bañera	10	8435195832617	<b>1,23</b>
<b>85136</b>	80 x 50 Fregadero / Bañera	10	8435195832624	<b>1,59</b>

### FILTRO DESAGÜE CAZOLETA



Código	Medida	Caja	Código Barras	€ / Ud.
<b>85140</b>	65 x 40 Fregadero / Bañera	10	8435195832631	<b>0,82</b>

### FILTRO DESAGÜE TEKA



Código	Medida	Caja	Código Barras	€ / Ud.
<b>85141</b>	Inox. - 81 x 31 Fregadero	10	8435195832648	<b>2,31</b>
<b>85142</b>	Blanco - 81 x 31 Fregadero	10	8435195832655	<b>2,44</b>

### FILTRO DESAGÜE TEKA CON EJE CENTRAL



Código	Medida	Caja	Código Barras	€ / Ud.
<b>85143</b>	81 x 31 Fregadero	10	8435195832662	<b>3,91</b>



## SIFONES DESAGÜE Y ACCESORIOS

**Sifones desagüe**



**84**

**Accesorios**



**87**

# SIFONES DESAGÜE



## SIFÓN BOTELLA CROMADO



Código	Medida	Caja	Código Barras	€ / Ud.
<b>63520</b>	1 1/4" x 32 mm Ø	10	8435195809800	<b>16,80</b>

- Fabricado en latón cromado.
- Para lavabo y bidé.
- Sin válvula.

## SIFÓN BOTELLA MINIMALISTA

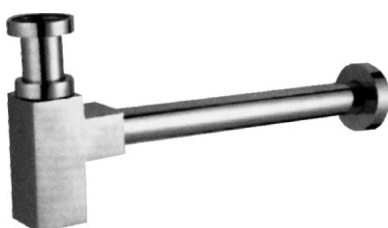

Código	Medida	Caja	Código Barras	€ / Ud.
<b>63515</b>	1 1/4" x 32 mm Ø	10	8435195821598	<b>37,63</b>

- Fabricado en latón cromado.
- Para lavabo y bidé.
- Sin válvula.

## TUBO ALARGO ABOCARDADO PARA SIFÓN BOTELLA



	Código	Medida	Caja	Código Barras	€ / Ud.
	<b>63526</b>	Ø 32 x 20 cm.	1	8435195823639	<b>3,22</b>
	<b>63528</b>	Ø 32 x 30 cm.	1	8435195823646	<b>3,64</b>
<b>Sin pestaña</b>	<b>63544</b>	Ø 32 x 20 cm.	1	8435195841589	<b>3,12</b>
<b>Sin pestaña</b>	<b>63545</b>	Ø 32 x 80 cm.	1	8435195826005	<b>8,40</b>

- Fabricado en latón cromado.

## TUBO SIFÓN EXTENSIBLE BLANCO



	Código	Medida	Caja	Código Barras	€ / Ud.
<b>Tuerca PVC</b>	<b>63510</b>	1 1/4" x 32 mm Ø	10	8435195809718	<b>1,59</b>
	<b>63511</b>	1 1/2" x 40 mm Ø	10	8435195809725	<b>1,94</b>

	Código	Medida	Caja	Código Barras	€ / Ud.
<b>Tuerca METAL</b>	<b>63512</b>	1 1/4" x 32 mm Ø	10	8435195809732	<b>1,76</b>
	<b>63513</b>	1 1/2" x 40 mm Ø	10	8435195809749	<b>1,96</b>

## TUBO SIFÓN EXTENSIBLE CROMADO



Código	Medida	Caja	Código Barras	€ / Ud.
<b>63518</b>	1 1/4" x 32 mm Ø	10	8435195809756	<b>6,61</b>
<b>63519</b>	1 1/2" x 40 mm Ø	10	8435195809763	<b>6,61</b>

## TUBO ALARGO EXTENSIBLE



Código	Medida	Caja	Código Barras	€ / Ud.
<b>63523</b>	Blanco Ø 32 - 40	10	8435195809770	<b>1,80</b>
<b>63524</b>	Cromo Ø 32 - 40	10	8435195809787	<b>5,44</b>

## SIFÓN "Y" CON VÁLVULA LAVABO / BIDÉ



Código	Medida	Caja	Código Barras	€ / Ud.
<b>25570</b>	1 1/2" x 40 mm. Ø	50	8435195832396	<b>4,16</b>

- Rejilla de Ø 70 mm. de acero inoxidable.
- Cadena de bolas en latón cromado.
- Incluye junta reductora de Ø 40 mm. a Ø 32 mm.

## SIFÓN BOTELLA CORTO EXTENSIBLE



Código	Medida	Caja	Código Barras	€ / Ud.
<b>25571</b>	1 1/4" x 40 mm. Ø	50	8435195832402	<b>5,28</b>

- Rejilla de Ø 70 mm. de acero inoxidable.
- Cadena de bolas en latón cromado.
- Incluye junta reductora de Ø 40 mm. a Ø 32 mm.

## SIFÓN BOTELLA EXTENSIBLE



Código	Medida	Caja	Código Barras	€ / Ud.
<b>25572</b>	1 1/2" x 40 mm. Ø	50	8435195832419	<b>4,85</b>

- Rejilla de Ø 70 mm. de acero inoxidable.
- Cadena de bolas en latón cromado.
- Incluye junta reductora de Ø 40 mm. a Ø 32 mm.

## SIFÓN BOTELLA EXTENSIBLE CON RACOR



Código	Medida	Caja	Código Barras	€ / Ud.
<b>25574</b>	1 1/2" x 40 mm. Ø	50	8435195832433	<b>2,68</b>

- Incluye junta reductora de Ø 40 mm. a Ø 32 mm.

## SIFÓN CURVO EXTENSIBLE



Código	Medida	Caja	Código Barras	€ / Ud.
<b>25573</b>	1 1/2" x 40 mm. Ø	50	8435195832426	<b>5,12</b>

- Rejilla de Ø 70 mm. de acero inoxidable.
- Cadena de bolas en latón cromado.
- Incluye junta reductora de Ø 40 mm. a Ø 32 mm.

## SIFÓN CURVO EXTENSIBLE CON RACOR



Código	Medida	Caja	Código Barras	€ / Ud.
<b>25575</b>	1 1/2" x 40 mm. Ø	50	8435195832440	<b>3,09</b>

- Incluye junta reductora de Ø 40 mm. a Ø 32 mm.

## SIFONES DESAGÜE



### SIFÓN DOBLE BOTELLA EXTENSIBLE DOBLE RACOR



Código	Medida	Caja	Código Barras	€ / Ud.
<b>25578</b>	1 1/2" x 40 mm. Ø	14	8435195832471	<b>6,37</b>

- Incluye junta reductora de Ø 40 mm. a Ø 32 mm.

### SIFÓN DOBLE CURVO EXTENSIBLE DOBLE RACOR



Código	Medida	Caja	Código Barras	€ / Ud.
<b>25577</b>	1 1/2" x 40 mm. Ø	10	8435195832464	<b>6,82</b>

- Incluye junta reductora de Ø 40 mm. a Ø 32 mm.

### SIFÓN DOBLE CURVO EXTENSIBLE ORIENTABLE DOBLE RACOR



Código	Medida	Caja	Código Barras	€ / Ud.
<b>25576</b>	1 1/2" x 40 mm. Ø	17	8435195832457	<b>8,16</b>

- Incluye junta reductora de Ø 40 mm. a Ø 32 mm.

### SIFÓN DE GOMA ABIERTO PARED



Código	Medida	Caja	Código Barras	€ / Ud.
<b>85025</b>	25 - 30 mm. Ø	30	8435195814996	<b>2,65</b>
<b>85026</b>	30 - 30 mm. Ø	30	8435195815009	<b>2,75</b>
<b>85027</b>	35 - 35 mm. Ø	30	8435195815016	<b>2,75</b>
<b>85033</b>	35 - 40 mm. Ø	10	8435195822717	<b>2,75</b>
<b>85034</b>	40 - 40 mm. Ø	10	8435195822724	<b>2,85</b>

### SIFÓN DE GOMA CERRADO SUELO



Código	Medida	Caja	Código Barras	€ / Ud.
<b>85028</b>	25 - 30 mm. Ø	30	8435195815023	<b>2,91</b>
<b>85029</b>	30 - 30 mm. Ø	30	8435195815030	<b>3,06</b>
<b>85030</b>	35 - 35 mm. Ø	30	8435195815047	<b>3,08</b>
<b>85035</b>	40 - 40 mm. Ø	10	8435195822731	<b>3,08</b>

### SIFÓN DE GOMA DOBLE FREGADERO



Código	Medida	Caja	Código Barras	€ / Ud.
<b>85031</b>	35 - 35 - 35 mm. Ø	10	8435195815054	<b>9,43</b>



# SIFONES DESAGÜE

Accesorios



## VÁLVULA DESAGÜE FREGADERO



Código	Medida	Caja	Código Barras	€ / Ud.
<b>25581</b>	1 1/2" x 85 mm. Ø	100	8435195832501	<b>3,23</b>

## VÁLVULA COMPLETA PARA SIFÓN DE GOMA



Código	Medida	Caja	Código Barras	€ / Ud.
<b>25518</b>	30 Ø	2	8435195817799	<b>3,21</b>
<b>63532</b>	35 Ø	2	8435195823615	<b>3,25</b>
<b>63533</b>	40 Ø	2	8435195823622	<b>3,50</b>

## VÁLVULA CON TAPÓN DE CAUCHO PARA SIFÓN BOTELLA

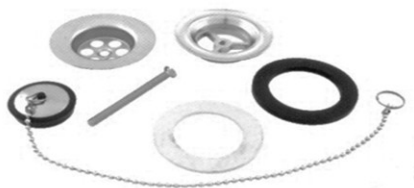

Código	Medida	Caja	Código Barras	€ / Ud.
<b>63522</b>	1 1/4"	1	8435195809824	<b>5,85</b>

## JUNTA CAUCHO CÓNICA PARA SIFÓN



Código	Medida	Caja	Código Barras	€ / Ud.
<b>25587</b>	1 1/4" x 32 mm. Ø	100	8435195835731	<b>0,38</b>
<b>25589</b>	1 1/2" x 40 mm. Ø	100	8435195835755	<b>0,38</b>

## CONJUNTO TUERCAS, GOMAS Y FLORÓN PARA SIFÓN BOTELLA



Código	Medida	Caja	Código Barras	€ / Ud.
<b>63527</b>	Única	1	8435195823653	<b>4,20</b>

## FLORÓN ABS



Código	Medida	Caja	Código Barras	€ / Ud.
<b>63546</b>	32 Ø Cromo	10	8435195826012	<b>0,48</b>
<b>63547</b>	40 Ø Cromo	10	8435195826029	<b>0,55</b>
<b>63548</b>	32 Ø Blanco	10	8435195826036	<b>0,23</b>
<b>63549</b>	40 Ø Blanco	10	8435195826043	<b>0,24</b>





## ENCHUFES DE GOMA

Enchufes de goma



90



## ACCESORIOS DE GOMA

### ENCHUFE DE GOMA A PRESIÓN INODORO



Código	Medida	Caja	Código Barras	€ / Ud.
<b>85021</b>	25 mm.	50	8435195814903	<b>0,97</b>
<b>85022</b>	30 mm.	50	8435195814910	<b>0,99</b>

### ENCHUFE DE GOMA A PRESIÓN INODORO VICTORIA



Código	Medida	Caja	Código Barras	€ / Ud.
<b>85020</b>	63 Ø Sin cuello	50	8435195814927	<b>1,29</b>
<b>85024</b>	63 Ø Con cuello	50	8435195814941	<b>1,41</b>

### ENCHUFE DE GOMA A PRESIÓN INODORO LUCERNA



Código	Medida	Caja	Código Barras	€ / Ud.
<b>85038</b>	53 Ø Sin cuello	50	8435195833737	<b>1,19</b>
<b>85023</b>	53 Ø Con cuello	50	8435195814935	<b>1,21</b>

### ENCHUFE DE LÁTEX A PRESIÓN INODORO



Código	Medida	Caja	Código Barras	€ / Ud.
<b>99347</b>	25 mm.	50	8435195814972	<b>1,04</b>
<b>99348</b>	30 mm.	50	8435195814989	<b>1,04</b>

### GOMA ALIMENTADOR LUCERNA - VICTORIA



Código	Medida	Caja	Código Barras	€ / Ud.
<b>98024</b>	28 Ø	50	8435195814965	<b>0,45</b>



### BOYA ROYAL CON VARILLA DE LATÓN



Código	Medida	Caja	Código Barras	€ / Ud.
<b>85032</b>	-	10	8435195815061	<b>1,74</b>



## CABEZALES UNIVERSALES, ACCESORIOS Y REPUESTOS

<b>Cabezales universales</b>		<b>92</b>
<b>Accesorios</b>		<b>94</b>
<b>Repuestos</b>		<b>95</b>

## CABEZALES UNIVERSALES



### CABEZAL UNIVERSAL VISTO VOLANTE 3 PUNTAS METÁLICO



Código	Medida	Caja	Código Barras	€ / Ud.
<b>40001</b>	16/150	12	8435195804232	<b>4,38</b>
<b>40002</b>	17/150	12	8435195804249	<b>4,38</b>
<b>40003</b>	18/150	12	8435195804256	<b>4,38</b>
<b>40004</b>	19/150	12	8435195804263	<b>4,38</b>
<b>40005</b>	20/125	12	8435195804270	<b>4,55</b>
<b>40006</b>	20/150	12	8435195804287	<b>4,55</b>
<b>40007</b>	21/125	12	8435195804294	<b>4,55</b>
<b>40008</b>	21/150	12	8435195804300	<b>4,55</b>
<b>40009</b>	22/150	12	8435195804317	<b>4,55</b>
<b>40010</b>	23/150	12	8435195836981	<b>5,18</b>
<b>40011</b>	3/8"	12	8435195804324	<b>4,38</b>
<b>40012</b>	1/2"	12	8435195804331	<b>4,55</b>
<b>40013</b>	5/8"	12	8435195804348	<b>4,69</b>
<b>40014</b>	3/4"	12	8435195804355	<b>5,53</b>
<b>40015</b>	26/150	12	8435195821048	<b>5,69</b>

### CABEZAL UNIV. EMPOTRAR VOLANTE 3 PUNTAS METÁLICO



Código	Medida	Caja	Código Barras	€ / Ud.
<b>41001</b>	16/150	12	8435195804362	<b>4,99</b>
<b>41002</b>	17/150	12	8435195804379	<b>4,99</b>
<b>41003</b>	18/150	12	8435195804386	<b>4,99</b>
<b>41004</b>	19/150	12	8435195804393	<b>4,99</b>
<b>41005</b>	20/125	12	8435195804409	<b>5,26</b>
<b>41006</b>	20/150	12	8435195804416	<b>5,26</b>
<b>41007</b>	21/125	12	8435195804423	<b>5,26</b>
<b>41008</b>	21/150	12	8435195804430	<b>5,26</b>
<b>41009</b>	22/150	12	8435195804447	<b>5,26</b>
<b>41010</b>	23/150	12	8435195836998	<b>5,88</b>
<b>41011</b>	3/8"	12	8435195804454	<b>4,99</b>
<b>41012</b>	1/2"	12	8435195804461	<b>5,26</b>
<b>41013</b>	5/8"	12	8435195804478	<b>5,54</b>
<b>41014</b>	3/4"	12	8435195804485	<b>5,84</b>
<b>41019</b>	26/150	12	8435195821055	<b>5,84</b>

## CABEZALES UNIVERSALES



### CABEZAL UNIVERSAL VISTO VOLANTE FACETADO METÁLICO



Código	Medida	Caja	Código Barras	€ / Ud.
<b>42001</b>	16/150	12	8435195804232	<b>7,58</b>
<b>42002</b>	17/150	12	8435195804249	<b>7,58</b>
<b>42003</b>	18/150	12	8435195804256	<b>7,58</b>
<b>42004</b>	19/150	12	8435195804263	<b>7,58</b>
<b>42005</b>	20/125	12	8435195804270	<b>7,68</b>
<b>42006</b>	20/150	12	8435195804287	<b>7,68</b>
<b>42007</b>	21/125	12	8435195804294	<b>7,68</b>
<b>42008</b>	21/150	12	8435195804300	<b>7,68</b>
<b>42009</b>	22/150	12	8435195804317	<b>7,68</b>
<b>42010</b>	23/150	12	8435195837032	<b>7,68</b>
<b>42011</b>	3/8"	12	8435195804324	<b>7,58</b>
<b>42012</b>	1/2"	12	8435195804331	<b>7,68</b>
<b>42013</b>	5/8"	12	8435195804348	<b>7,68</b>
<b>42014</b>	3/4"	12	8435195804355	<b>7,99</b>
<b>42015</b>	26/150	12	8435195821048	<b>7,99</b>

### CABEZAL UNIV. EMPOTRAR VOLANTE FACETADO METÁLICO



Código	Medida	Caja	Código Barras	€ / Ud.
<b>43001</b>	16/150	12	8435195804362	<b>8,16</b>
<b>43002</b>	17/150	12	8435195804379	<b>8,16</b>
<b>43003</b>	18/150	12	8435195804386	<b>8,16</b>
<b>43004</b>	19/150	12	8435195804393	<b>8,16</b>
<b>43005</b>	20/125	12	8435195804409	<b>8,26</b>
<b>43006</b>	20/150	12	8435195804416	<b>8,26</b>
<b>43007</b>	21/125	12	8435195804423	<b>8,26</b>
<b>43008</b>	21/150	12	8435195804430	<b>8,26</b>
<b>43009</b>	22/150	12	8435195804447	<b>8,26</b>
<b>43010</b>	23/150	12	8435195837049	<b>8,26</b>
<b>43011</b>	3/8"	12	8435195804454	<b>8,16</b>
<b>43012</b>	1/2"	12	8435195804461	<b>8,26</b>
<b>43013</b>	5/8"	12	8435195804478	<b>8,26</b>
<b>43014</b>	3/4"	12	8435195804485	<b>8,76</b>
<b>43019</b>	26/150	12	8435195821055	<b>8,76</b>

## CABEZALES UNIVERSALES



### RECAMBIO ALARGADERAS CABEZALES



Código	Medida	Caja	Código Barras	€ / Ud.
<b>86001</b>	28 mm.	12	8435195815207	<b>0,51</b>
<b>86002</b>	32 mm.	12	8435195815214	<b>0,58</b>
<b>86003</b>	40 mm.	12	8435195815221	<b>0,66</b>
<b>86004</b>	45 mm.	12	8435195815238	<b>0,99</b>
<b>86005</b>	50 mm.	12	8435195815245	<b>1,03</b>
<b>86006</b>	57 mm.	12	8435195815252	<b>1,12</b>
<b>86007</b>	67 mm.	12	8435195815269	<b>1,42</b>
<b>86008</b>	97 mm.	12	8435195815276	<b>2,62</b>

### PLACA MEDIDORA DE MONTURAS



Código	Medida	Caja	Código Barras	€ / Ud.
<b>41015</b>	Única	1	8435195804225	<b>37,86</b>

### EXPOSITOR CABEZALES



Código	Medida	Caja	Código Barras	€ / Ud.
<b>41017</b>	-	1	8435195822267	<b>139,12</b>

### EJE CABEZAL / GRUPILLA / JUNTA TÓRICA



Código	Descripción	Caja	Código Barras	€ / Ud.
<b>98083</b>	Eje visto	25	8435195832679	<b>0,64</b>
<b>98084</b>	Eje empotrar	25	8435195832686	<b>0,73</b>

Código	Descripción	Caja	Código Barras	€ / Ud.
<b>43030</b>	Grupilla	25	8435195832693	<b>0,12</b>
<b>83022</b>	Junta tórica	25	8435195832709	<b>0,029</b>

### MONTURA PRESIÓN CON CRUCETA



Código	Medida	Caja	Código Barras	€ / Ud.
<b>19062</b>	17 mm.	5	8435195832716	<b>7,22</b>
<b>19063</b>	18 mm.	5	8435195832723	<b>7,82</b>
<b>19064</b>	19 mm.	5	8435195832730	<b>7,82</b>
<b>19067</b>	22 mm.	5	8435195832747	<b>14,29</b>

### VÁLVULA TRIANÓN



Código	Medida	Caja	Código Barras	€ / Ud.
<b>99179</b>	16 mm.	1	8435195832754	<b>0,98</b>



## CABEZALES UNIVERSALES



### VOLANTE OCULTO ABS



Código	Medida	Caja	Código Barras	€ / Ud.
<b>19041</b>	Única	25	8435195800876	<b>0,49</b>

### VOLANTE OCULTO METÁLICO



Código	Medida	Caja	Código Barras	€ / Ud.
<b>19031</b>	Única	25	8435195800791	<b>1,28</b>

### VOLANTE FACETADO



Código	Descripción	Caja	Código Barras	€ / Ud.
<b>19034</b>	Única	25	8435195800807	<b>4,98</b>

- Incluye tapa e índices.

### VOLANTE 3 PUNTAS ABS



Código	Medida	Caja	Código Barras	€ / Ud.
<b>19035</b>	Única	25	8435195800814	<b>1,10</b>

### VOLANTE 3 PUNTAS METÁLICO



Código	Medida	Caja	Código Barras	€ / Ud.
<b>19038</b>	Única	25	8435195800845	<b>2,10</b>

### VOLANTE 3 PUNTAS METÁLICO CUADRADILLO



Código	Medida	Caja	Código Barras	€ / Ud.
<b>19053</b>	6,5 mm. Ø	25	8435195828221	<b>2,35</b>

## CABEZALES UNIVERSALES



### ALARGADERA CABEZAL



Código	Medida	Caja	Código Barras	€ / Ud.
<b>19030</b>	Única	25	8435195800784	<b>0,85</b>

### TORNILLO CABEZAL



Código	Medida	Caja	Código Barras	€ / Ud.
<b>98018</b>	M - 5 x 6	25	8435195822274	<b>0,04</b>

### ÍNDICE PARA VOLANTE ABS



Código	Descripción	Caja	Código Barras	€ / Ud.
<b>19036</b>	Azul	25	8435195800821	<b>0,035</b>
<b>19037</b>	Rojo	25	8435195800838	<b>0,035</b>

### ÍNDICE PARA VOLANTE METÁLICO



Código	Descripción	Caja	Código Barras	€ / Ud.
<b>19039</b>	Azul	25	8435195800852	<b>0,035</b>
<b>19040</b>	Rojo	25	8435195800869	<b>0,035</b>

### CASQUILLO CUBRE MONTURAS



Código	Descripción	Caja	Código Barras	€ / Ud.
<b>19042</b>	Única	25	8435195800883	<b>0,27</b>

### FLORÓN Y ANILLO CABEZAL



	Código	Medida	Caja	Código Barras	€ / Ud.
<b>Florón</b>	<b>19043</b>	Única	25	8435195800890	<b>0,55</b>
<b>Anillo</b>	<b>29034</b>	Única	25	8435195832761	<b>0,085</b>



## CONEXIONES FLEXIBLES

**Serie A**



**98**

**Termo "Serie Súper"**



**100**

**Batería de contador**



**102**

**Bomba de agua**



**103**



## CONEXIONES FLEXIBLES "SERIE A"

### APLICACIONES:

- INSTALACIONES DE AGUA SANITARIA
- LAVABOS
- BIDETS
- CONEXIONES DE GRIFERÍA

### CARACTERÍSTICAS TÉCNICAS:

- RACORES: LATÓN
- ROSCAS: BSP 3/8" - 1/2"
- CAMPANA: ACERO INOXIDABLE
- TUBO: TUBO DE CAUCHO E.P.D.M. ATÓXICO
- MALLA: TRENZADO 7 HILOS EN ACERO INOX. AISI 304
- NORMA: UNE 53.626



Ø INT.TUBO mm.	Ø EXT.TUBO mm.	TEMPERATURA MÁXIMA	TEMPERATURA CONTÍNUA	PRESIÓN TRABAJO	PRESIÓN ROTURA	RADIO CURVATURA	CAUDAL NOMINAL
9 mm.	13 mm.	100°C	70°C	25 Kg/cm <sup>2</sup>	100 Kg/cm <sup>2</sup>	40 mm.	29l./min.

### M 1/2" - H 3/8"

Código	Medida	Caja	Código Barras	€ / Ud.
55021	M 1/2" - H 3/8" x 15	10	8435195807226	1,69
55022	M 1/2" - H 3/8" x 20	10	8435195807233	1,78
55023	M 1/2" - H 3/8" x 25	10	8435195807240	1,97
55024	M 1/2" - H 3/8" x 30	10	8435195807257	1,99
55025	M 1/2" - H 3/8" x 35	10	8435195807264	2,10
55026	M 1/2" - H 3/8" x 40	10	8435195807271	2,20
55027	M 1/2" - H 3/8" x 45	10	8435195807288	2,29
55028	M 1/2" - H 3/8" x 50	10	8435195807295	2,39
55029	M 1/2" - H 3/8" x 60	10	8435195826135	2,92
55030	M 1/2" - H 3/8" x 100	10	8435195826142	3,79

### M 3/8" - H 1/2"

Código	Medida	Caja	Código Barras	€ / Ud.
55521	M 3/8" - H 1/2" x 15	10	8435195807301	1,69
55522	M 3/8" - H 1/2" x 20	10	8435195807318	1,75
55523	M 3/8" - H 1/2" x 25	10	8435195807325	1,89
55524	M 3/8" - H 1/2" x 30	10	8435195807332	2,09
55525	M 3/8" - H 1/2" x 35	10	8435195807349	2,10
55526	M 3/8" - H 1/2" x 40	10	8435195807356	2,20
55527	M 3/8" - H 1/2" x 45	10	8435195807363	2,52
55528	M 3/8" - H 1/2" x 50	10	8435195807370	2,68
55529	M 3/8" - H 1/2" x 60	10	8435195826159	2,92
55530	M 3/8" - H 1/2" x 100	10	8435195826166	3,79

### M 3/8" - H 3/8"

Código	Medida	Caja	Código Barras	€ / Ud.
56021	M 3/8" - H 3/8" x 15	10	8435195806823	1,62
56022	M 3/8" - H 3/8" x 20	10	8435195806830	1,65
56023	M 3/8" - H 3/8" x 25	10	8435195806847	1,77
56024	M 3/8" - H 3/8" x 30	10	8435195806854	1,89
56025	M 3/8" - H 3/8" x 35	10	8435195806861	1,93
56026	M 3/8" - H 3/8" x 40	10	8435195806878	1,99
56027	M 3/8" - H 3/8" x 45	10	8435195806885	2,18
56028	M 3/8" - H 3/8" x 50	10	8435195806892	2,24
56029	M 3/8" - H 3/8" x 60	10	8435195826173	2,93
56031	M 3/8" - H 3/8" x 70	10	8435195839838	3,76
56030	M 3/8" - H 3/8" x 100	10	8435195826180	3,86

## CONEXIONES FLEXIBLES "SERIE A"



### H 1/2" - H 1/2"

Código	Medida	Caja	Código Barras	€ / Ud.
52521	H 1/2" - H 1/2" x 15	10	8435195806984	1,72
52522	H 1/2" - H 1/2" x 20	10	8435195806991	1,79
52523	H 1/2" - H 1/2" x 25	10	8435195807004	1,89
52524	H 1/2" - H 1/2" x 30	10	8435195807011	1,99
52525	H 1/2" - H 1/2" x 35	10	8435195807028	2,10
52526	H 1/2" - H 1/2" x 40	10	8435195807035	2,23
52527	H 1/2" - H 1/2" x 45	10	8435195807042	2,29
52528	H 1/2" - H 1/2" x 50	10	8435195807059	2,39
52529	H 1/2" - H 1/2" x 60	10	8435195826050	2,92
52530	H 1/2" - H 1/2" x 100	10	8435195826067	3,79
52533	H 1/2" - H 1/2" x 150	10	8435195839630	7,28
52532	H 1/2" - H 1/2" x 200	10	8435195839623	12,16

### H 3/8" - H 3/8"

Código	Medida	Caja	Código Barras	€ / Ud.
53020	H 3/8" - H 3/8" x 10	10	8435195839708	1,95
53021	H 3/8" - H 3/8" x 15	10	8435195806908	1,60
53022	H 3/8" - H 3/8" x 20	10	8435195806915	1,65
53023	H 3/8" - H 3/8" x 25	10	8435195806922	1,75
53024	H 3/8" - H 3/8" x 30	10	8435195806939	1,89
53025	H 3/8" - H 3/8" x 35	10	8435195806946	1,91
53026	H 3/8" - H 3/8" x 40	10	8435195806953	2,04
53028	H 3/8" - H 3/8" x 50	10	8435195806977	2,21
53029	H 3/8" - H 3/8" x 60	10	8435195826074	2,93
53031	H 3/8" - H 3/8" x 70	10	8435195839715	3,70
53030	H 3/8" - H 3/8" x 100	10	8435195826081	3,86
53011	H 3/8" - H 3/8" x 150	10	8435195839692	6,82
53010	H 3/8" - H 3/8" x 200	10	8435195839685	9,04

### H 1/2" - H 3/8"

Código	Medida	Caja	Código Barras	€ / Ud.
53521	H 1/2" - H 3/8" x 15	10	8435195807066	1,67
53522	H 1/2" - H 3/8" x 20	10	8435195807073	1,78
53523	H 1/2" - H 3/8" x 25	10	8435195807080	1,89
53524	H 1/2" - H 3/8" x 30	10	8435195807097	1,99
53525	H 1/2" - H 3/8" x 35	10	8435195807103	2,23
53526	H 1/2" - H 3/8" x 40	10	8435195807110	2,25
53527	H 1/2" - H 3/8" x 45	10	8435195807127	2,29
53528	H 1/2" - H 3/8" x 50	10	8435195807134	2,39
53529	H 1/2" - H 3/8" x 60	10	8435195826098	2,92
53530	H 1/2" - H 3/8" x 100	10	8435195826104	3,79

### M 1/2" - H 1/2"

Código	Medida	Caja	Código Barras	€ / Ud.
54021	M 1/2" - H 1/2" x 15	10	8435195807141	1,69
54022	M 1/2" - H 1/2" x 20	10	8435195807158	1,79
54023	M 1/2" - H 1/2" x 25	10	8435195807165	1,89
54024	M 1/2" - H 1/2" x 30	10	8435195807172	1,99
54025	M 1/2" - H 1/2" x 35	10	8435195807189	2,23
54026	M 1/2" - H 1/2" x 40	10	8435195807196	2,25
54027	M 1/2" - H 1/2" x 45	10	8435195807102	2,29
54028	M 1/2" - H 1/2" x 50	10	8435195807119	2,39
54029	M 1/2" - H 1/2" x 60	10	8435195826111	2,92
54031	M 1/2" - H 1/2" x 70	10	8435195839814	3,72
54030	M 1/2" - H 1/2" x 100	10	8435195826128	3,79
54009	M 1/2" - H 1/2" x 150	10	8435195839753	7,42
54008	M 1/2" - H 1/2" x 200	10	8435195839746	9,40

**Nota: Se pueden fabricar conexiones sobre pedido, en cualquier medida y largo.**

## CONEXIONES FLEXIBLES TERMO "SERIE SÚPER"



### APLICACIONES:

- INSTALACIONES DE AGUA SANITARIA
- CALENTADORES
- TERMOS
- ACUMULADORES
- PLACAS SOLARES
- AIRE ACONDICIONADO



### CARACTERÍSTICAS TÉCNICAS:

- RACORES: LATÓN
- ROSCAS: BSP 1/2" - 3/4"
- CAMPANA: ACERO INOXIDABLE
- TUBO: TUBO DE CAUCHO E.P.D.M. ATÓXICO
- MALLA: TRENZADO 7 HILOS EN ACERO INOX. AISI 304

Ø INT.TUBO mm.	Ø EXT.TUBO mm.	TEMPERATURA MÁXIMA	TEMPERATURA CONTÍNUA	PRESIÓN TRABAJO	PRESIÓN ROTURA	RADIO CURVATURA	CAUDAL NOMINAL
13 mm.	19 mm.	100°C	70°C	20 Kg/cm <sup>2</sup>	80 Kg/cm <sup>2</sup>	50 mm.	75l./min.

### M 1/2" - H 1/2"

Código	Medida	Caja	Código Barras	€ / Ud.
56511	M 1/2" - H 1/2" x 15	10	8435195807387	3,39
56512	M 1/2" - H 1/2" x 20	10	8435195807394	3,62
56513	M 1/2" - H 1/2" x 25	10	8435195807400	3,68
56514	M 1/2" - H 1/2" x 30	10	8435195807417	3,89
56515	M 1/2" - H 1/2" x 35	10	8435195807424	4,12
56516	M 1/2" - H 1/2" x 40	10	8435195807431	4,16
56517	M 1/2" - H 1/2" x 45	10	8435195807448	4,35
56518	M 1/2" - H 1/2" x 50	10	8435195807455	4,68
56519	M 1/2" - H 1/2" x 60	10	8435195826197	7,28
56510	M 1/2" - H 1/2" x 80	10	8435195840346	7,49
56520	M 1/2" - H 1/2" x 100	10	8435195826203	8,81

### H 1/2" - H 1/2"

Código	Medida	Caja	Código Barras	€ / Ud.
56521	H 1/2" - H 1/2" x 15	10	8435195807462	3,39
56522	H 1/2" - H 1/2" x 20	10	8435195807479	3,62
56523	H 1/2" - H 1/2" x 25	10	8435195807486	3,68
56524	H 1/2" - H 1/2" x 30	10	8435195807493	3,84
56525	H 1/2" - H 1/2" x 35	10	8435195807509	3,99
56526	H 1/2" - H 1/2" x 40	10	8435195807516	4,19
56527	H 1/2" - H 1/2" x 45	10	8435195807523	4,49
56528	H 1/2" - H 1/2" x 50	10	8435195807530	4,68
56529	H 1/2" - H 1/2" x 60	10	8435195826210	7,28
56530	H 1/2" - H 1/2" x 100	10	8435195826227	8,81

### M 1/2" - H 3/4"

Código	Medida	Caja	Código Barras	€ / Ud.
56531	M 1/2" - H 3/4" x 15	10	8435195807547	3,76
56532	M 1/2" - H 3/4" x 20	10	8435195807554	3,99
56533	M 1/2" - H 3/4" x 25	10	8435195807561	4,16
56534	M 1/2" - H 3/4" x 30	10	8435195807578	4,29
56535	M 1/2" - H 3/4" x 35	10	8435195807585	4,48
56536	M 1/2" - H 3/4" x 40	10	8435195807592	4,64
56537	M 1/2" - H 3/4" x 45	10	8435195807608	4,80
56538	M 1/2" - H 3/4" x 50	10	8435195807615	4,99
56539	M 1/2" - H 3/4" x 60	10	8435195826234	7,80
56540	M 1/2" - H 3/4" x 100	10	8435195826241	8,95

## CONEXIONES FLEXIBLES TERMO "SERIE SÚPER"



### H 1/2" - H 3/4"

Código	Medida	Caja	Código Barras	€ / Ud.
56541	H 1/2" - H 3/4" x 15	10	8435195807622	<b>3,76</b>
56542	H 1/2" - H 3/4" x 20	10	8435195807639	<b>3,99</b>
56543	H 1/2" - H 3/4" x 25	10	8435195807646	<b>4,16</b>
56544	H 1/2" - H 3/4" x 30	10	8435195807653	<b>4,29</b>
56545	H 1/2" - H 3/4" x 35	10	8435195807660	<b>4,48</b>
56546	H 1/2" - H 3/4" x 40	10	8435195807677	<b>4,64</b>
56547	H 1/2" - H 3/4" x 45	10	8435195807684	<b>4,80</b>
56548	H 1/2" - H 3/4" x 50	10	8435195807691	<b>4,99</b>
56549	H 1/2" - H 3/4" x 60	10	8435195826258	<b>7,80</b>
56550	H 1/2" - H 3/4" x 100	10	8435195826265	<b>8,95</b>

### M 3/4" - H 3/4"

Código	Medida	Caja	Código Barras	€ / Ud.
56551	M 3/4" - H 3/4" x 15	10	8435195807707	<b>3,76</b>
56552	M 3/4" - H 3/4" x 20	10	8435195807714	<b>3,99</b>
56553	M 3/4" - H 3/4" x 25	10	8435195807721	<b>4,16</b>
56554	M 3/4" - H 3/4" x 30	10	8435195807738	<b>4,39</b>
56555	M 3/4" - H 3/4" x 35	10	8435195807745	<b>4,48</b>
56556	M 3/4" - H 3/4" x 40	10	8435195807752	<b>4,79</b>
56557	M 3/4" - H 3/4" x 45	10	8435195807769	<b>4,89</b>
56558	M 3/4" - H 3/4" x 50	10	8435195807776	<b>5,24</b>
56559	M 3/4" - H 3/4" x 60	10	8435195826272	<b>7,80</b>
56560	M 3/4" - H 3/4" x 100	10	8435195826289	<b>8,95</b>

### M 3/4" - H 1/2"

Código	Medida	Caja	Código Barras	€ / Ud.
56561	M 3/4" - H 1/2" x 15	10	8435195807783	<b>3,76</b>
56562	M 3/4" - H 1/2" x 20	10	8435195807790	<b>3,99</b>
56563	M 3/4" - H 1/2" x 25	10	8435195807806	<b>4,16</b>
56564	M 3/4" - H 1/2" x 30	10	8435195807813	<b>4,29</b>
56565	M 3/4" - H 1/2" x 35	10	8435195807820	<b>4,48</b>
56566	M 3/4" - H 1/2" x 40	10	8435195807837	<b>4,74</b>
56567	M 3/4" - H 1/2" x 45	10	8435195807844	<b>4,80</b>
56568	M 3/4" - H 1/2" x 50	10	8435195807851	<b>4,99</b>
56569	M 3/4" - H 1/2" x 60	10	8435195826296	<b>7,80</b>
56570	M 3/4" - H 1/2" x 100	10	8435195826302	<b>8,95</b>

### H 3/4" - H 3/4"

Código	Medida	Caja	Código Barras	€ / Ud.
56571	H 3/4" - H 3/4" x 15	10	8435195807868	<b>3,76</b>
56572	H 3/4" - H 3/4" x 20	10	8435195807875	<b>3,99</b>
56573	H 3/4" - H 3/4" x 25	10	8435195807882	<b>4,16</b>
56574	H 3/4" - H 3/4" x 30	10	8435195807899	<b>4,32</b>
56575	H 3/4" - H 3/4" x 35	10	8435195807905	<b>4,54</b>
56576	H 3/4" - H 3/4" x 40	10	8435195807912	<b>4,84</b>
56577	H 3/4" - H 3/4" x 45	10	8435195807929	<b>4,95</b>
56578	H 3/4" - H 3/4" x 50	10	8435195807936	<b>5,21</b>
56579	H 3/4" - H 3/4" x 60	10	8435195826319	<b>7,80</b>
56580	H 3/4" - H 3/4" x 100	10	8435195826326	<b>8,95</b>

**Nota: Se pueden fabricar conexiones sobre pedido, en cualquier medida y largo.**

## CONEXIONES FLEXIBLES BATERÍAS CONTADOR



### APLICACIONES:

- BATERÍAS DE CONTADOR
- ACOMETIDAS
- CALEFACCIÓN
- AIRE ACONDICIONADO

### CARACTERÍSTICAS TÉCNICAS:

- RACORES: LATÓN
- ROSCAS: BSP 3/4" - 1" - 1 1/4"
- CAMPANA: ACERO INOXIDABLE
- TUBO: TUBO DE CAUCHO E.P.D.M. ATÓXICO
- MALLA: TRENZADO EN ACERO INOX. AISI 304



CONEXIÓN	Ø INT.TUBO mm.	Ø EXT.TUBO mm.	TEMPERATURA MÁXIMA	TEMPERATURA CONTÍNUA	PRESIÓN TRABAJO	PRESIÓN ROTURA	RADIO CURVATURA	CAUDAL NOMINAL
3/4"	19 mm.	28 mm.	90°C	70°C	15 Kg/cm <sup>2</sup>	60 Kg/cm <sup>2</sup>	80 mm.	150 l./min.
1"	25 mm.	35 mm.	90°C	70°C	10 Kg/cm <sup>2</sup>	40 Kg/cm <sup>2</sup>	130 mm.	250 l./min.
1 1/4"	30 mm.	40 mm.	90°C	70°C	10 Kg/cm <sup>2</sup>	40 Kg/cm <sup>2</sup>	200 mm.	400l./min.

### M 3/4" - H 3/4"

Código	Medida	Caja	Código Barras	€/ Ud.
<b>56102</b>	M 3/4" - H 3/4" x 30	1	8435195823431	<b>11,92</b>
<b>56104</b>	M 3/4" - H 3/4" x 40	1	8435195823448	<b>12,08</b>
<b>56106</b>	M 3/4" - H 3/4" x 50	1	8435195823455	<b>12,65</b>
<b>56108</b>	M 3/4" - H 3/4" x 60	1	8435195823462	<b>13,95</b>
<b>56110</b>	M 3/4" - H 3/4" x 80	1	8435195823479	<b>18,01</b>
<b>56112</b>	M 3/4" - H 3/4" x 100	1	8435195823486	<b>20,41</b>

### M 1" - H 1"

Código	Medida	Caja	Código Barras	€/ Ud.
<b>56117</b>	M 1" - H 1" x 30	1	8435195823493	<b>18,12</b>
<b>56119</b>	M 1" - H 1" x 40	1	8435195823509	<b>18,88</b>
<b>56121</b>	M 1" - H 1" x 50	1	8435195823516	<b>20,55</b>
<b>56123</b>	M 1" - H 1" x 60	1	8435195823523	<b>21,19</b>
<b>56125</b>	M 1" - H 1" x 80	1	8435195823530	<b>24,81</b>
<b>56127</b>	M 1" - H 1" x 100	1	8435195823547	<b>28,80</b>

### M 1 1/4" - H 1 1/4"

Código	Medida	Caja	Código Barras	€/ Ud.
<b>56131</b>	M 1 1/4" - H 1 1/4" x 30	1	8435195823554	<b>28,24</b>
<b>56133</b>	M 1 1/4" - H 1 1/4" x 40	1	8435195823561	<b>31,12</b>
<b>56135</b>	M 1 1/4" - H 1 1/4" x 50	1	8435195823578	<b>34,05</b>
<b>56137</b>	M 1 1/4" - H 1 1/4" x 60	1	8435195823585	<b>38,43</b>
<b>56139</b>	M 1 1/4" - H 1 1/4" x 80	1	8435195823592	<b>46,96</b>
<b>56141</b>	M 1 1/4" - H 1 1/4" x 100	1	8435195823608	<b>53,44</b>

**Nota: Se pueden fabricar conexiones sobre pedido, en cualquier medida y largo.**



## CONEXIONES FLEXIBLES PARA BOMBA DE AGUA



### APLICACIONES:

- BOMBAS DE AGUA
- ACOMETIDAS INSTALACIONES INDUSTRIALES

### CARACTERÍSTICAS TÉCNICAS:

- RACORES: LATÓN
- ROSCAS: BSP 3/4" - 1" - 1 1/4" - 1 1/2" - 2"
- CAMPANA: ACERO GALVANIZADO
- TUBO: TUBO DE CAUCHO E.P.D.M. ATÓXICO
- MALLA: TRENZADO EN ACERO GALVANIZADO



**Apartir de 1" los tubos incorporan un refuerzo de trenzado intermedio.**

CONEXIÓN	Ø INT.TUBO mm.	Ø EXT.TUBO mm.	TEMPERATURA MÁXIMA	TEMPERATURA CONTÍNUA	PRESIÓN TRABAJO	PRESIÓN ROTURA	RADIO CURVATURA	CAUDAL NOMINAL
3/4"	19 mm.	28 mm.	90°C	70°C	15 Kg/cm <sup>2</sup>	60 Kg/cm <sup>2</sup>	80 mm.	150 l./min.
1"	25 mm.	35 mm.	90°C	70°C	12 Kg/cm <sup>2</sup>	40 Kg/cm <sup>2</sup>	130 mm.	250 l./min.
1 1/4"	30 mm.	40 mm.	90°C	70°C	10 Kg/cm <sup>2</sup>	30 Kg/cm <sup>2</sup>	200 mm.	400l./min.
1 1/2"	40 mm.	52 mm.	90°C	70°C	8 Kg/cm <sup>2</sup>	25 Kg/cm <sup>2</sup>	230 mm.	750 l./min.
2"	50 mm.	62 mm.	90°C	70°C	7 Kg/cm <sup>2</sup>	20 Kg/cm <sup>2</sup>	300 mm.	1250 l./min.

### M 3/4" - H 3/4"

Código	Medida	Caja	Código Barras	€ / Ud.
<b>50104</b>	M 3/4" - H 3/4" x 40	1	8435195826333	<b>12,40</b>
<b>50106</b>	M 3/4" - H 3/4" x 50	1	8435195826340	<b>12,95</b>
<b>50108</b>	M 3/4" - H 3/4" x 60	1	8435195826357	<b>14,68</b>

### H 3/4" - H 3/4"

Código	Medida	Caja	Código Barras	€ / Ud.
<b>50116</b>	H 3/4" - H 3/4" x 40	1	8435195826364	<b>11,60</b>
<b>50118</b>	H 3/4" - H 3/4" x 50	1	8435195826371	<b>12,92</b>
<b>50120</b>	H 3/4" - H 3/4" x 60	1	8435195826388	<b>14,08</b>

### M 1" - H 1"

Código	Medida	Caja	Código Barras	€ / Ud.
<b>50126</b>	M 1" - H 1" x 40	1	8435195826395	<b>20,18</b>
<b>50128</b>	M 1" - H 1" x 50	1	8435195826401	<b>21,64</b>
<b>50130</b>	M 1" - H 1" x 60	1	8435195826418	<b>22,95</b>

### H 1" - H 1"

Código	Medida	Caja	Código Barras	€ / Ud.
<b>50137</b>	H 1" - H 1" x 40	1	8435195826425	<b>19,92</b>
<b>50139</b>	H 1" - H 1" x 50	1	8435195826432	<b>21,64</b>
<b>50140</b>	H 1" - H 1" x 60	1	8435195826449	<b>22,95</b>

### M 1 1/4" - H 1 1/4"

Código	Medida	Caja	Código Barras	€ / Ud.
<b>50148</b>	M 1 1/4" - H 1 1/4" x 40	1	8435195826456	<b>32,68</b>
<b>50150</b>	M 1 1/4" - H 1 1/4" x 50	1	8435195826463	<b>35,70</b>
<b>50151</b>	M 1 1/4" - H 1 1/4" x 60	1	8435195826470	<b>40,53</b>

## CONEXIONES FLEXIBLES PARA BOMBA DE AGUA



### H 1 1/4" - H 1 1/4"

Código	Medida	Caja	Código Barras	€ / Ud.
<b>50163</b>	H 1 1/4" - H 1 1/4" x 40	1	8435195826487	<b>45,99</b>
<b>50165</b>	H 1 1/4" - H 1 1/4" x 50	1	8435195826494	<b>50,54</b>
<b>50167</b>	H 1 1/4" - H 1 1/4" x 60	1	8435195826500	<b>55,05</b>

### M 1 1/2" - H 1 1/2"

Código	Medida	Caja	Código Barras	€ / Ud.
<b>50174</b>	M 1 1/2" - H 1 1/2" x 40	1	8435195826517	<b>54,40</b>
<b>50176</b>	M 1 1/2" - H 1 1/2" x 50	1	8435195826524	<b>59,14</b>
<b>50178</b>	M 1 1/2" - H 1 1/2" x 60	1	8435195826531	<b>63,90</b>

### H 1 1/2" - H 1 1/2"

Código	Medida	Caja	Código Barras	€ / Ud.
<b>50188</b>	H 1 1/2" - H 1 1/2" x 40	1	8435195826548	<b>56,58</b>
<b>50190</b>	H 1 1/2" - H 1 1/2" x 50	1	8435195826555	<b>61,28</b>
<b>50192</b>	H 1 1/2" - H 1 1/2" x 60	1	8435195826562	<b>65,97</b>

### M 2" - H 2"

Código	Medida	Caja	Código Barras	€ / Ud.
<b>50203</b>	M 2" - H 2" x 40	1	8435195826579	<b>79,68</b>
<b>50205</b>	M 2" - H 2" x 50	1	8435195826586	<b>78,37</b>
<b>50207</b>	M 2" - H 2" x 60	1	8435195826593	<b>83,80</b>

### H 2" - H 2"

Código	Medida	Caja	Código Barras	€ / Ud.
<b>50218</b>	H 2" - H 2" x 40	1	8435195826609	<b>73,69</b>
<b>50220</b>	H 2" - H 2" x 50	1	8435195826616	<b>79,14</b>
<b>50222</b>	H 2" - H 2" x 60	1	8435195826623	<b>84,58</b>

**Nota: Se pueden fabricar conexiones sobre pedido, en cualquier medida y largo.**



## CONEXIONES PARA LAVADORA

Conexiones lavadora / lavavajillas



106



## CONEXIONES PARA LAVADORA

### TOMA ENTRADA LAVADORA / LAVAVAJILLAS tuerca nylon



Código	Medida	Caja	Código Barras	€ / Ud.
<b>52006</b>	1,5 m.	10	8435195806663	<b>2,68</b>
<b>52007</b>	2 m.	10	8435195806670	<b>3,08</b>
<b>52014</b>	3 m.	10	8435195806687	<b>4,92</b>

### TOMA ENTRADA LAVADORA / LAVAVAJILLAS tuerca latón



Código	Medida	Caja	Código Barras	€ / Ud.
<b>52008</b>	1,5 m.	10	8435195806694	<b>4,73</b>
<b>52009</b>	2 m.	10	8435195806700	<b>5,21</b>
<b>52013</b>	3 m.	10	8435195806717	<b>6,28</b>

### SALIDA DE LAVADORA / LAVAVAJILLAS



Código	Medida	Caja	Código Barras	€ / Ud.
<b>52010</b>	1,5 m.	10	8435195806724	<b>2,04</b>
<b>52012</b>	2 m.	10	8435195806748	<b>2,22</b>
<b>52015</b>	3 m.	10	8435195806755	<b>3,70</b>

### SALIDA DE LAVADORA / LAVAVAJILLAS EXTENSIBLE



Código	Medida	Caja	Código Barras	€ / Ud.
<b>52017</b>	0,60 a 1,60 m.	10	8435195821307	<b>2,86</b>

### CURVA SALIDA LAVADORA / LAVAVAJILLAS



Código	Medida	Caja	Código Barras	€ / Ud.
<b>52011</b>	única	10	8435195806731	<b>0,21</b>



## VÁLVULAS ESFERA EMPOTRAR Y ACCESORIOS

**Válvulas esfera empotrar**



**108**

**Accesorios**



**109**



## VÁLVULAS ESFERA EMPOTRAR

### VÁLVULA ESFERA SERIE BOSTON SOLDAR



Código	Medida	Caja	Código Barras	€ / Ud.
<b>27015</b>	15 x 15	10	8435195802573	<b>6,98</b>
<b>27018</b>	18 x 18	10	8435195802580	<b>7,26</b>
<b>27022</b>	22 x 22	10	8435195802597	<b>7,89</b>
<b>27028</b>	28 x 28	10	8435195802603	<b>12,62</b>

- Válvula de esfera empotrar SOLDAR.
- PN 16 Paso total.
- Fabricada en latón UNE-EN 12165.
- Extremos para soldar H-H.
- ISO 228/1. Temperatura máxima 150°C.

### VÁLVULA ESFERA SERIE BOSTON ROSCAR



Código	Medida	Caja	Código Barras	€ / Ud.
<b>27503</b>	1/2" X 1/2"	10	8435195802610	<b>6,34</b>
<b>27504</b>	3/4" X 3/4"	10	8435195802627	<b>7,85</b>
<b>27505</b>	1" X 1"	10	8435195802634	<b>12,62</b>

- Válvula de esfera empotrar ROSCAR.
- PN 16 Paso total.
- Fabricada en latón UNE-EN 12165.
- Extremos roscados H-H.
- ISO 228/1. Temperatura máxima 150°C.

### VÁLVULA ESFERA SERIE BOSTON MULTICAPA



Código	Medida	Caja	Código Barras	€ / Ud.
<b>27616</b>	Ø 16	10	8435195820157	<b>7,43</b>
<b>27620</b>	Ø 20	10	8435195820164	<b>8,07</b>
<b>27625</b>	Ø 25	10	8435195820171	<b>8,99</b>
<b>27632</b>	Ø 32	10	8435195820188	<b>13,10</b>

- Válvula empotrar tubería PEX y MULTICAPA con casquillos.
- PN 25 Paso total.
- Fabricada en latón cromado según UNE-EN 12165.
- Juntas E.P.D.M.
- Temperatura máxima 110°C.



## VÁLVULAS ESFERA EMPOTRAR

Accesorios

### MANDO Y FLORÓN METÁLICO "MODELO MERCURI"



Código	Medida	Caja	Código Barras	€ / Ud.
<b>28001</b>	Única	50	8435195802658	<b>3,56</b>

### MANDO Y FLORÓN PALANCA METÁLICO "MODELO ONDA"



Código	Medida	Caja	Código Barras	€ / Ud.
<b>29003</b>	Única	50	8435195802665	<b>3,23</b>

### MANDO Y FLORÓN OCULTO METÁLICO "MODELO POLARE"



Código	Medida	Caja	Código Barras	€ / Ud.
<b>29504</b>	Única	50	8435195802672	<b>2,95</b>
<b>29506</b>	Con cuadradillo	50	8435195826647	<b>2,45</b>

- Compatible con válvulas empotrar Uponor y multicapa.

### ALARGADERA VÁLVULA EMPOTRAR SERIE BOSTON



Código	Medida	Caja	Código Barras	€ / Ud.
<b>19032</b>	Única	25	8435195802689	<b>1,21</b>



- Incluye el tornillo.







## VÁLVULAS DE CONTROL

<b>Soldar</b>		<b>112</b>
<b>Roscar</b>		<b>113</b>
<b>Recambios</b>		<b>114</b>

## VÁLVULAS DE CONTROL SOLDAR



### VÁLVULA CONTROL SOLDAR VOLANTE 3 PUNTAS ABS



	Código	Medida	Caja	Código Barras	€ / Ud.
<b>Cuello largo</b>	<b>15015</b>	15 x 15	72	8435195800180	<b>5,98</b>
	<b>15018</b>	18 x 18	72	8435195800197	<b>6,39</b>
	<b>15022</b>	22 x 22	72	8435195800203	<b>6,98</b>
	<b>15028</b>	28 x 28	36	8435195800210	<b>12,26</b>

	Código	Medida	Caja	Código Barras	€ / Ud.
<b>Cuello corto</b>	<b>15122</b>	22 x 22	72	8435195800241	<b>6,98</b>

### VÁLVULA CONTROL SOLDAR VOLANTE 3 PUNTAS METÁLICO



	Código	Medida	Caja	Código Barras	€ / Ud.
<b>Cuello largo</b>	<b>15515</b>	15 x 15	72	8435195800258	<b>6,79</b>
	<b>15518</b>	18 x 18	72	8435195800265	<b>7,14</b>
	<b>15522</b>	22 x 22	72	8435195800272	<b>7,55</b>
	<b>15528</b>	28 x 28	36	8435195800289	<b>12,79</b>

	Código	Medida	Caja	Código Barras	€ / Ud.
<b>Cuello corto</b>	<b>15622</b>	22 x 22	72	8435195800319	<b>7,55</b>

### VÁLVULA CONTROL SOLDAR VOLANTE FACETADO METÁLICO



	Código	Medida	Caja	Código Barras	€ / Ud.
<b>Cuello largo</b>	<b>16015</b>	15 x 15	72	8435195800326	<b>9,65</b>
	<b>16018</b>	18 x 18	72	8435195800333	<b>10,09</b>
	<b>16022</b>	22 x 22	72	8435195800340	<b>10,98</b>
	<b>16028</b>	28 x 28	36	8435195800357	<b>15,27</b>

	Código	Medida	Caja	Código Barras	€ / Ud.
<b>Cuello corto</b>	<b>16122</b>	22 x 22	72	8435195800388	<b>10,98</b>

### VÁLVULA CONTROL SOLDAR VOLANTE OCULTO ABS



	Código	Medida	Caja	Código Barras	€ / Ud.
<b>Cuello largo</b>	<b>16515</b>	15 x 15	72	8435195800395	<b>5,46</b>
	<b>16518</b>	18 x 18	72	8435195800401	<b>5,82</b>
	<b>16522</b>	22 x 22	72	8435195800418	<b>6,22</b>
	<b>16528</b>	28 x 28	36	8435195800425	<b>11,66</b>

	Código	Medida	Caja	Código Barras	€ / Ud.
<b>Cuello corto</b>	<b>16622</b>	22 x 22	72	8435195800456	<b>6,22</b>

### VÁLVULA CONTROL SOLDAR VOLANTE OCULTO METÁLICO



	Código	Medida	Caja	Código Barras	€ / Ud.
<b>Cuello largo</b>	<b>16715</b>	15 x 15	72	8435195800463	<b>6,14</b>
	<b>16718</b>	18 x 18	72	8435195800470	<b>6,32</b>
	<b>16722</b>	22 x 22	72	8435195800487	<b>6,80</b>
	<b>16728</b>	28 x 28	36	8435195800494	<b>12,47</b>

	Código	Medida	Caja	Código Barras	€ / Ud.
<b>Cuello corto</b>	<b>16822</b>	22 x 22	72	8435195800524	<b>6,80</b>

## VÁLVULAS DE CONTROL ROSCAR



### VÁLVULA CONTROL ROSCAR VOLANTE 3 PUNTAS ABS



Código	Medida	Caja	Código Barras	€ / Ud.
<b>17002</b>	H 1/2" x H 1/2"	36	8435195800531	<b>7,32</b>
<b>17004</b>	H 3/4" x H 3/4"	36	8435195800548	<b>9,35</b>

### VÁLVULA CONTROL ROSCAR VOLANTE 3 PUNTAS METÁLICO



Código	Medida	Caja	Código Barras	€ / Ud.
<b>17502</b>	H 1/2" x H 1/2"	36	8435195800555	<b>7,98</b>
<b>17504</b>	H 3/4" x H 3/4"	36	8435195800562	<b>9,97</b>

### VÁLVULA CONTROL ROSCAR VOLANTE FACETADO METÁLICO



Código	Medida	Caja	Código Barras	€ / Ud.
<b>18002</b>	H 1/2" x H 1/2"	36	8435195800579	<b>11,99</b>
<b>18004</b>	H 3/4" x H 3/4"	36	8435195800586	<b>13,94</b>

### VÁLVULA CONTROL ROSCAR VOLANTE OCULTO ABS



Código	Medida	Caja	Código Barras	€ / Ud.
<b>18502</b>	H 1/2" x H 1/2"	36	8435195800593	<b>6,94</b>
<b>18504</b>	H 3/4" x H 3/4"	36	8435195800609	<b>8,61</b>

### VÁLVULA DUCHA PISCINAS VOLANTE FACETADO METÁLICO



	Código	Medida	Caja	Código Barras	€ / Ud.
<b>Cuello corto</b>	<b>18507</b>	H 1/2" x H 1/2"	36	8435195800623	<b>11,34</b>

### VÁLVULA DUCHA PISCINAS VOLANTE OCULTO METÁLICO



	Código	Medida	Caja	Código Barras	€ / Ud.
<b>Cuello largo</b>	<b>18508</b>	H 1/2" x H 1/2"	36	8435195800630	<b>8,04</b>
<b>Cuello corto</b>	<b>18511</b>	H 1/2" x H 1/2"	36	8435195800647	<b>7,65</b>

# RECAMBIOS VÁLVULAS CONTROL



## CUERPO VÁLVULA CONTROL



	Código	Medida	Caja	Código Barras	€ / Ud.
<b>Cuello largo</b>	<b>18615</b>	15 x 15 Ø soldar	10	8435195800654	<b>2,44</b>
	<b>18618</b>	18 x 18 Ø soldar	10	8435195800661	<b>2,73</b>
	<b>18622</b>	22 x 22 Ø soldar	10	8435195800678	<b>2,98</b>
	<b>18628</b>	28 x 28 Ø soldar	10	8435195800685	<b>6,85</b>
	<b>18629</b>	H 1/2" x H 1/2" roscar	10	8435195800692	<b>3,59</b>
<b>18630</b>	H 3/4" x H 3/4" roscar	10	8435195800708	<b>5,26</b>	
<b>Cuello corto</b>	<b>19022</b>	22 x 22 Ø soldar	10	8435195800739	<b>2,98</b>
	<b>18631</b>	H 1/2" x H 1/2" roscar	10	8435195834758	<b>3,45</b>

## MONTURA VALVULA CONTROL



	Código	Medida	Caja	Código Barras	€ / Ud.
<b>Empotrar</b>	<b>19023</b>	19/150	36	8435195800746	<b>2,85</b>
	<b>19024</b>	22/150	36	8435195800753	<b>2,99</b>
	<b>19028</b>	1/2"	36	8435195834819	<b>3,07</b>



	Código	Medida	Caja	Código Barras	€ / Ud.
<b>Oculta</b>	<b>19025</b>	19/150	36	8435195800760	<b>2,74</b>
	<b>19026</b>	22/150	36	8435195800777	<b>2,97</b>
	<b>19017</b>	1/2"	36	8435195847864	<b>3,07</b>

## VOLANTE OCULTO ABS



Código	Medida	Caja	Código Barras	€ / Ud.
<b>19041</b>	Única	25	8435195800876	<b>0,49</b>

## VOLANTE OCULTO METÁLICO



Código	Medida	Caja	Código Barras	€ / Ud.
<b>19031</b>	Única	25	8435195800791	<b>1,28</b>

## VOLANTE FACETADO



Código	Medida	Caja	Código Barras	€ / Ud.
<b>19034</b>	Única	25	8435195800807	<b>4,98</b>

• Incluye tapa e índices.

## VOLANTE 3 PUNTAS ABS



Código	Medida	Caja	Código Barras	€ / Ud.
<b>19035</b>	Única	25	8435195800814	<b>1,10</b>

## VOLANTE 3 PUNTAS METÁLICO



Código	Medida	Caja	Código Barras	€ / Ud.
<b>19038</b>	Única	25	8435195800845	<b>2,10</b>

## VOLANTE 3 PUNTAS METALICO CUADRADILLO



Código	Medida	Caja	Código Barras	€ / Ud.
<b>19053</b>	6,5 mm. Ø	25	8435195828221	<b>2,35</b>

# RECAMBIOS VÁLVULAS CONTROL



## ALARGADERA CABEZAL



Código	Medida	Caja	Código Barras	€ / Ud.
<b>19030</b>	Única	25	8435195800784	<b>0,85</b>

## TORNILLO CABEZAL



Código	Medida	Caja	Código Barras	€ / Ud.
<b>98018</b>	M - 5 x 6	25	8435195822274	<b>0,04</b>

## ÍNDICE PARA VOLANTE ABS



Código	Descripción	Caja	Código Barras	€ / Ud.
<b>19036</b>	Azul	25	8435195800821	<b>0,035</b>
<b>19037</b>	Rojo	25	8435195800838	<b>0,035</b>

## ÍNDICE PARA VOLANTE METÁLICO



Código	Descripción	Caja	Código Barras	€ / Ud.
<b>19039</b>	Azul	25	8435195800852	<b>0,035</b>
<b>19040</b>	Rojo	25	8435195800869	<b>0,035</b>

## CASQUILLO CUBRE MONTURAS



Código	Medida	Caja	Código Barras	€ / Ud.
<b>19042</b>	Única	25	8435195800883	<b>0,27</b>

## FLORÓN Y ANILLO







	Código	Medida	Caja	Código Barras	€ / Ud.
<b>Florón</b>	<b>19043</b>	Única	25	8435195800890	<b>0,55</b>
<b>Anillo</b>	<b>29034</b>	Única	25	8435195832761	<b>0,085</b>





## VÁLVULAS DE ESFERA

<b>Válvulas esfera palanca</b>		<b>118</b>
<b>Válvulas esfera cuadradillo</b>		<b>119</b>
<b>Válvulas esfera palomilla</b>		<b>120</b>
<b>Válvulas esfera mini</b>		<b>121</b>



## VÁLVULAS DE ESFERA

### Mando palanca

#### CARACTERÍSTICAS TÉCNICAS:

- PN30. Rosca Gas, ISO 228/1.
- Temperatura máxima 120°C.
- Prensa estopa con guarnición de PTFE.
- Maneta de acero con PVC azul/rojo.

#### VÁLVULA ESFERA H-H PALANCA ACERO



Código	Medida	Caja	Código Barras	€ / Ud.
<b>20011</b>	1/4"	100	8435195800975	<b>4,45</b>
<b>20012</b>	3/8"	100	8435195800982	<b>3,35</b>
<b>20013</b>	1/2"	100	8435195800999	<b>3,98</b>
<b>20014</b>	3/4"	100	8435195801002	<b>5,36</b>
<b>20015</b>	1"	50	8435195801019	<b>8,58</b>
<b>20016</b>	1 1/4"	28	8435195801026	<b>12,95</b>
<b>20017</b>	1 1/2"	16	8435195801033	<b>19,94</b>
<b>20018</b>	2"	8	8435195801040	<b>28,96</b>
<b>20019</b>	2 1/2"	4	8435195801057	<b>66,92</b>
<b>20020</b>	3"	2	8435195801064	<b>95,98</b>
<b>20021</b>	4"	2	8435195801071	<b>136,72</b>

#### VÁLVULA ESFERA M-H PALANCA ACERO



Código	Medida	Caja	Código Barras	€ / Ud.
<b>22005</b>	3/8"	100	8435195801125	<b>3,94</b>
<b>22006</b>	1/2"	100	8435195801132	<b>4,32</b>
<b>22007</b>	3/4"	50	8435195801149	<b>6,18</b>
<b>22008</b>	1"	50	8435195801156	<b>9,86</b>

#### VÁLVULA ESFERA M-M PALANCA ACERO



Código	Medida	Caja	Código Barras	€ / Ud.
<b>22524</b>	3/8"	10	8435195826654	<b>5,26</b>
<b>22508</b>	1/2"	10	8435195822199	<b>5,34</b>
<b>22509</b>	3/4"	10	8435195822205	<b>7,46</b>
<b>22510</b>	1"	10	8435195822212	<b>13,91</b>

#### VÁLVULA ESFERA SOLDAR PALANCA ACERO



Código	Medida	Caja	Código Barras	€ / Ud.
<b>22115</b>	15 x 15 Ø	100	8435195801163	<b>4,30</b>
<b>22118</b>	18 x 18 Ø	100	8435195801170	<b>4,94</b>
<b>22122</b>	22 x 22 Ø	60	8435195801170	<b>6,98</b>
<b>22128</b>	28 x 28 Ø	50	8435195801187	<b>11,36</b>
<b>22135</b>	35 x 35 Ø	10	8435195801194	<b>20,88</b>
<b>22142</b>	42 x 42 Ø	10	8435195820096	<b>33,70</b>
<b>22154</b>	54 x 54 Ø	10	8435195820102	<b>54,72</b>

#### VÁLVULA ESFERA POLIPROPILENO H-H- PALANCA ALUMINIO



Código	Medida	Caja	Código Barras	€ / Ud.
<b>20003</b>	1/2"	20	8435195800913	<b>7,19</b>
<b>20004</b>	3/4"	20	8435195800920	<b>8,53</b>
<b>20005</b>	1"	10	8435195800937	<b>12,39</b>
<b>20006</b>	1 1/4"	5	8435195800944	<b>19,48</b>
<b>20007</b>	1 1/2"	5	8435195800951	<b>30,44</b>
<b>20008</b>	2"	2	8435195800968	<b>42,91</b>





## VÁLVULAS DE ESFERA

### Mando cuadradillo

#### CARACTERÍSTICAS TÉCNICAS:

- PN30. Rosca Gas, ISO 228/1.
- Temperatura máxima 120°C.
- Prensa estopa con guarnición de PTFE.

#### VÁLVULA ESFERA H-H CUADRADILLO "MALLORCA"



Código	Medida	Caja	Código Barras	€ / Ud.
<b>22603</b>	1/2" - 14	20	8435195801309	<b>6,20</b>
<b>22604</b>	3/4" - 14	20	8435195801309	<b>8,22</b>
<b>22605</b>	1" - 16	20	8435195801309	<b>12,95</b>
<b>22606</b>	1 1/4" - 16	20	8435195801309	<b>19,30</b>
<b>22607</b>	1 1/2" - 18	20	8435195801309	<b>29,72</b>
<b>22608</b>	2" - 18	20	8435195801309	<b>42,16</b>

#### VÁLVULA ESFERA M-H CUADRADILLO "MALLORCA"



Código	Medida	Caja	Código Barras	€ / Ud.
<b>22612</b>	1/2" - 14	10	8435195801361	<b>4,95</b>
<b>22613</b>	3/4" - 14	10	8435195801378	<b>6,85</b>
<b>22614</b>	1" - 16	5	8535195801385	<b>10,12</b>

#### VÁLVULA ESFERA ESCUADRA CUADRADILLO



	Código	Medida	Caja	Código Barras	€ / Ud.
<b>M - H</b>	<b>22601</b>	1/2" - 14	10	8435195801286	<b>7,68</b>
<b>M - M</b>	<b>22602</b>	1/2" - 14	10	8435195801293	<b>7,69</b>

#### VÁLVULA ESFERA H-H CUADRADILLO



Código	Medida	Caja	Código Barras	€ / Ud.
<b>22621</b>	1/2" - 18	20	8435195801392	<b>5,98</b>
<b>22622</b>	3/4" - 18	20	8435195801408	<b>9,76</b>
<b>22623</b>	1" - 18	10	8435195801415	<b>13,79</b>
<b>22624</b>	1 1/4" - 25	5	8435195801422	<b>21,81</b>
<b>22625</b>	1 1/2" - 25	5	8435195801439	<b>29,96</b>
<b>22626</b>	2" - 25	5	8435195801446	<b>48,65</b>
<b>22627</b>	2 1/2" - 26	2	8435195820126	<b>104,54</b>
<b>22628</b>	3" - 26	2	8435195820133	<b>154,60</b>
<b>22629</b>	4" - 36	2	8435195820140	<b>271,30</b>

#### VÁLVULA ESFERA M-H CUADRADILLO



Código	Medida	Caja	Código Barras	€ / Ud.
<b>22630</b>	1/2" - 18	20	8435195801453	<b>5,31</b>
<b>22631</b>	3/4" - 18	20	8435195801460	<b>8,60</b>
<b>22632</b>	1" - 18	10	8435195801477	<b>12,53</b>



## VÁLVULAS DE ESFERA

*Mando palomilla*

### CARACTERÍSTICAS TÉCNICAS:

- PN30. Rosca Gas, ISO 228/1.
- Temperatura máxima 120°C.
- Prensa estopa con guarnición de PTFE.
- Maneta palomilla de aluminio roja o azul.

### VÁLVULA ESFERA H-H PALOMILLA



Código	Medida	Caja	Código Barras	€ / Ud.
<b>20501</b>	1/4"	100	8435195826661	<b>4,58</b>
<b>20502</b>	3/8"	100	8435195801088	<b>3,84</b>
<b>20503</b>	1/2"	100	8435195801095	<b>3,98</b>
<b>20504</b>	3/4"	50	8435195801101	<b>5,70</b>
<b>20505</b>	1"	50	8435195801118	<b>8,93</b>

### VÁLVULA ESFERA M-H PALOMILLA



Código	Medida	Caja	Código Barras	€ / Ud.
<b>22501</b>	1/4"	100	8435195826678	<b>4,78</b>
<b>22502</b>	3/8"	100	8435195826685	<b>4,45</b>
<b>22503</b>	1/2"	100	8435195801200	<b>3,85</b>
<b>22504</b>	3/4"	60	8435195801217	<b>5,76</b>
<b>22505</b>	1"	50	8435195801224	<b>9,29</b>

### VÁLVULA ESFERA M-M PALOMILLA



Código	Medida	Caja	Código Barras	€ / Ud.
<b>22511</b>	1/2"	10	8435195822229	<b>5,35</b>
<b>22512</b>	3/4"	10	8435195822236	<b>7,40</b>
<b>22517</b>	1"	10	8435195822243	<b>11,46</b>

### VÁLVULA ESFERA ESCUADRA PALOMILLA



	Código	Medida	Caja	Código Barras	€ / Ud.
<b>M - H</b>	<b>22506</b>	1/2" x 1/2"	10	8435195801231	<b>7,76</b>

	Código	Medida	Caja	Código Barras	€ / Ud.
<b>M - M</b>	<b>22507</b>	1/2" x 1/2"	10	8435195801248	<b>6,91</b>

- Maneta palomilla de aluminio amarilla.

### VÁLVULA ESFERA SOLDAR PALOMILLA



Código	Medida	Caja	Código Barras	€ / Ud.
<b>22515</b>	15 x 15 Ø	100	8435195801255	<b>4,19</b>
<b>22518</b>	18 x 18 Ø	100	8435195801262	<b>4,22</b>
<b>22522</b>	22 x 22 Ø	60	8435195801279	<b>7,42</b>

## VÁLVULAS DE ESFERA



### CARACTERÍSTICAS TÉCNICAS:

• PN16. Rosca Gas, ISO 228/1.

• Temperatura máxima 100°C.

### VÁLVULA ESFERA MINI H-H



Código	Medida	Caja	Código Barras	€ / Ud.
<b>23001</b>	1/4"	20	8435195826692	<b>3,96</b>
<b>23002</b>	3/8"	20	8435195801484	<b>3,63</b>
<b>23003</b>	1/2"	20	8435195801491	<b>3,71</b>
<b>23004</b>	3/4"	20	8435195801507	<b>8,58</b>

### VÁLVULA ESFERA MINI M-H



Código	Medida	Caja	Código Barras	€ / Ud.
<b>23501</b>	1/4"	20	8435195801514	<b>3,43</b>
<b>23502</b>	3/8"	20	8435195801521	<b>3,30</b>
<b>23503</b>	1/2"	20	8435195801538	<b>3,60</b>
<b>23504</b>	3/4"	20	8435195801545	<b>5,99</b>





## GRIFOS CURVOS Y ACCESORIOS

**Grifo curvo esfera**



**124**

**Grifo curvo candado**



**125**

**Grifo curvo polipropileno y antihielo**



**125**

**Racor, enchufe, unión y boquilla adaptables**



**126**

## GRIFOS CURVOS



### GRIFO CURVO ESFERA



Código	Medida	Caja	Código Barras	€ / Ud.
<b>24506</b>	1/2" x 3/4"	100	8435195801651	<b>4,36</b>
<b>24507</b>	3/4" x 1"	50	8435195801668	<b>6,40</b>
<b>24519</b>	3/4" x 3/4"	20	8435195832778	<b>10,30</b>
<b>24508</b>	1" x 1 1/4"	20	8435195801675	<b>12,35</b>
<b>24528</b>	1" x 1"	20	8435195832785	<b>12,48</b>

- PN16.
- Latón EN 12165 cromado.
- Temperatura máxima 90°C.
- Prensa estopa con guarnición de PTFE.
- Maneta de acero con PVC azul.
- Racor 2 piezas conexión manguera.
- Rompe chorros en Nylon.

### GRIFO CURVO ESFERA RACOR RÁPIDO MANGUERA



Código	Medida	Caja	Código Barras	€ / Ud.
<b>24522</b>	1/2" x 3/4"	40	8435195822281	<b>6,46</b>
<b>24523</b>	3/4" x 1"	20	8435195822298	<b>8,85</b>
<b>24524</b>	3/4" x 3/4"	10	8435195822304	<b>14,98</b>

- PN16.
- Latón EN 12165 cromado.
- Temperatura máxima 90°C.
- Prensa estopa con guarnición de PTFE.
- Maneta de acero con PVC azul.
- Racor rápido conexión manguera.

### GRIFO CURVO ESFERA SALIDA DOBLE RACOR RÁPIDO MANGUERA



Código	Medida	Caja	Código Barras	€ / Ud.
<b>24509</b>	1/2" x 3/4"	100	8435195801651	<b>11,99</b>

- PN16.
- Latón EN 12165 cromado.
- Temperatura máxima 90°C.
- Prensa estopa con guarnición de PTFE.
- Maneta de acero con PVC azul.
- Racor rápido conexión manguera.

## GRIFOS CURVOS



### GRIFO CURVO PARA CANDADO

Código	Medida	Caja	Código Barras	€ / Ud.
<b>24525</b>	1/2" x 3/4"	40	8435195822250	<b>7,18</b>



- PN16.
- Latón EN 12165 cromado.
- Temperatura máxima 90°C.
- Prensa estopa con guarnición de PTFE.
- Maneta de acero con PVC rojo.
- Racor 2 piezas conexión manguera.

### GRIFO CURVO POLIPROPILENO

Código	Medida	Caja	Código Barras	€ / Ud.
<b>24503</b>	1/2" x 3/4"	40	8435195801620	<b>10,69</b>
<b>24504</b>	3/4" x 1"	25	8435195801637	<b>15,98</b>
<b>24505</b>	1" x 1 1/4"	15	8435195801644	<b>21,65</b>



- PN16.
- Temperatura: de 0°C. a 75°C.
- Prensa estopa con guarnición de PTFE con junta tórica NBR.
- Maneta de aluminio con PVC rojo.
- Conexión manguera.
- No adecuado para gas.

### GRIFO CURVO ANTIHIELO NÓRDICO

Código	Medida	Caja	Código Barras	€ / Ud.
<b>24500</b>	1/2" x 3/4"	40	8435195820065	<b>11,84</b>
<b>24501</b>	3/4" x 1"	25	8435195820072	<b>16,86</b>
<b>24502</b>	1" x 1 1/4"	15	8435195820089	<b>23,89</b>



- PN16.
- Temperatura: de -20°C. a +75°C.
- Prensa estopa con guarnición de PTFE con junta tórica NBR.
- Maneta de aluminio con PVC azul.
- Conexión manguera.
- No adecuado para gas.
- Resistente al hielo.

## GRIFOS CURVOS

Accesorios



### RACOR DOS PIEZAS NÍQUEL



Código	Medida	Caja	Código Barras	€ / Ud.
<b>71504</b>	1/2" x 3/4"	25	8435195811681	<b>0,99</b>
<b>71505</b>	3/4" x 1"	25	8435195811698	<b>1,36</b>
<b>71507</b>	1" x 1"	25	8435195826708	<b>2,39</b>
<b>71506</b>	1" x 1 1/4"	25	8435195811704	<b>4,71</b>

### RACOR HEMBRA SISTEMA ANCLAJE ADAPTABLE S/COLOR



Código	Medida	Caja	Código Barras	€ / Ud.
<b>24541</b>	3/4"	10	8435195822311	<b>2,17</b>
<b>24542</b>	1"	10	8435195822328	<b>3,88</b>

### RACOR HEMBRA SISTEMA ANCLAJE ADAPTABLE NÍQUEL



Código	Medida	Caja	Código Barras	€ / Ud.
<b>24544</b>	3/4"	10	8435195822335	<b>2,23</b>
<b>24545</b>	1"	10	8435195822342	<b>2,86</b>

### ENCHUFE ADAPTABLE A MANGUERA S/COLOR



Código	Medida	Caja	Código Barras	€ / Ud.
<b>24546</b>	1/2"	10	8435195828023	<b>7,99</b>
<b>24547</b>	3/4"	10	8435195822359	<b>10,71</b>

### UNIÓN MANGUERA - MANGUERA S/COLOR



Código	Medida	Caja	Código Barras	€ / Ud.
<b>24549</b>	1/2"	10	8435195828030	<b>6,10</b>
<b>24550</b>	3/4"	10	8435195822373	<b>8,99</b>

### BOQUILLA GRADUABLE CONTROL DE SALIDA S/COLOR



Código	Medida	Caja	Código Barras	€ / Ud.
<b>24553</b>	9,5 Ø	10	8435195822397	<b>8,37</b>

- Adaptable a enchufe manguera rápido.





## GRIFOS DECORATIVOS

**Grifos decorativos**



**128**

## GRIFOS DECORATIVOS



### GRIFO JARDÍN DECORATIVO "RENACIMIENTO" S/COLOR



Código	Medida	Caja	Código Barras	€ / Ud.
<b>24531</b>	1/2"	10	8435195822403	<b>25,93</b>

### GRIFO JARDÍN DECORATIVO "PATO" S/COLOR



Código	Medida	Caja	Código Barras	€ / Ud.
<b>24532</b>	1/2"	10	8435195822410	<b>23,88</b>

### GRIFO JARDÍN DECORATIVO "PÁJARO" S/COLOR



Código	Medida	Caja	Código Barras	€ / Ud.
<b>24533</b>	1/2"	10	8435195822427	<b>24,88</b>

### GRIFO JARDÍN DECORATIVO "RANA" S/COLOR



Código	Medida	Caja	Código Barras	€ / Ud.
<b>24534</b>	1/2"	10	8435195822434	<b>24,99</b>

### GRIFO JARDÍN DECORATIVO "PEZ" S/COLOR



Código	Medida	Caja	Código Barras	€ / Ud.
<b>24535</b>	1/2"	10	8435195822441	<b>23,29</b>

### GRIFO JARDÍN DECORATIVO "GALLO" S/COLOR



Código	Medida	Caja	Código Barras	€ / Ud.
<b>24536</b>	1/2"	10	8435195822458	<b>23,95</b>

## GRIFOS DECORATIVOS

### GRIFO CODILLO S/COLOR



	Código	Medida	Caja	Código Barras	€ / Ud.
Sin racor	<b>24510</b>	1/2"	10	8435195801682	<b>6,20</b>
	<b>24512</b>	3/4"	10	8435195801699	<b>7,25</b>



	Código	Medida	Caja	Código Barras	€ / Ud.
Con racor	<b>24515</b>	1/2"	10	8435195801729	<b>6,83</b>
	<b>24516</b>	3/4"	10	8435195801736	<b>9,98</b>
	<b>24526</b>	3/4" x 1"	10	8435195833966	<b>14,70</b>

### GRIFO CODILLO CROMADO



	Código	Medida	Caja	Código Barras	€ / Ud.
Sin racor	<b>24513</b>	1/2"	10	8435195801705	<b>6,91</b>
	<b>24514</b>	3/4"	10	843519581712	<b>7,64</b>



	Código	Medida	Caja	Código Barras	€ / Ud.
Con racor	<b>24517</b>	1/2"	10	8435195801743	<b>7,42</b>
	<b>24518</b>	3/4"	10	8435195801750	<b>14,98</b>

### PLACA ATORNILLAR CROMADA



	Código	Medida	Caja	Código Barras	€ / Ud.
	<b>25519</b>	M-H 1/2"	10	8435195801989	<b>5,26</b>
	<b>25521</b>	H-H 1/2"	10	8435195802009	<b>5,26</b>

### GRIFO DE LATÓN PARA BARRIL



	Código	Descripción	Caja	Código Barras	€ / Ud.
	<b>24520</b>	Cón cánula	20	8435195820300	<b>2,52</b>
	<b>24521</b>	Sin cánula	20	8435195820317	<b>2,28</b>





## REDUCTORES DE PRESIÓN Y MANÓMETROS

**Reductores de presión**



**132**

**Manómetros**



**133**

# REDUCTORES DE PRESIÓN



## REDUCTOR DE PRESIÓN CON RACORES H-H



Código	Medida	Caja	Código Barras	€ / Ud.
<b>25601</b>	1/2"	5	8435195802016	<b>35,97</b>
<b>25602</b>	3/4"	5	8435195802023	<b>57,68</b>
<b>25603</b>	1"	5	8435195802030	<b>65,10</b>
<b>25604</b>	1 1/4"	4	8435195802047	<b>123,59</b>
<b>25605</b>	1 1/2"	4	8435195802054	<b>131,52</b>
<b>25606</b>	2"	2	8435195802061	<b>209,17</b>
<b>25607</b>	2 1/2"	2	8435195802078	<b>241,82</b>
<b>25608</b>	3"	1	8435195824643	<b>347,32</b>

- PN25.
- Fabricado en latón niquelado.
- Regulación de 0,5 a 6 Bares.
- Temperatura máxima 80°C.
- Asiento y varillas de acero inoxidable.
- Con conexión para manómetro de presión en ambos lados.
- Pretarado a 3 bares.

## REDUCTOR DE PRESIÓN SIN RACORES H-H



Código	Medida	Caja	Código Barras	€ / Ud.
<b>25630</b>	3/4"	5	8435195832792	<b>18,54</b>
<b>25631</b>	1"	5	8435195832808	<b>51,42</b>
<b>25632</b>	1 1/4"	2	8435195832815	<b>99,60</b>
<b>25633</b>	1 1/2"	2	8435195832822	<b>103,98</b>
<b>25634</b>	2"	2	8435195832839	<b>166,35</b>

- PN25.
- Fabricado en latón. (Ref. 25630 Fabricado en latón niquelado).
- Regulación de 0,5 a 6 Bares.
- Temperatura máxima 80°C.
- Asiento y varillas de acero inoxidable.
- Con conexión para manómetro de presión en ambos lados.
- Pretarado a 3 bares.

## REDUCTOR DE PRESIÓN PARA CALENTADOR DE AGUA H-H



Código	Medida	Caja	Código Barras	€ / Ud.
<b>25610</b>	1/2"	5	8435195802085	<b>17,09</b>

- PN15.
- Fabricado en latón niquelado.
- De 1 a 4 Bares.
- Temperatura máxima 80°C.
- Asiento de latón.
- Con conexión para manómetro de presión en ambos lados.



## REDUCTORES DE PRESIÓN

### Manómetros

#### DISPOSITIVO ANTI GOLPE DE ARIETE



Código	Medida	Caja	Código Barras	€/ Ud.
<b>25611</b>	1/2"	1	8435195824650	<b>21,96</b>

- PN10.
- Temperatura máxima 100°C.
- Fabricado en latón. Muelle de acero inox.
- Protege el reductor de presión.
- Mejora el funcionamiento y reduce el ruido.

#### MANÓMETRO SALIDA INFERIOR



Código	Medida	Caja	Código Barras	€/ Ud.
<b>25702</b>	1/4" 0 a 6 Bares	1	8435195823233	<b>5,31</b>
<b>25703</b>	1/4" 0 a 10 Bares	1	8435195823240	<b>5,31</b>
<b>25704</b>	1/4" 0 a 16 Bares	1	8435195832846	<b>5,31</b>

- Caja ABS negra con esfera y aguja de aluminio. Interiores y racor en latón.
- Temperatura ambiente: -20 a +60°C. Fluido máximo: 60°C.
- Precisión CL. 1,6.

#### MANÓMETRO SALIDA POSTERIOR



Código	Medida	Caja	Código Barras	€/ Ud.
<b>25712</b>	1/4" 0 a 6 Bares	1	8435195823257	<b>5,31</b>
<b>25713</b>	1/4" 0 a 10 Bares	1	8435195823264	<b>5,31</b>

- Caja ABS negra con esfera y aguja de aluminio. Interiores y racor en latón.
- Temperatura ambiente: -20 a +60°C. Fluido máximo: 60°C.
- Precisión CL. 1,6.

#### MANÓMETRO SALIDA INFERIOR CON GLICERINA



Código	Medida	Caja	Código Barras	€/ Ud.
<b>25725</b>	1/4" x 63 0 a 6 Bares	1	843519583283	<b>9,40</b>
<b>25726</b>	1/4" x 63 0 a 10 Bares	1	8435195832860	<b>9,40</b>
<b>25730</b>	1/4" x 63 0 a 40 Bares	1	8435195835892	<b>11,83</b>
<b>25729</b>	1/4" x 63 0 a 60 Bares	1	8435195835885	<b>11,83</b>
<b>25727</b>	1/2" x 100 0 a 10 Bares	1	8435195832877	<b>23,93</b>
<b>25728</b>	1/2" x 100 0 a 40 Bares	1	8435195835878	<b>28,01</b>

- Caja acero inox. con esfera ABS y aguja de aluminio. Interiores y racor en latón.
- Temperatura ambiente: -20 a +60°C. Fluido máximo: 60°C.
- Precisión CL. 1,6.

#### MANÓMETRO SALIDA POSTERIOR CON GLICERINA



Código	Medida	Caja	Código Barras	€/ Ud.
<b>25742</b>	1/4" x 63 0 a 6 Bares	1	8435195832884	<b>10,54</b>
<b>25743</b>	1/4" x 63 0 a 10 Bares	1	8435195832891	<b>10,54</b>

- Caja acero inox. con esfera ABS y aguja de aluminio. Interiores y racor en latón.
- Temperatura ambiente: -20 a +60°C. Fluido máximo: 60°C.
- Precisión CL. 1,6.







## VÁLVULAS DE RETENCIÓN Y FILTROS

<b>Válvulas de retención H-H</b>		<b>136</b>
<b>Filtros</b>		<b>137</b>
<b>Válvulas de retención M-M</b>		<b>137</b>
<b>Válvulas de retención clapeta</b>		<b>138</b>
<b>Filtro colador tipo "Y"</b>		<b>138</b>
<b>Válvulas de compuerta</b>		<b>138</b>
<b>Válvulas esfera 3 vías</b>		<b>139</b>
<b>Válvulas esfera con retención incorporada</b>		<b>139</b>
<b>Válvulas esfera contador y accesorios</b>		<b>140</b>

## VÁLVULAS DE RETENCIÓN Y FILTROS



### VÁLVULA DE RETENCIÓN TIPO "YORK" H-H



Código	Medida	Caja	Código Barras	€ / Ud.
<b>26003</b>	1/2"	50	8435195802092	<b>3,93</b>
<b>26004</b>	3/4"	50	8435195802108	<b>4,62</b>
<b>26005</b>	1"	40	8435195802115	<b>7,32</b>
<b>26006</b>	1 1/4"	20	8435195802122	<b>11,84</b>
<b>26007</b>	1 1/2"	20	8435195802139	<b>16,75</b>
<b>26008</b>	2"	10	8435195802146	<b>23,93</b>
<b>26009</b>	2 1/2"	1	8435195802153	<b>45,56</b>
<b>26010</b>	3"	1	8435195802160	<b>59,97</b>
<b>26011</b>	4"	1	8435195802177	<b>109,17</b>

- PN12 (3/8" a 1") PN10 (1 1/4" a 2") PN8 (2 1/2" a 4").
- Fabricado en latón.
- Disco de Nylon y muelle en acero inoxidable.
- Temperatura máxima: 90°C.
- Cierre con goma NBR.

### VÁLVULA DE RETENCIÓN CON FILTRO



Código	Medida	Caja	Código Barras	€ / Ud.
<b>26016</b>	1/2"	20	8435195824377	<b>2,80</b>
<b>26017</b>	3/4"	20	8435195824384	<b>3,99</b>
<b>26018</b>	1"	10	8435195824391	<b>5,50</b>
<b>26019</b>	1 1/4"	5	8435195824407	<b>9,35</b>
<b>26020</b>	1 1/2"	5	8435195824414	<b>12,14</b>
<b>26021</b>	2"	5	8435195824421	<b>19,20</b>
<b>26022</b>	2 1/2"	1	8435195824438	<b>34,62</b>
<b>26023</b>	3"	1	8435195824445	<b>56,75</b>
<b>26024</b>	4"	1	8435195824636	<b>76,85</b>

- PN16 (1/2" a 1") PN10 (1 1/4" a 2") PN8 (2 1/2" a 4").
- Fabricado en latón.
- Disco de Nylon.
- Muelle y filtro en acero inox.
- Temperatura máxima: 80°C.
- Cierre con goma NBR.

### VÁLVULA RETENCIÓN CIERRE METÁLICO H-H



Código	Medida	Caja	Código Barras	€ / Ud.
<b>26101</b>	3/8"	10	8435195826715	<b>4,80</b>
<b>26102</b>	1/2"	50	8435195802191	<b>4,50</b>
<b>26103</b>	3/4"	40	8435195802207	<b>6,39</b>
<b>26104</b>	1"	40	8435195802214	<b>8,13</b>
<b>26105</b>	1 1/4"	20	8435195802221	<b>11,76</b>
<b>26106</b>	1 1/2"	20	8435195802238	<b>19,30</b>
<b>26107</b>	2"	10	8435195802245	<b>28,64</b>
<b>26108</b>	2 1/2"	1	8435195802252	<b>54,65</b>
<b>26109</b>	3"	1	8435195802269	<b>87,78</b>
<b>26110</b>	4"	1	8435195826722	<b>126,05</b>

- PN25 (3/8" a 1") PN16 (1 1/4" a 2") PN10 (2 1/2" a 4").
- Fabricado en latón.
- Disco y guía de latón.
- Temperatura máxima: 80°C.
- Cierre con goma NBR.

## FILTRO ACERO INOXIDABLE



Código	Medida	Caja	Código Barras	€ / Ud.
<b>26503</b>	1/2"	50	8435195802276	<b>0,99</b>
<b>26504</b>	3/4"	50	8435195802283	<b>1,18</b>
<b>26505</b>	1"	20	8435195802290	<b>1,49</b>
<b>26506</b>	1 1/4"	10	8435195802306	<b>1,88</b>
<b>26507</b>	1 1/2"	10	8435195802313	<b>2,25</b>
<b>26508</b>	2"	10	8435195802320	<b>2,97</b>
<b>26509</b>	2 1/2"	2	8435195802337	<b>7,95</b>
<b>26510</b>	3"	2	8435195802344	<b>8,75</b>
<b>26511</b>	4"	2	8435195802351	<b>10,99</b>

- Racor de Nylon.
- Malla de acero inoxidable:  
de 1/2" a 2" perforada a 1,2 mm.  
de 2 1/2" a 4" perforada a 2 mm.
- Para agua, aire y fluidos no agresivos.
- Para válvulas de retención con rosca Hembra - Hembra.

## FILTRO ABS



Código	Medida	Caja	Código Barras	€ / Ud.
<b>26516</b>	1/2"	50	8435195802368	<b>0,70</b>
<b>26517</b>	3/4"	50	8435195802375	<b>0,76</b>
<b>26518</b>	1"	20	8435195802382	<b>0,93</b>
<b>26519</b>	1 1/4"	10	8435195802399	<b>1,51</b>
<b>26520</b>	1 1/2"	10	8435195802405	<b>1,64</b>
<b>26521</b>	2"	10	8435195802412	<b>2,47</b>

- Para válvulas de retención con rosca Hembra - Hembra.

## VÁLVULA RETENCIÓN M-M



Código	Medida	Caja	Código Barras	€ / Ud.
<b>26202</b>	1/2"	50	8435195822465	<b>6,33</b>
<b>26203</b>	3/4"	40	8435195822472	<b>6,55</b>
<b>26204</b>	1"	5	8435195826739	<b>9,92</b>

- PN16.
- Fabricado en latón.
- Disco de nylon.
- Roscas Macho - Macho.
- Temperatura máxima: 80°C.

# VÁLVULAS DE RETENCIÓN Y FILTROS



## VÁLVULA RETENCIÓN CLAPETA H-H



Código	Medida	Caja	Código Barras	€ / Ud.
<b>26601</b>	1/2"	50	8435195802429	<b>5,40</b>
<b>26602</b>	3/4"	50	8435195802436	<b>7,10</b>
<b>26603</b>	1"	20	8435195802443	<b>10,85</b>
<b>26604</b>	1 1/4"	10	8435195802450	<b>23,15</b>
<b>26605</b>	1 1/2"	10	8435195802467	<b>28,97</b>
<b>26606</b>	2"	10	8435195802474	<b>39,94</b>
<b>26607</b>	2 1/2"	2	8435195802481	<b>76,98</b>
<b>26608</b>	3"	2	8435195802498	<b>98,38</b>
<b>26609</b>	4"	2	8435195802504	<b>145,58</b>

- PN16 (1/2" a 1") PN10 (1 1/4" a 2") PN8 (2 1/2" a 4").
- Fabricado en latón.
- Clapeta de latón.
- Temperatura máxima: 90°C.
- Cierre con goma NBR.

## FILTRO COLADOR TIPO "Y" H-H



Código	Medida	Caja	Código Barras	€ / Ud.
<b>26613</b>	1/2"	30	8435195802511	<b>4,67</b>
<b>26614</b>	3/4"	20	8435195802528	<b>6,35</b>
<b>26615</b>	1"	10	8435195802535	<b>8,66</b>
<b>26616</b>	1 1/4"	6	8435195802542	<b>17,89</b>
<b>26617</b>	1 1/2"	4	8435195802559	<b>27,95</b>
<b>26618</b>	2"	2	8435195802566	<b>42,39</b>
<b>26619</b>	2 1/2"	1	8435195820553	<b>84,84</b>
<b>26620</b>	3"	1	8435195820560	<b>99,86</b>
<b>26621</b>	4"	1	8435195820577	<b>164,30</b>

- PN16.
- Fabricado en latón.
- Filtro de acero inoxidable.
- Temperatura máxima: 100°C.

## VÁLVULA COMPUERTA CON CIERRE DE GOMA H-H



Código	Medida	Caja	Código Barras	€ / Ud.
<b>26622</b>	1/2"	10	8435195822489	<b>9,25</b>
<b>26623</b>	3/4"	10	8435195822496	<b>11,83</b>
<b>26624</b>	1"	5	8435195822502	<b>17,42</b>
<b>26625</b>	1 1/4"	5	8435195822519	<b>28,54</b>
<b>26626</b>	1 1/2"	5	8435195822526	<b>40,52</b>
<b>26627</b>	2"	2	8435195822533	<b>61,98</b>
<b>26628</b>	2 1/2"	1	8435195822540	<b>114,66</b>
<b>26629</b>	3"	1	8435195822557	<b>159,60</b>
<b>26630</b>	4"	1	8435195822564	<b>322,56</b>

- PN16.
- Fabricado en latón.
- Cierre compuerta latón + NBR vulcanizado.
- Temperatura máxima: 80°C.
- Maneta roja de acero.

## VÁLVULA COMPUERTA CON CIERRE DE LATÓN H-H



Código	Medida	Caja	Código Barras	€ / Ud.
<b>26640</b>	1/2"	10	8435195822571	<b>5,24</b>
<b>26641</b>	3/4"	10	8435195822588	<b>6,35</b>
<b>26642</b>	1"	5	8435195822595	<b>9,31</b>
<b>26643</b>	1 1/4"	5	8435195822601	<b>14,18</b>
<b>26644</b>	1 1/2"	5	8435195822618	<b>19,88</b>
<b>26645</b>	2"	2	8435195822625	<b>30,66</b>
<b>26646</b>	2 1/2"	1	8435195822632	<b>57,88</b>
<b>26647</b>	3"	1	8435195822649	<b>81,70</b>
<b>26648</b>	4"	1	8435195822656	<b>139,68</b>

- PN10.
- Fabricado en latón.
- Cierre disco de latón.
- Temperatura máxima: 110°C.
- Maneta roja de acero.

## VÁLVULA ESFERA 3 VÍAS PASO "T"



Código	Medida	Caja	Código Barras	€ / Ud.
<b>22552</b>	1/2"	10	8435195835380	<b>27,78</b>
<b>22553</b>	3/4"	10	8435195835397	<b>45,40</b>
<b>22554</b>	1"	5	8435195835403	<b>66,87</b>
<b>22555</b>	1 1/4"	5	8435195835410	<b>97,78</b>
<b>22556</b>	1 1/2"	1	8435195835427	<b>152,42</b>
<b>22557</b>	2"	1	8435195835434	<b>246,05</b>

- PN16.
- Temperatura máxima: 130°C.
- Válvula con bola de latón.

## VÁLVULA ESFERA 3 VÍAS PASO "L"



Código	Medida	Caja	Código Barras	€ / Ud.
<b>22542</b>	1/2"	10	8435195835311	<b>28,17</b>
<b>22543</b>	3/4"	10	8435195835328	<b>45,96</b>
<b>22544</b>	1"	5	8435195835335	<b>66,87</b>
<b>22545</b>	1 1/4"	5	8435195835342	<b>99,23</b>
<b>22546</b>	1 1/2"	1	8435195835359	<b>152,42</b>
<b>22547</b>	2"	1	8435195835366	<b>246,05</b>

- PN16.
- Temperatura máxima: 130°C.
- Válvula con bola de latón.

## VÁLVULA ESFERA CON RETENCIÓN INCORPORADA



Código	Medida	Caja	Código Barras	€ / Ud.
<b>26660</b>	1/2"	10	8435195823271	<b>8,96</b>
<b>26661</b>	3/4"	10	8435195823288	<b>14,95</b>
<b>26662</b>	1"	5	8435195823295	<b>24,45</b>

- PN16.
- Latón EN 12165 niquelado.
- Temperatura máxima: 95°C.
- Prensa estopa con guarnición de PTFE.
- Cierre retención EPDM.
- Muelle en acero inoxidable.

# VÁLVULAS DE RETENCIÓN Y FILTROS



## VÁLVULA ESFERA ENTRADA CONTADOR ORIENTABLE



Código	Medida	Caja	Código Barras	€ / Ud.
<b>26666</b>	DN15 Racor 3/4"	10	8435195823301	<b>16,84</b>
<b>26667</b>	DN15 Racor 7/8"	10	8435195824698	<b>18,97</b>

- Cuerpo, esfera, conexiones y eje fabricado en latón.
- Brida orientable que permite su colocación en cualquier batería.
- Juntas tóricas NBR y juntas de teflón PTFE.

## VÁLVULA ESFERA ENTRADA CONTADOR ORIENTABLE



Código	Medida	Caja	Código Barras	€ / Ud.
<b>26676</b>	DN15 Racor 3/4"	10	8435195826746	<b>11,85</b>

- Cuerpo, esfera, conexiones y eje fabricado en latón.
- Brida orientable que permite su colocación en cualquier batería.
- Juntas tóricas NBR y juntas de teflón PTFE.

## VÁLVULA ESFERA SALIDA CONTADOR ANTIRRETORNO



Código	Medida	Caja	Código Barras	€ / Ud.
<b>26675</b>	DN15 Racor 3/4"	10	8435195823332	<b>11,40</b>

- Cuerpo, esfera, conexiones y eje fabricado en latón.
- Provista de dispositivo antirretorno en la salida.
- Juntas tóricas NBR y juntas de teflón PTFE.

## MANGUITO CONTADOR



Código	Medida	Caja	Código Barras	€ / Ud.
<b>26670</b>	DN20 Racor 3/4"	10	8435195823318	<b>2,24</b>
<b>26671</b>	DN15 Racor 7/8"	10	8435195823325	<b>2,50</b>
<b>26673</b>	DN15 Racor 3/4"	10	8435195824704	<b>2,24</b>
<b>26678</b>	Racor 3/4" Izq.-7/8" Drch.	10	8435195836226	<b>2,80</b>

## JUNTA CAUCHO BRIDA ORIENTABLE



Código	Medida	Caja	Código Barras	€ / Ud.
<b>99344</b>	Única	10	8435195832907	<b>0,55</b>

## CUERPO BRIDA NÍQUEL



Código	Medida	Caja	Código Barras	€ / Ud.
<b>99083</b>	3/4"	5	8435195823363	<b>4,75</b>





## LATERAL BRIDA NÍQUEL



Código	Medida	Caja	Código Barras	€ / Ud.
<b>99093</b>	3/4"	5	8435195823400	<b>2,29</b>



## RACORES DE CONTADOR Y ACCESORIOS

<b>Racores de contador y accesorios</b>		<b>142</b>
<b>Racor telescópico</b>		<b>142</b>
<b>Purgador con tornillo</b>		<b>142</b>
<b>Hornacina para contador</b>		<b>142</b>

## RACORES DE CONTADOR Y ACCESORIOS



### RACOR CONTADOR ROSCAR (Racor, tuerca y junta)



Código	Medida	Caja	Código Barras	€ / Ud.
<b>99522</b>	1/2" x 1/2"	25	8435195816617	<b>4,29</b>
<b>98080</b>	5/8" x 1/2"	25	8435195816624	<b>4,96</b>
<b>89081A</b>	3/4" x 1/2"	25	8435195816631	<b>2,81</b>
<b>89083</b>	7/8" x 1/2"	25	8435195816648	<b>3,56</b>
<b>89085A</b>	1" x 3/4"	10	8435195816655	<b>4,68</b>
<b>89076</b>	1 1/4" x 1"	5	8435195816662	<b>7,92</b>
<b>89077</b>	1 1/2" x 1 1/4"	5	8435195816679	<b>10,86</b>
<b>89078</b>	2" x 1 1/2"	2	8435195816686	<b>14,51</b>
<b>98079</b>	2 1/2" x 2"	2	8435195816693	<b>21,99</b>

### RACOR CONTADOR SOLDAR (Racor, purgador, tuerca y junta)



Código	Medida	Caja	Código Barras	€ / Ud.
<b>89080A</b>	7/8" x 18/22	25	8435195816709	<b>4,45</b>
<b>89083A</b>	3/4" x 18	25	8435195816716	<b>4,45</b>

### RACOR TELESCÓPICO

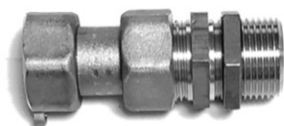

Código	Medida	Caja	Código Barras	€ / Ud.
<b>98061</b>	7/8" x 3/4" x 90 mm.	5	8435195824872	<b>18,99</b>
<b>98101</b>	3/4" x 3/4" x 66 mm.	5	8435195824711	<b>12,99</b>
<b>98105</b>	3/4" x 3/4" x 90 mm.	5	8435195826753	<b>18,16</b>

### PURGADOR CON TORNILLO S/COLOR



Código	Medida	Caja	Código Barras	€ / Ud.
<b>89090</b>	1/8"	25	8435195816730	<b>0,85</b>

### JUNTAS PARA RACOR CONTADOR



Código	Medida	Caja	Código Barras	€ / Ud.
<b>83604</b>	1/2" 14 x 18,5 x 2	100	8435195822663	<b>0,035</b>
<b>89092</b>	3/4" 17 x 23,5 x 2,5	100	8435195816754	<b>0,080</b>
<b>89101</b>	5/8" 21 x 14 x 2	100	8435195816785	<b>0,080</b>
<b>89093</b>	7/8" 21 x 27 x 2,5	100	8435195816761	<b>0,090</b>
<b>84510</b>	7/8" 22 x 27 x 2,5	100	8435195816778	<b>0,090</b>
<b>89091</b>	1" 22 x 30 x 2,5	100	8435195816747	<b>0,120</b>
<b>83511</b>	1 1/4" 29 x 38 x 2,5	25	8435195824145	<b>0,180</b>
<b>83512</b>	1 1/2" 35 x 45 x 3	25	8435195825152	<b>0,390</b>
<b>83513</b>	2" 44 x 55 x 3	25	8435195825169	<b>0,420</b>
<b>83510</b>	2 1/2" 50 x 69 x 4	10	8435195823424	<b>0,510</b>

### HORNACINA PARA CONTADOR DE AGUA ACERO INOX.



Código	Medida	Caja	Código Barras	€ / Ud.
<b>90091</b>	400 x 300 x 110	1	8435195816792	<b>165,65</b>

- Tiene 2 entradas.





## ACCESORIOS PARA TUBO DE POLIETILENO

**Anillo de nylon**



**144**

**Anillo de latón**



**146**

**Anillo de acero inox. con bridas**



**148**

**Recambios**



**150**



## ACCESORIOS TUBO POLIETILENO

Anillo de nylon

### RACOR RECTO HEMBRA A TUBO anillo de nylon



Código	Medida	Caja	Código Barras	€ / Ud.
<b>30003</b>	1/2" x 20 Ø	25	8435195802689	<b>2,98</b>
<b>30004</b>	3/4" x 25 Ø	15	8435195802696	<b>3,97</b>
<b>30005</b>	1" x 32 Ø	10	8435195802702	<b>6,27</b>
<b>30006</b>	1 1/4" x 40 Ø	5	8435195802719	<b>10,49</b>
<b>30007</b>	1 1/2" x 50 Ø	6	8435195802726	<b>16,95</b>
<b>30008</b>	2" x 63 Ø	4	8435195802733	<b>24,57</b>

### RACOR RECTO MACHO A TUBO anillo de nylon



Código	Medida	Caja	Código Barras	€ / Ud.
<b>31503</b>	1/2" x 20 Ø	40	8435195802832	<b>2,98</b>
<b>31504</b>	3/4" x 25 Ø	20	8435195802849	<b>4,52</b>
<b>31505</b>	1" x 32 Ø	15	8435195802856	<b>6,27</b>
<b>31506</b>	1 1/4" x 40 Ø	8	8435195802863	<b>10,49</b>
<b>31507</b>	1 1/2" x 50 Ø	10	8435195802870	<b>16,60</b>
<b>31508</b>	2" x 63 Ø	6	8435195802887	<b>25,66</b>

### RACOR RECTO UNIÓN TUBO A TUBO anillo de nylon

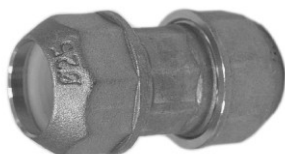

Código	Medida	Caja	Código Barras	€ / Ud.
<b>33003</b>	20 x 20 Ø	25	8435195802986	<b>4,89</b>
<b>33004</b>	25 x 25 Ø	15	8435195802993	<b>6,56</b>
<b>33005</b>	32 x 32 Ø	10	8435195803006	<b>10,27</b>
<b>33007</b>	50 x 50 Ø	6	8435195803020	<b>24,70</b>
<b>33008</b>	63 x 63 Ø	4	8435195803037	<b>37,95</b>

### RACOR CODO HEMBRA A TUBO anillo de nylon



Código	Medida	Caja	Código Barras	€ / Ud.
<b>37503</b>	1/2" x 20 Ø	30	8435195803419	<b>4,06</b>
<b>37504</b>	3/4" x 25 Ø	18	8435195803426	<b>5,95</b>
<b>37506</b>	1 1/4" x 40 Ø	5	8435195803440	<b>15,68</b>
<b>37507</b>	1 1/2" x 50 Ø	6	8435195803457	<b>23,98</b>
<b>37508</b>	2" x 63 Ø	4	8435195803464	<b>43,27</b>

### RACOR CODO MACHO A TUBO anillo de nylon



Código	Medida	Caja	Código Barras	€ / Ud.
<b>36003</b>	1/2" x 20 Ø	30	8435195803273	<b>4,22</b>
<b>36004</b>	3/4" x 25 Ø	18	8435195803280	<b>6,33</b>
<b>36005</b>	1" x 32 Ø	10	8435195803297	<b>10,47</b>
<b>36006</b>	1 1/4" x 40 Ø	5	8435195803303	<b>16,26</b>
<b>36007</b>	1 1/2" x 50 Ø	6	8435195803310	<b>24,20</b>
<b>36008</b>	2" x 63 Ø	4	8435195803327	<b>44,80</b>

## ACCESORIOS TUBO POLIETILENO

Anillo de nylon



### RACOR CODO UNIÓN TUBO A TUBO anillo de nylon



Código	Medida	Caja	Código Barras	€ / Ud.
<b>34503</b>	20 x 20 Ø	20	8435195803136	<b>5,99</b>
<b>34504</b>	25 x 25 Ø	10	8435195803143	<b>8,99</b>
<b>34505</b>	32 x 32 Ø	8	8435195803150	<b>13,40</b>
<b>34506</b>	40 x 40 Ø	3	8435195803167	<b>19,69</b>
<b>34508</b>	63 x 63 Ø	3	8435195803181	<b>53,73</b>

### RACOR CODO PLACA HEMBRA A TUBO anillo de nylon



Código	Medida	Caja	Código Barras	€ / Ud.
<b>37525</b>	1/2" x 20 Ø	20	8435195826760	<b>5,49</b>
<b>37526</b>	3/4" x 25 Ø	8	8435195826777	<b>7,83</b>

### RACOR TE HEMBRA A TUBO anillo de nylon



Código	Medida	Caja	Código Barras	€ / Ud.
<b>38003</b>	1/2" x 20 Ø	18	8435195803594	<b>5,66</b>
<b>38004</b>	3/4" x 25 Ø	10	8435195803600	<b>8,90</b>
<b>38006</b>	1 1/4" x 40 Ø	4	8435195803624	<b>20,22</b>
<b>38007</b>	1 1/2" x 50 Ø	4	8435195803648	<b>31,64</b>
<b>38008</b>	2" x 63 Ø	2	8435195803655	<b>59,98</b>

### RACOR TE UNIÓN TUBO A TUBO anillo de nylon



Código	Medida	Caja	Código Barras	€ / Ud.
<b>39003</b>	20 x 20 x 20 Ø	12	8435195803808	<b>7,90</b>
<b>39004</b>	25 x 25 x 25 Ø	8	8435195803815	<b>11,46</b>
<b>39005</b>	32 x 32 x 32 Ø	4	8435195803822	<b>15,81</b>
<b>39006</b>	40 x 40 x 40 Ø	3	8435195803839	<b>23,55</b>
<b>39007</b>	50 x 50 x 50 Ø	3	8435195803846	<b>42,51</b>
<b>39008</b>	63 x 63 x 63 Ø	2	8435195803853	<b>69,22</b>



## ACCESORIOS TUBO POLIETILENO

Anillo de latón

### RACOR RECTO HEMBRA A TUBO anillo de latón



Código	Medida	Caja	Código Barras	€ / Ud.
<b>30013</b>	1/2" x 20 Ø	40	8435195802771	<b>2,99</b>
<b>30014</b>	3/4" x 25 Ø	20	8435195802788	<b>4,36</b>
<b>30015</b>	1" x 32 Ø	15	8435195802795	<b>6,71</b>
<b>30016</b>	1 1/4" x 40 Ø	8	8435195802801	<b>11,16</b>
<b>30017</b>	1 1/2" x 50 Ø	10	8435195802818	<b>16,51</b>
<b>30018</b>	2" x 63 Ø	6	8435195802825	<b>24,86</b>

### RACOR RECTO MACHO A TUBO anillo de latón



Código	Medida	Caja	Código Barras	€ / Ud.
<b>31513</b>	1/2" x 20 Ø	40	8435195802924	<b>2,94</b>
<b>31514</b>	3/4" x 25 Ø	20	8435195802931	<b>4,09</b>
<b>31515</b>	1" x 32 Ø	15	8435195802948	<b>6,56</b>
<b>31516</b>	1 1/4" x 40 Ø	8	8435195802955	<b>10,43</b>
<b>31517</b>	1 1/2" x 50 Ø	10	8435195802962	<b>15,64</b>
<b>31518</b>	2" x 63 Ø	6	8435195802979	<b>23,21</b>

### RACOR RECTO UNIÓN TUBO A TUBO anillo de latón

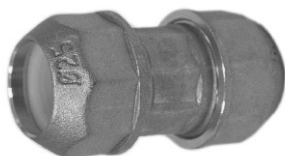

Código	Medida	Caja	Código Barras	€ / Ud.
<b>33013</b>	20 x 20 Ø	25	8435195803075	<b>4,81</b>
<b>33014</b>	25 x 25 Ø	15	8435195803082	<b>6,98</b>
<b>33015</b>	32 x 32 Ø	10	8435195803099	<b>10,69</b>
<b>33016</b>	40 x 40 Ø	5	8435195803105	<b>15,98</b>
<b>33017</b>	50 x 50 Ø	6	8435195803112	<b>24,23</b>
<b>33018</b>	63 x 63 Ø	4	8435195803129	<b>37,72</b>

### RACOR CODO HEMBRA A TUBO anillo de latón



Código	Medida	Caja	Código Barras	€ / Ud.
<b>37513</b>	1/2" x 20 Ø	30	8435195803501	<b>3,96</b>
<b>37514</b>	3/4" x 25 Ø	18	8435195803518	<b>5,46</b>
<b>37515</b>	1" x 32 Ø	10	8435195803525	<b>9,30</b>
<b>37516</b>	1 1/4" x 40 Ø	5	8435195803532	<b>16,42</b>
<b>37517</b>	1 1/2" x 50 Ø	6	8435195803549	<b>24,24</b>
<b>37518</b>	2" x 63 Ø	4	8435195803556	<b>41,80</b>

### RACOR CODO MACHO A TUBO anillo de latón



Código	Medida	Caja	Código Barras	€ / Ud.
<b>36013</b>	1/2" x 20 Ø	30	8435195803358	<b>3,66</b>
<b>36014</b>	3/4" x 25 Ø	18	8435195803365	<b>5,31</b>
<b>36015</b>	1" x 32 Ø	10	8435195803372	<b>9,29</b>
<b>36016</b>	1 1/4" x 40 Ø	5	8435195803389	<b>14,99</b>
<b>36017</b>	1 1/2" x 50 Ø	6	8435195803396	<b>23,92</b>
<b>36018</b>	2" x 63 Ø	4	8435195803402	<b>45,32</b>



## ACCESORIOS TUBO POLIETILENO

Anillo de latón

### RACOR CODO UNIÓN TUBO A TUBO anillo de latón



Código	Medida	Caja	Código Barras	€ / Ud.
<b>34513</b>	20 x 20 Ø	20	8435195803211	<b>5,77</b>
<b>34514</b>	25 x 25 Ø	10	8435195803228	<b>8,04</b>
<b>34515</b>	32 x 32 Ø	8	8435195803235	<b>12,93</b>
<b>34516</b>	40 x 40 Ø	3	8435195803242	<b>20,71</b>
<b>34517</b>	50 x 50 Ø	5	8435195803259	<b>31,28</b>
<b>34518</b>	63 x 63 Ø	3	8435195803266	<b>51,99</b>

### RACOR CODO PLACA HEMBRA A TUBO anillo de latón



Código	Medida	Caja	Código Barras	€ / Ud.
<b>37519</b>	1/2" x 20 Ø	20	8435195803563	<b>4,99</b>
<b>37520</b>	3/4" x 25 Ø	12	8435195803570	<b>7,66</b>
<b>37521</b>	1" x 32 Ø	8	8435195803587	<b>13,69</b>

### RACOR TE HEMBRA A TUBO anillo de latón



Código	Medida	Caja	Código Barras	€ / Ud.
<b>38013</b>	1/2" x 20 Ø	18	8435195803686	<b>5,99</b>
<b>38014</b>	3/4" x 25 Ø	10	8435195803693	<b>8,76</b>
<b>38015</b>	1" x 32 Ø	6	8435195803709	<b>15,25</b>
<b>38016</b>	1 1/4" x 40 Ø	4	8435195803716	<b>21,80</b>
<b>38017</b>	1 1/2" x 50 Ø	4	8435195803723	<b>34,55</b>
<b>38018</b>	2" x 63 Ø	2	8435195803730	<b>58,77</b>

### RACOR TE UNIÓN TUBO A TUBO anillo de latón



Código	Medida	Caja	Código Barras	€ / Ud.
<b>39013</b>	20 x 20 x 20 Ø	12	8435195803884	<b>7,79</b>
<b>39014</b>	25 x 25 x 25 Ø	8	8435195803891	<b>11,23</b>
<b>39015</b>	32 x 32 x 32 Ø	4	8435195803907	<b>17,45</b>
<b>39016</b>	40 x 40 x 40 Ø	3	8435195803914	<b>27,81</b>
<b>39017</b>	50 x 50 x 50 Ø	3	8435195803921	<b>43,99</b>
<b>39018</b>	63 x 63 x 63 Ø	2	8435195803938	<b>66,79</b>



## ACCESORIOS TUBO POLIETILENO

Anillo de acero inoxidable con bridas

### RACOR RECTO HEMBRA A TUBO anillo de acero inox. con bridas



Código	Medida	Caja	Código Barras	€ / Ud.
<b>30009</b>	2 1/2" x 75 Ø	4	8435195802740	<b>72,82</b>
<b>30010</b>	3" x 90 Ø	2	8435195802757	<b>105,28</b>
<b>30011</b>	4" x 110 Ø	2	8435195802764	<b>217,73</b>

### RACOR RECTO MACHO A TUBO anillo de acero inox. con bridas



Código	Medida	Caja	Código Barras	€ / Ud.
<b>31509</b>	2 1/2" x 75 Ø	4	8435195802894	<b>73,55</b>
<b>31510</b>	3" x 90 Ø	2	8435195802900	<b>102,62</b>
<b>31511</b>	4" x 110 Ø	2	8435195802917	<b>199,60</b>

### RACOR RECTO UNIÓN TUBO A TUBO anillo de acero inox. con bridas

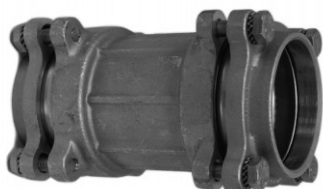

Código	Medida	Caja	Código Barras	€ / Ud.
<b>33009</b>	75 x 75 Ø	4	8435195803044	<b>122,44</b>
<b>33010</b>	90 x 90 Ø	2	8435195803051	<b>177,60</b>
<b>33011</b>	110 x 110 Ø	1	8435195803068	<b>399,50</b>

### RACOR CODO HEMBRA A TUBO anillo de acero inox. con bridas



Código	Medida	Caja	Código Barras	€ / Ud.
<b>37509</b>	2 1/2" x 75 Ø	2	8435195803471	<b>106,06</b>
<b>37510</b>	3" x 90 Ø	2	8435195803488	<b>167,64</b>
<b>37511</b>	4" x 110 Ø	2	8435195803495	<b>336,60</b>

### RACOR CODO MACHO A TUBO anillo de acero inox. con bridas



Código	Medida	Caja	Código Barras	€ / Ud.
<b>36009</b>	2 1/2" x 75 Ø	2	8435195803334	<b>107,74</b>
<b>36010</b>	3" x 90 Ø	2	8435195803341	<b>160,24</b>



## ACCESORIOS TUBO POLIETILENO

Anillo de acero inoxidable con bridas

### RACOR CODO UNIÓN TUBO A TUBO anillo de acero inox. con bridas



Código	Medida	Caja	Código Barras	€ / Ud.
<b>34509</b>	75 x 75 Ø	2	8435195803198	<b>151,64</b>
<b>34510</b>	90 x 90 Ø	2	8435195803204	<b>221,98</b>

### RACOR TE HEMBRA A TUBO anillo de acero inox. con bridas



Código	Medida	Caja	Código Barras	€ / Ud.
<b>38009</b>	2 1/2" x 75 Ø	1	8435195803662	<b>168,62</b>
<b>38010</b>	3" x 90 Ø	1	8435195803679	<b>254,47</b>
<b>38011</b>	4" x 110 Ø	1	8435195803686	<b>525,67</b>

### RACOR TE UNIÓN TUBO A TUBO anillo de acero inox. con bridas



Código	Medida	Caja	Código Barras	€ / Ud.
<b>39009</b>	75 x 75 x 75 Ø	1	8435195803860	<b>217,70</b>
<b>39010</b>	90 x 90 x 90 Ø	1	8435195803877	<b>318,47</b>

# ACCESORIOS TUBO POLIETILENO

Recambios



## ANILLO ABIERTO NYLON



Código	Medida	Caja	Código Barras	€ / Ud.
<b>39025</b>	20 Ø	10	8435195820645	<b>0,14</b>
<b>39026</b>	25 Ø	10	8435195820652	<b>0,18</b>
<b>39027</b>	32 Ø	10	8435195820669	<b>0,21</b>
<b>39028</b>	40 Ø	10	8435195820676	<b>0,32</b>
<b>39029</b>	50 Ø	10	8435195820683	<b>0,39</b>
<b>39030</b>	63 Ø	10	8435195820690	<b>0,61</b>

## ARANDELA NYLON



Código	Medida	Caja	Código Barras	€ / Ud.
<b>39060</b>	20 Ø	10	8435195820845	<b>0,12</b>
<b>39061</b>	25 Ø	10	8435195820852	<b>0,16</b>
<b>39062</b>	32 Ø	10	8435195820869	<b>0,17</b>
<b>39063</b>	40 Ø	10	8435195820876	<b>0,28</b>
<b>39064</b>	50 Ø	10	8435195820883	<b>0,32</b>
<b>39065</b>	63 Ø	10	8435195820890	<b>0,60</b>

## ANILLO ABIERTO LATÓN



Código	Medida	Caja	Código Barras	€ / Ud.
<b>39019</b>	20 Ø	10	8435195820584	<b>0,77</b>
<b>39020</b>	25 Ø	10	8435195820591	<b>0,87</b>
<b>39021</b>	32 Ø	10	8435195820607	<b>1,35</b>
<b>39022</b>	40 Ø	10	8435195820614	<b>1,77</b>
<b>39023</b>	50 Ø	10	8435195820621	<b>2,75</b>
<b>39024</b>	63 Ø	10	8435195820638	<b>4,19</b>

## ARANDELA LATÓN



Código	Medida	Caja	Código Barras	€ / Ud.
<b>39050</b>	20 Ø	10	8435195820784	<b>0,48</b>
<b>39051</b>	25 Ø	10	8435195820791	<b>0,58</b>
<b>39052</b>	32 Ø	10	8435195820807	<b>0,67</b>
<b>39053</b>	40 Ø	10	8435195820814	<b>1,26</b>
<b>39054</b>	50 Ø	10	8435195820821	<b>1,75</b>
<b>39055</b>	63 Ø	10	8435195820838	<b>3,08</b>

## JUNTA TÓRICA

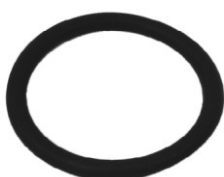



Código	Medida	Caja	Código Barras	€ / Ud.
<b>39031</b>	20 Ø	10	8435195820706	<b>0,10</b>
<b>39032</b>	25 Ø	10	8435195820713	<b>0,15</b>
<b>39033</b>	32 Ø	10	8435195820720	<b>0,15</b>
<b>39034</b>	40 Ø	10	8435195820737	<b>0,36</b>
<b>39035</b>	50 Ø	10	8435195820744	<b>0,56</b>
<b>39036</b>	63 Ø	10	8435195820751	<b>0,80</b>





## GRIFOS FLOTADORES Y BOYAS

<b>Flotadores</b>		<b>152</b>
<b>Boyas</b>		<b>152</b>
<b>Accesorios</b>		<b>156</b>

## GRIFOS FLOTADORES Y BOYAS



### GRIFO FLOTADOR CAZOLETA



Código	Medida	Caja	Código Barras	€ / Ud.
<b>57501</b>	3/8"	100	8435195808025	<b>3,59</b>
<b>57502</b>	1/2"	50	8435195808032	<b>6,49</b>

Recambio	Código	Descripción	Código Barras	€ / Ud.
	<b>58517</b>	Varilla 220 mm. Rosca 3/16	8435195820348	<b>0,80</b>

### GRIFO FLOTADOR GUÍA VARILLA REDONDA



Código	Medida		Caja	Código Barras	€ / Ud.
<b>58002</b>	3/8"	3/16 inox.	25	8435195832990	<b>6,25</b>
<b>58003</b>	1/2"	6/100	25	8435195808049	<b>7,76</b>
<b>58004</b>	3/4"	6/100	25	8435195808056	<b>11,25</b>
<b>58005</b>	1"	8/100	25	8435195808063	<b>14,70</b>
<b>58006</b>	1 1/4"	9/100	10	8435195808070	<b>32,88</b>
<b>58007</b>	1 1/2"	9/100	10	8435195808087	<b>39,98</b>
<b>58008</b>	2"	9/100	5	8435195808094	<b>62,70</b>

### GRIFO FLOTADOR ACERO INOX. CIERRE SILICONA



Código	Medida		Caja	Código Barras	€ / Ud.
<b>58040</b>	3/8"	6/100	1	8435195840865	<b>20,75</b>
<b>58041</b>	1/2"	6/100	1	8435195833003	<b>21,58</b>
<b>58042</b>	3/4"	8/100	1	8435195833010	<b>36,92</b>
<b>58043</b>	1"	8/100	1	8435195833027	<b>38,99</b>
<b>58044</b>	1 1/4"	8/100	1	8435195833034	<b>45,16</b>

- Fabricado en acero inoxidable AISI 304.
- Conexión rosca gas.
- Presión máxima de trabajo 10 Kg/cm.
- Cierre de silicona.
- Paso total.

### GRIFO FLOTADOR GUÍA VARILLA ARTICULADA



Código	Medida		Caja	Código Barras	€ / Ud.
<b>58016</b>	1/2"	6/100	25	8435195808131	<b>7,96</b>
<b>58017</b>	3/4"	6/100	25	8435195808148	<b>11,25</b>
<b>58018</b>	1"	8/100	25	8435195808155	<b>15,98</b>

### GRIFO FLOTADOR GUÍA VARILLA DESLIZANTE

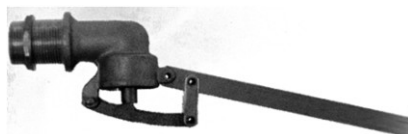

Código	Medida		Caja	Código Barras	€ / Ud.
<b>58019</b>	1/2"		25	8435195808162	<b>9,33</b>
<b>58020</b>	3/4"		25	8435195808179	<b>10,68</b>
<b>58021</b>	1"		25	8435195808186	<b>14,87</b>
<b>58022</b>	1 1/4"		10	8435195808193	<b>41,28</b>
<b>58023</b>	1 1/2"		10	8435195808209	<b>54,74</b>
<b>58024</b>	2"		5	8435195808216	<b>72,28</b>
<b>58025</b>	2 1/2"		1	8435195808355	<b>253,35</b>
<b>58026</b>	3"		1	8435195808362	<b>294,90</b>

## GRIFOS FLOTADORES Y BOYAS



### GRIFO FLOTADOR SILENCIOSO MACHO

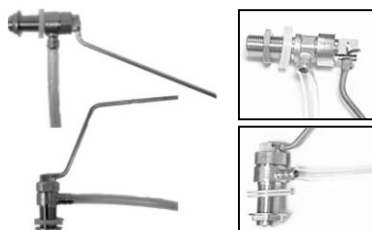

Código	Medida		Caja	Código Barras	€ / Ud.
<b>57001</b>	M 3/8"	Tanque alto	100	8435195808025	<b>3,58</b>
<b>57002</b>	M 3/8"	Tanque bajo	50	8435195808032	<b>3,58</b>

- Fabricado en latón niquelado.

### GRIFO FLOTADOR SILENCIOSO HEMBRA

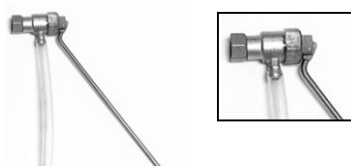

Código	Medida		Caja	Código Barras	€ / Ud.
<b>57003</b>	H 3/8"	Tanque alto	50	8435195808032	<b>3,90</b>

- Fabricado en latón niquelado.

### GRIFO FLOTADOR TELESCÓPICO VERTICAL CON BOYA



Código	Medida		Caja	Código Barras	€ / Ud.
<b>57011</b>	M 3/8"	Tanque bajo	10	8435195807998	<b>4,99</b>

- Altura regulable.
- Con boya de plástico.

### GRIFO FLOTADOR TELESCÓPICO LATERAL CON BOYA



Código	Medida		Caja	Código Barras	€ / Ud.
<b>57007</b>	M 3/8"	Tanque bajo	10	8435195807981	<b>5,10</b>

- Altura regulable.
- Con boya de plástico.

### GRIFO FLOTADOR VERTICAL



Código	Medida		Caja	Código Barras	€ / Ud.
<b>57013</b>	M 3/8"		10	8435195808001	<b>8,96</b>

- Entrada toma baja rosca M 3/8" de latón.
- Altura regulable.
- Con boya integrada.

### GRIFO FLOTADOR LATERAL



Código	Medida		Caja	Código Barras	€ / Ud.
<b>57014</b>	M 3/8"		10	8435195808018	<b>8,96</b>

- Entrada toma baja rosca M 3/8" de latón.
- Altura regulable.
- Con boya integrada.

## GRIFOS FLOTADORES Y BOYAS



### BOYA DE POREXPAN CILÍNDRICA CON SOPORTE GUÍA



Código	Medida			Caja	Código Barras	€ / Ud.
<b>58500</b>	3/8"	3/16.	70 x 80 Ø	40	8435195808223	<b>0,99</b>

- Para grifo flotador cazoleta.
- Para grifo flotador silencioso.

### BOYA DE POREXPAN ESFÉRICA



Código	Medida			Caja	Código Barras	€ / Ud.
<b>58501</b>	3/8"	3/16.	90 Ø	200	8435195808230	<b>0,68</b>
<b>58502</b>	1/2"	3/16.	110 Ø	80	8435195808247	<b>1,09</b>
<b>58516</b>	1/2"	6/100	110 Ø	80	8435195808254	<b>1,54</b>
<b>58519</b>	3/4"	6/100	130 Ø	10	8435195808906	<b>1,86</b>

- Para grifo flotador cazoleta.
- Para grifo flotador silencioso.

### BOYA DE PLÁSTICO ESFÉRICA



Código	Medida			Caja	Código Barras	€ / Ud.
<b>58508</b>	3/8"	3/16.	90 Ø	220	8435195808261	<b>0,82</b>
<b>58534</b>	3/8"	6/100	90 Ø	220	8435195840964	<b>0,92</b>
<b>58537</b>	1/2"	3/16.	110 Ø	120	8435195840988	<b>1,79</b>
<b>58503</b>	1/2"	6/100	110 Ø	120	8435195808278	<b>1,69</b>
<b>58504</b>	3/4"	6/100	130 Ø	66	8435195808285	<b>2,06</b>
<b>58538</b>	3/4"	7/100	130 Ø	66	8435195840995	<b>2,25</b>
<b>58539</b>	1"	6/100	150 Ø	26	8435195841008	<b>2,99</b>
<b>58505</b>	1"	8/100	150 Ø	26	8435195808292	<b>2,73</b>
<b>58506</b>	1 1/4"	9/100	200 Ø	18	8435195808308	<b>4,15</b>
<b>58507</b>	2"	9/100	230 Ø	12	8435195808315	<b>5,89</b>

- Para grifo flotador guía varilla redonda.

### BOYA DE PLÁSTICO PLANA



Código	Medida		Caja	Código Barras	€ / Ud.
<b>58530</b>	1/2" y 3/4"	120 Ø	66	8435195821314	<b>4,49</b>
<b>58531</b>	1"	150 Ø	26	8435195821321	<b>5,33</b>
<b>58532</b>	1 1/4", 1 1/2" y 2"	200 Ø	18	8435195821338	<b>7,75</b>
<b>58533</b>	2 1/2" y 3"	250 Ø	12	8435195821345	<b>9,98</b>

- Para grifo flotador guía varilla redonda y deslizante.

## GRIFOS FLOTADORES Y BOYAS

### BOYA DE COBRE PLANA



Código	Medida		Caja	Código Barras	€ / Ud.
<b>58509</b>	1/2"	120 Ø	25	8435195808339	<b>22,97</b>
<b>58510</b>	3/4"	150 Ø	25	8435195808346	<b>28,39</b>
<b>58511</b>	1"	170 Ø	25	8435195808353	<b>32,39</b>
<b>58512</b>	1 1/4"	200 Ø	10	8435195808360	<b>52,93</b>
<b>58513</b>	1 1/2"	230 Ø	10	8435195808377	<b>55,69</b>
<b>58514</b>	2"	250 Ø	5	8435195808384	<b>60,62</b>
<b>58515</b>	2 1/2"	280 Ø	2	8435195820287	<b>96,18</b>
<b>58518</b>	3"	300 Ø	2	8435195820294	<b>142,63</b>

- Para grifo flotador guía varilla redonda y deslizante.

### BOYA DE LATÓN ESFÉRICA



Código	Medida		Caja	Código Barras	€ / Ud.
<b>58526</b>	3/8"	90 Ø	10	8435195826913	<b>14,67</b>
<b>58520</b>	1/2"	110 Ø	25	8435195808391	<b>18,98</b>
<b>58521</b>	3/4"	130 Ø	25	8435195808407	<b>21,70</b>
<b>58522</b>	1"	150 Ø	25	8435195808414	<b>26,98</b>
<b>58523</b>	1 1/4"	180 Ø	10	8435195808421	<b>46,30</b>
<b>58524</b>	1 1/2"	200 Ø	10	8435195808438	<b>48,71</b>
<b>58525</b>	2"	230 Ø	5	8435195808445	<b>56,63</b>

- Para grifo flotador guía varilla redonda.

### BOYA DE ACERO INOXIDABLE ESFÉRICA



Código	Medida		Caja	Código Barras	€ / Ud.
<b>58546</b>	3/8"	90 Ø	1	8435195841053	<b>17,96</b>
<b>58544</b>	1/2"	110 Ø	1	8435195833041	<b>22,96</b>
<b>58545</b>	3/4"	160 Ø	1	8435195833058	<b>47,53</b>

- Para grifo flotador guía varilla redonda.



## GRIFOS FLOTADORES Y BOYAS

Accesorios

### JUNTA MEMBRANA FLOTADOR



Código	Medida	Caja	Código Barras	€ / Ud.
<b>57016</b>	3/8" x 18,50	25	8435195833065	<b>0,25</b>
<b>57017</b>	3/8" x 24	25	8435195833850	<b>0,29</b>

### TUERCA ABS CON HEXÁGONO



Código	Medida	Caja	Código Barras	€ / Ud.
<b>57020</b>	3/8"	25	8435195833072	<b>0,20</b>
<b>57021</b>	1/2"	25	8435195833843	<b>0,24</b>

- ABS blanco.

### JUNTA CIERRE TAZA TANQUE ESPECIAL



Código	Medida	Caja	Código Barras	€ / Ud.
<b>72051</b>	110 x 72 mm.	25	8435195833089	<b>1,28</b>

- Goma material espumoso.

### JUNTA CIERRE TAZA TANQUE CISTERNA BAJA



Código	Medida	Caja	Código Barras	€ / Ud.
<b>72050</b>	97 x 57 mm.	25	8435195826920	<b>1,28</b>

- Caucho.



## CISTERNA E INODORO

<b>Descargadores y gomas</b>		<b>158</b>
<b>Cisterna y accesorios</b>		<b>161</b>
<b>Tiradores</b>		<b>162</b>
<b>Gomas y juntas</b>		<b>163</b>
<b>Manguitos y tapones</b>		<b>164</b>
<b>Tapas inodoro</b>		<b>166</b>
<b>Accesorios de baño</b>		<b>167</b>

## DESCARGADOR CISTERNA TANQUE ALTO



Código	Descripción	Caja	Código Barras	€ / Ud.
72001	PVC	10	8435195811711	3,27

## CAMPANA DESCARGADOR CISTERNA TANQUE ALTO



Código	Descripción	Caja	Código Barras	€ / Ud.
72002	PVC	10	8435195811728	2,99

## REBOSADERO CON TOPE DESCARGADOR TANQUE ALTO



Código	Descripción	Caja	Código Barras	€ / Ud.
72003	PVC	10	8435195811735	0,40

## GOMA OBTURADORA DESCARGADOR TANQUE ALTO



Código	Medida	Caja	Código Barras	€ / Ud.
72004	5 x 45 mm.	5	8435195811742	0,50

## GOMA OBTURADORA DESCARGADOR TANQUE ALTO



Código	Medida	Caja	Código Barras	€ / Ud.
72046	7 x 45 mm.	10	8435195842333	0,55

## GANCHILLO DESCARGADOR TANQUE ALTO



Código	Descripción	Caja	Código Barras	€ / Ud.
72005	Acero Inox.	10	8435195811759	0,35

## GOMA CÓNICA BAJANTE CISTERNA TANQUE ALTO



Código	Medida	Caja	Código Barras	€ / Ud.
72012	1 1/4" x 32 mm.	10	8435195811759	0,35



## CISTERNA E INODORO



### DESCARGADOR CISTERNA TANQUE BAJO REGULABLE



Código	Descripción	Caja	Código Barras	€ / Ud.
<b>72006</b>	PVC	10	8435195811773	<b>4,29</b>

- Rosca universal tipo Roca.

### CAMPANA DESCARGADOR CISTERNA TANQUE BAJO REGULABLE



Código	Descripción	Caja	Código Barras	€ / Ud.
<b>72007</b>	PVC	10	8435195811780	<b>3,63</b>

### GOMA OBTURADORA DESCARGADOR TANQUE BAJO



Código	Medida	Caja	Código Barras	€ / Ud.
<b>72008</b>	17 x 60 mm.	100	8435195811797	<b>0,68</b>

### GOMA OBTURADORA DESCARGADOR TANQUE BAJO



Código	Medida	Caja	Código Barras	€ / Ud.
<b>72009</b>	23 x 73	100	8435195811803	<b>0,90</b>

- Tipo Roca.

### GOMA ASIENTO ROCA SILICONA TANQUE BAJO



Código	Medida	Caja	Código Barras	€ / Ud.
<b>72010</b>	75 x 50 mm.	100	8435195811810	<b>0,62</b>

### BASE CON TUERCA DESCARGADOR CISTERNA TANQUE BAJO

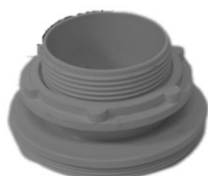

Código	Descripción	Caja	Código Barras	€ / Ud.
<b>72011</b>	PVC	10	8435195811827	<b>2,49</b>

### JUNTA CIERRE TAZA TANQUE CISTERNA BAJA



Código	Medida	Caja	Código Barras	€ / Ud.
<b>72050</b>	97 x 57 mm.	25	8435195826920	<b>1,28</b>

### JUNTA CIERRE TAZA TANQUE CISTERNA BAJA ESPECIAL



Código	Medida	Caja	Código Barras	€ / Ud.
<b>72051</b>	110 x 72 mm.	25	8435195833089	<b>1,28</b>

## DESCARGADOR CISTERNA DE PULSADOR SIMPLE



Código	Descripción	Caja	Código Barras	€ / Ud.
<b>72039</b>	PVC	1	8435195833096	<b>15,96</b>

- Compatible con el sistema Roca. (Tradicional de rosca)
- Fabricados con materiales plásticos de alta calidad y anticalcáreos.

## DESCARGADOR CISTERNA DE PULSADOR ININTERRUMPLIBLE



Código	Descripción	Caja	Código Barras	€ / Ud.
<b>72044</b>	PVC	1	8435195833126	<b>17,57</b>

- Compatible con el sistema Roca. (Tradicional de rosca)
- Fabricados con materiales plásticos de alta calidad y anticalcáreos.

	Código	Descripción	Código Barras	€ / Ud.
<b>Recambio</b>	<b>72045</b>	Goma obturadora	8435195842326	<b>1,34</b>
	<b>72052</b>	Pulsador	8435195842371	<b>3,94</b>

## DESCARGADOR CISTERNA DE DOBLE PULSADOR ORIENTABLE



Código	Descripción	Caja	Código Barras	€ / Ud.
<b>72042</b>	PVC	1	8435195833119	<b>17,57</b>

- Compatible con el sistema Roca. (Tradicional de rosca)
- Fabricados con materiales plásticos de alta calidad y anticalcáreos.
- Pulsador de accionamiento remoto (cable de acero) que puede ser ubicado en cualquier lado del tanque.
- Doble descarga, ambas regulables. (Descarga media y descarga total).
- Pulsador preparado para agujeros de cualquier dimensión.

	Código	Descripción	Código Barras	€ / Ud.
<b>Recambio</b>	<b>72047</b>	Goma obturadora	8435195842340	<b>1,28</b>
	<b>72049</b>	Pulsador	8435195842364	<b>4,16</b>

## DESCARGADOR CISTERNA DE DOBLE PULSADOR UNIVERSAL



Código	Descripción	Caja	Código Barras	€ / Ud.
<b>72041</b>	PVC	1	8435195833102	<b>17,57</b>

- Compatible con el sistema Roca. (Tradicional de rosca)
- Fabricados con materiales plásticos de alta calidad y anticalcáreos.
- Doble descarga, ambas regulables. (Descarga media y descarga total).

	Código	Descripción	Código Barras	€ / Ud.
<b>Recambio</b>	<b>72047</b>	Goma obturadora	8435195842340	<b>1,28</b>
	<b>72048</b>	Pulsador	8435195842357	<b>3,59</b>

## DESCARGADOR CISTERNA DE DOBLE PULSADOR UNIVERSAL



Código	Descripción	Caja	Código Barras	€ / Ud.
<b>72043</b>	PVC	1	8435195842319	<b>7,98</b>

- Fabricados con materiales plásticos de alta calidad y anticalcáreos.
- Regulable en altura.
- Doble descarga, ambas regulables. (Descarga media y descarga total).



## CISTERNA E INODORO

### CASCO CISTERNA TANQUE ALTO



Código	Descripción	Caja	Código Barras	€ / Ud.
<b>72015</b>	ABS blanco	24	8435195811889	<b>5,21</b>

### BAJANTE CISTERNA TANQUE ALTO



Código	Descripción	Caja	Código Barras	€ / Ud.
<b>72020</b>	ABS blanco	10	8435195801972	<b>6,46</b>

### CONJUNTO ACCESORIOS CISTERNA TANQUE ALTO



Código	Descripción	Caja	Código Barras	€ / Ud.
<b>72016</b>	Conjunto completo	10	8435195811896	<b>8,98</b>

• Contiene: descargador tanque alto, grifo flotador cazoleta 3/8, boya de espuma, palanca descargador, tirador tanque alto con pomo y juego tornillos palanca.

### PALANCA DESCARGADOR CISTERNA ALTA



Código	Descripción	Caja	Código Barras	€ / Ud.
<b>72013</b>	ABS	100	8435195811858	<b>0,56</b>



Código	Descripción	Caja	Código Barras	€ / Ud.
<b>72014</b>	Acero	200	8435195811865	<b>0,86</b>



Código	Descripción	Caja	Código Barras	€ / Ud.
<b>72017</b>	Acero con soporte de latón	150	8435195811872	<b>2,53</b>

### JUEGO DOS TORNILLOS SOPORTE PALANCA



Código	Medida	Caja	Código Barras	€ / Ud.
<b>72018</b>	M5 x 35 mm.	100	8435195811902	<b>0,43</b>

## CISTERNA E INODORO



### TIRADOR CISTERNA TANQUE ALTO CLÁSICO



Código	Descripción	Caja	Código Barras	€ / Ud.
<b>72022</b>	ABS blanco	25	8435195811926	<b>1,15</b>

### TIRADOR CISTERNA TANQUE ALTO PLANO



Código	Descripción	Caja	Código Barras	€ / Ud.
<b>72021</b>	ABS blanco	25	8435195811919	<b>0,98</b>

### TIRADOR CISTERNA TANQUE ALTO BOMBILLA



Código	Descripción	Caja	Código Barras	€ / Ud.
<b>72023</b>	Cristal	25	8435195811933	<b>1,85</b>
<b>72024</b>	ABS fumé	25	8435195811940	<b>1,85</b>

### TIRADOR CISTERNA TANQUE ALTO ANILLA



Código	Descripción	Caja	Código Barras	€ / Ud.
<b>72038</b>	ABS Blanco	25	8435195847673	<b>1,98</b>

### TIRADOR CISTERNA TANQUE BAJO ABS



Código	Descripción	Caja	Código Barras	€ / Ud.
<b>72025</b>	Recto	25	8435195811964	<b>1,58</b>
<b>72027</b>	Curvo	25	8435195811988	<b>1,58</b>

### TIRADOR CISTERNA TANQUE BAJO METAL



Código	Descripción	Caja	Código Barras	€ / Ud.
<b>72026</b>	Recto	25	8435195811971	<b>2,35</b>
<b>72028</b>	Curvo	25	8435195811995	<b>2,35</b>

## CISTERNA E INODORO



### GOMA OBTURADORA TIPO ROCA ANTIGUA



Código	Medida	Caja	Código Barras	€ / Ud.
<b>72030</b>	70 x 23 x 3 mm.	50	8435195812008	<b>0,43</b>

### GOMA OBTURADORA TIPO ROCA NUEVA



Código	Medida	Caja	Código Barras	€ / Ud.
<b>72031</b>	68 x 33 x 3 mm.	50	8435195812015	<b>0,39</b>

### DISCO FLOTADOR TIPO ROCA



Código	Medida	Caja	Código Barras	€ / Ud.
<b>72032</b>	29 x 3 mm.	50	8435195812022	<b>0,17</b>

### JUNTA SEMI PLANA FREGADERO



Código	Medida	Caja	Código Barras	€ / Ud.
<b>72033</b>	68 X 40 5,5 mm.	50	8435195812039	<b>0,52</b>

### JUNTA SEMI PLANA BAÑERA



Código	Medida	Caja	Código Barras	€ / Ud.
<b>72034</b>	79 x 45 x 6,5 mm.	50	8435195812046	<b>1,18</b>

# CISTERNA E INODORO

Manguitos WC



## MANGUITO FLEXIBLE LABIADO INODORO



	Código	Medida	Caja	Código Barras	€ / Ud.
<b>Recto</b>	<b>25543</b>	110 Ø	10	8435195828245	<b>2,60</b>



	Código	Medida	Caja	Código Barras	€ / Ud.
<b>Excéntrico</b>	<b>25544</b>	110 Ø	10	8435195828252	<b>2,60</b>

## MANGUITO INODORO COMPRIMIBLE



	Código	Medida	Caja	Código Barras	€ / Ud.
	<b>63516</b>	90 / 100 / 110 Ø x 400 mm.	18	8435195823660	<b>6,56</b>

## MANGUITO INODORO EXTENSIBLE



	Código	Medida	Caja	Código Barras	€ / Ud.
	<b>63505</b>	90 / 100 / 110 Ø x 250-530 mm.	25	8435195821369	<b>6,35</b>

## MANGUITO PVC PARA INODORO



	Código	Medida	Caja	Código Barras	€ / Ud.
<b>Recto</b>	<b>25546</b>	90 Ø	36	8435195820546	<b>3,87</b>



	Código	Medida	Caja	Código Barras	€ / Ud.
<b>Excéntrico</b>	<b>25545</b>	90 Ø	36	8435195820539	<b>3,87</b>
	<b>25547</b>	110 Ø	36	8435195824537	<b>3,87</b>

# CISTERNA E INODORO

Manguitos WC



## GOMA MANGUITO



	Código	Medida	Caja	Código Barras	€ / Ud.
<b>Superior</b>	<b>25548</b>	90 Ø	1	8435195827897	<b>1,62</b>



	Código	Medida	Caja	Código Barras	€ / Ud.
<b>Labiada</b>	<b>25549</b>	90 Ø	1	843519582703	<b>1,34</b>

## TAPÓN MACHO ABS



	Código	Medida	Caja	Código Barras	€ / Ud.
	<b>74007</b>	3/8"	100	8435195812251	<b>0,170</b>
	<b>74005</b>	1/2"	100	8435195812268	<b>0,099</b>
	<b>74006</b>	3/4"	50	8435195812275	<b>0,180</b>

## TAPÓN HEMBRA ABS



	Código	Medida	Caja	Código Barras	€ / Ud.
	<b>74008</b>	1/2"	250	8435195847697	<b>0,54</b>
	<b>74009</b>	3/4"	200	8435195847703	<b>0,63</b>
	<b>74001</b>	1"	150	8435195847680	<b>0,97</b>

# CISTERNA E INODORO



## TAPA INODORO UNIVERSAL

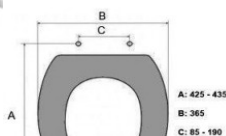

Código	Descripción	Caja	Código Barras	€ / Ud.
<b>98097</b>	PP	12	8435195801996	<b>10,98</b>

- Incluye juego de tornillos de fijación.
- Tapa de gran calidad, con diseño confortable, resistente y de fácil montaje.
- Con herraje regulable.
- Adaptable a la mayoría de inodoros comunes del mercado.

Recambio	Código	Descripción	Caja	Código Barras	€ / Ud.
	<b>99248</b>	Juego de tornillos	10	8435195822854	<b>3,93</b>

## TAPA INODORO CONTINENTAL

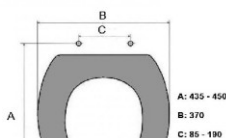

Código	Descripción	Caja	Código Barras	€ / Ud.
<b>98098</b>	PP	10	8435195812053	<b>21,12</b>

- Incluye juego de tornillos de fijación.
- Tapa de gran calidad, con diseño confortable, resistente y de fácil montaje.
- Con herraje de acero inoxidable y regulable.
- Adaptable a la mayoría de inodoros comunes del mercado.

Recambio	Código	Descripción	Caja	Código Barras	€ / Ud.
	<b>98099</b>	Juego de tornillos	10	8435195822861	<b>6,72</b>

## TAPA INODORO LUCIAN

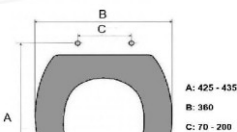

Código	Descripción	Caja	Código Barras	€ / Ud.
<b>98090</b>	ABS	10	8435195822878	<b>30,62</b>

- Incluye juego de tornillos de fijación.
- Tapa de gran calidad, con diseño confortable, resistente y de fácil montaje.
- Con herraje de acero inoxidable y regulable.
- Adaptable a la mayoría de inodoros comunes del mercado.

Recambio	Código	Descripción	Caja	Código Barras	€ / Ud.
	<b>98091</b>	Juego de tornillos	10	8435195822885	<b>6,72</b>





## CISTERNA E INODORO

### PORTAESCOBILLAS COMPLETO



Código	Descripción	Caja	Código Barras	€ / Ud.
<b>98093</b>	ABS	12	8435195822892	<b>4,61</b>

▪ Diponible en varios colores: blanco, beige, celeste y rosa.

### ESCOBILLA



Código	Descripción	Caja	Código Barras	€ / Ud.
<b>98094</b>	ABS	1	8435195822908	<b>2,49</b>

### TABURETE DE BAÑO



Código	Descripción	Caja	Código Barras	€ / Ud.
<b>98095</b>	ABS	1	8435195822915	<b>19,68</b>

▪ Diponible en varios colores: blanco, beige, celeste y rosa.

### EJE PORTARROLLOS

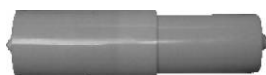

Código	Descripción	Caja	Código Barras	€ / Ud.
<b>72019</b>	ABS blanco	10	8435195826951	<b>0,65</b>





## ACCESORIOS DE FIJACIÓN

Accesorios de fijación



170

## ACCESORIOS DE FIJACIÓN



### JUEGO 2 TORNILLOS FIJACIÓN INODORO / BIDET ACERO INOX.



Código	Medida	Caja	Código Barras	€ / Ud.
<b>62001</b>	M5 x 75 mm.	50	8435195841411	<b>1,22</b>

### JUEGO 2 TORNILLOS FIJACIÓN INODORO / BIDET LATÓN



Código	Medida	Caja	Código Barras	€ / Ud.
<b>62003</b>	M5 x 75 mm.	50	8435195809534	<b>0,99</b>

### JUEGO 2 TORNILLOS FIJACIÓN INODORO / BIDET ACERO



Código	Medida	Caja	Código Barras	€ / Ud.
<b>62002</b>	M5 x 75 mm.	50	8435195809527	<b>0,45</b>

### JUEGO 4 TORNILLOS FIJACIÓN INODORO / BIDET ACERO



Código	Medida	Caja	Código Barras	€ / Ud.
<b>62010</b>	M5 x 75 mm.	25	8435195827873	<b>0,96</b>

### JUEGO 2 TORNILLOS FIJACIÓN LATERAL INODORO



Código	Medida	Caja	Código Barras	€ / Ud.
<b>99150</b>	M6	25	8435195809565	<b>1,19</b>

### JUEGO 2 TORNILLOS FIJACIÓN LATERAL INODORO CON EMBELLECEDOR



Código	Medida	Caja	Código Barras	€ / Ud.
<b>99151</b>	M6	25	8435195821352	<b>1,57</b>

### JUEGO 2 TORNILLOS FIJACIÓN INODORO CON SOPORTE NYLON



Código	Medida	Caja	Código Barras	€ / Ud.
<b>62015</b>	M6	25	8435195847710	<b>1,44</b>

## ACCESORIOS DE FIJACIÓN



### JUEGO 2 TORNILLOS FIJACIÓN LAVABO ACERO



Código	Medida	Caja	Código Barras	€ / Ud.
<b>62004</b>	M8 x 90 mm.	25	8435195809541	<b>0,69</b>
<b>62005</b>	M10 x 100 mm.	25	8435195809558	<b>0,88</b>

### JUEGO 2 TORNILLOS FIJACIÓN LAVABO NYLON



Código	Medida	Caja	Código Barras	€ / Ud.
<b>62011</b>	M10 x 100 mm.	25	8435195827880	<b>1,14</b>

### JUEGO 2 TORNILLOS FIJACIÓN TAZA / TANQUE ACERO INOX



Código	Medida	Caja	Código Barras	€ / Ud.
<b>62013</b>	95 mm.	25	8435195809589	<b>1,71</b>

### JUEGO 2 TORNILLOS FIJACIÓN TAZA / TANQUE ACERO



Código	Medida	Caja	Código Barras	€ / Ud.
<b>62006</b>	95 mm.	25	8435195809572	<b>1,28</b>

### JUEGO 2 TORNILLOS FIJACIÓN TAZA / TANQUE NYLON

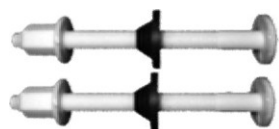

Código	Medida	Caja	Código Barras	€ / Ud.
<b>62014</b>	95 mm.	25	8435195822670	<b>0,68</b>

### JUEGO 2 TORNILLOS FIJACIÓN SOPORTE CALENTADOR



Código	Medida	Caja	Código Barras	€ / Ud.
<b>62007</b>	M8 x 60 mm.	25	8435195809596	<b>0,64</b>
<b>62008</b>	M8 x 70 mm.	25	8435195809602	<b>0,71</b>

### JUEGO 2 ESCUADRAS SOPORTE LAVABO



Código	Medida	Caja	Código Barras	€ / Ud.
<b>63002</b>	10 cm.	100	8435195809657	<b>1,47</b>
<b>63003</b>	12 cm.	100	8435195809664	<b>2,38</b>

### TACOS ESTRIADOS DE NYLON



Código	Medida	Caja	Código Barras	€ / Ud.
<b>62502</b>	6 Ø	100	8435195809619	<b>0,019</b>
<b>62504</b>	8 Ø	100	8435195809626	<b>0,024</b>
<b>62506</b>	10 Ø	50	8435195809633	<b>0,042</b>
<b>62508</b>	12 Ø	50	8435195809640	<b>0,077</b>





## RACORERÍA DE LATÓN ROSCAR

<b>Machón doble</b>		<b>174</b>
<b>Marsella hexagonal</b>		<b>176</b>
<b>Reducción hexagonal</b>		<b>177</b>
<b>Reducción lisa</b>		<b>177</b>
<b>Codos</b>		<b>178</b>
<b>Te H-H-H</b>		<b>180</b>
<b>Manguitos</b>		<b>181</b>
<b>Tapón Hembra</b>		<b>182</b>
<b>Tapón Macho</b>		<b>183</b>
<b>Unión 3 piezas</b>		<b>184</b>
<b>Racor depósito uralita</b>		<b>185</b>
<b>Arandela acero y latón</b>		<b>185</b>
<b>Tuercas correderas</b>		<b>186</b>
<b>Alargaderas cilíndricas pulidas y cromadas</b>		<b>186</b>
<b>Codo 3 bocas, cruz 4 bocas, Te 5 vías</b>		<b>187</b>
<b>Bebedero de cerdo</b>		<b>187</b>
<b>Curvas de 90°</b>		<b>187</b>
<b>Collarines</b>		<b>188</b>
<b>Maguitos electrolíticos</b>		<b>188</b>

## RACORERÍA DE LATÓN ROSCAR



### MACHÓN DOBLE M-M (TH280)



Código	Medida	Caja	Código Barras	€ / Ud.
<b>66000</b>	1/8"	100	8435195810202	<b>0,43</b>
<b>66001</b>	1/4"	100	8435195810219	<b>0,50</b>
<b>66002</b>	3/8"	100	8435195810226	<b>0,63</b>
<b>66003</b>	1/2"	100	8435195810233	<b>0,69</b>
<b>66004</b>	3/4"	25	8435195810240	<b>1,05</b>
<b>66005</b>	1"	25	8435195810257	<b>1,76</b>
<b>66006</b>	1 1/4"	10	8435195810264	<b>2,99</b>
<b>66007</b>	1 1/2"	10	8435195810271	<b>3,99</b>
<b>66008</b>	2"	5	8435195810288	<b>6,75</b>
<b>66009</b>	2 1/2"	2	8435195810295	<b>13,67</b>
<b>66015</b>	3"	2	8435195810301	<b>19,99</b>
<b>66016</b>	4"	2	8435195810318	<b>52,70</b>

### MACHÓN DOBLE CROMADO M-M (TH280)



Código	Medida	Caja	Código Barras	€ / Ud.
<b>66010</b>	1/4"	100	8435195810325	<b>0,55</b>
<b>66011</b>	3/8"	100	8435195810332	<b>0,76</b>
<b>66012</b>	1/2"	100	8435195810349	<b>0,94</b>
<b>66013</b>	3/4"	50	8435195810356	<b>1,10</b>
<b>66014</b>	1"	25	8435195810363	<b>2,14</b>
<b>66020</b>	1 1/4"	5	8435195827033	<b>3,93</b>
<b>66021</b>	1 1/2"	5	8435195827040	<b>4,65</b>
<b>66022</b>	2"	5	8435195827057	<b>7,72</b>
<b>66023</b>	2 1/2"	1	8435195827064	<b>16,35</b>

### MACHÓN DOBLE REDUCIDO M-M (TH245)



Código	Medida	Caja	Código Barras	€ / Ud.
<b>67017</b>	1/8" x 3/8"	100	8435195827071	<b>0,88</b>
<b>67028</b>	1/4" x 1/8"	100	8435195810370	<b>0,69</b>
<b>67000</b>	1/4" x 3/8"	100	8435195810387	<b>0,76</b>
<b>67029</b>	1/2" x 1/4"	100	8435195810394	<b>0,85</b>
<b>67001</b>	1/2" x 3/8"	100	8435195810400	<b>0,69</b>
<b>67002</b>	3/4" x 1/2"	25	8435195810417	<b>1,06</b>
<b>67033</b>	3/4" x 7/8"	25	8435195823226	<b>2,28</b>
<b>67003</b>	1" x 3/4"	50	8435195810424	<b>1,85</b>
<b>67004</b>	1 1/4" x 1"	10	8435195810431	<b>3,34</b>
<b>67005</b>	1 1/2" x 1 1/4"	10	8435195810448	<b>4,88</b>
<b>67006</b>	2" x 1 1/2"	5	8435195810455	<b>7,34</b>
<b>67007</b>	1" x 1/2"	25	8435195810462	<b>1,79</b>
<b>67008</b>	1 1/2" x 1/2"	10	8435195810479	<b>4,10</b>
<b>67030</b>	1 1/4" x 1/2"	10	8435195810486	<b>3,43</b>
<b>67015</b>	1 1/4" x 3/4"	10	8435195810493	<b>3,20</b>
<b>67020</b>	1 1/2" x 3/4"	10	8435195810509	<b>4,20</b>
<b>67021</b>	1 1/2" x 1"	10	8435195810516	<b>4,88</b>
<b>67022</b>	2" x 3/4"	5	8435195810523	<b>7,12</b>
<b>67023</b>	2" x 1"	5	8435195810530	<b>7,12</b>
<b>67024</b>	2" x 1 1/4"	5	8435195810547	<b>7,14</b>
<b>67009</b>	2 1/2" x 1 1/4"	2	8435195827088	<b>14,32</b>
<b>67014</b>	2 1/2" x 1 1/2"	2	8435195827095	<b>14,32</b>
<b>67025</b>	2 1/2" x 2"	2	8435195810554	<b>13,10</b>
<b>67026</b>	3" x 2"	2	8435195810561	<b>21,67</b>
<b>67027</b>	3" x 2 1/2"	2	8435195810578	<b>23,22</b>
<b>67031</b>	4" x 2 1/2"	2	8435195810585	<b>68,10</b>
<b>67032</b>	4" x 3"	2	8435195810592	<b>64,91</b>



## RACORERÍA DE LATÓN ROSCAR



### MACHÓN DOBLE REDUCIDO CROMADO M-M (TH245)



Código	Medida	Caja	Código Barras	€ / Ud.
<b>67010</b>	1/2" x 3/8"	100	8435195810608	<b>0,79</b>
<b>67011</b>	3/4" x 1/2"	100	8435195810615	<b>1,29</b>
<b>67012</b>	1" x 3/4"	50	8435195810622	<b>2,12</b>
<b>67041</b>	1 1/4" x 1"	5	8435195827101	<b>3,62</b>
<b>67042</b>	1 1/2" x 1 1/4"	5	8435195827118	<b>5,65</b>
<b>67043</b>	2 x 1 1/2"	5	8435195827125	<b>8,80</b>
<b>67044</b>	1 x 1/2"	5	8435195827132	<b>2,21</b>
<b>67045</b>	1 1/2" x 1/2"	5	8435195827149	<b>4,86</b>
<b>67046</b>	1 1/4" x 1/2"	5	8435195827156	<b>3,98</b>
<b>67047</b>	1 1/4" x 3/4"	5	8435195827163	<b>3,70</b>
<b>67048</b>	1 1/2" x 3/3"	5	8435195827170	<b>4,89</b>
<b>67049</b>	1 1/2" x 1"	5	8435195827187	<b>6,62</b>
<b>67050</b>	2" x 3/4"	5	8435195827194	<b>7,98</b>
<b>67051</b>	2" x 1"	5	8435195827200	<b>7,98</b>
<b>67052</b>	2 x 1 1/4"	5	8435195827217	<b>8,56</b>
<b>67053</b>	2 1/2" x 2"	5	8435195827224	<b>14,67</b>

### MACHÓN MONOBLOC M-M



Código	Medida	Caja	Código Barras	€ / Ud.
<b>65501</b>	1/2" x 3/8" 32 mm.	50	8435195810165	<b>1,15</b>

### MACHÓN MONOBLOC CROMADO M-M



Código	Medida	Caja	Código Barras	€ / Ud.
<b>65502</b>	1/2" x 3/8" 32 mm.	50	8435195810172	<b>1,39</b>

### MACHÓN MONOBLOC MEDIA ROSCA M-M



Código	Medida	Caja	Código Barras	€ / Ud.
<b>65507</b>	1/2" x 3/8" 40 mm.	25	8435195810189	<b>1,36</b>

### MACHÓN MONOBLOC MEDIA ROSCA CROMADO M-M



Código	Medida	Caja	Código Barras	€ / Ud.
<b>65508</b>	1/2" x 3/8" 40 mm.	25	8435195810196	<b>1,55</b>

### MACHÓN MONOBLOC CON TUERCA Y BICONO CROMADO M-M



Código	Medida	Caja	Código Barras	€ / Ud.
<b>65001</b>	1/2" x 3/8"	50	8435195810141	<b>1,27</b>
<b>65002</b>	1/2" x 3/8" 32 mm.	50	8435195810158	<b>1,76</b>

## RACORERÍA DE LATÓN ROSCAR



### MARSELLA HEXAGONAL M-H (TH529)



Código	Medida	Caja	Código Barras	€ / Ud.
<b>68001</b>	3/8"	100	8435195810639	<b>0,63</b>
<b>68002</b>	1/2"	100	8435195810646	<b>0,69</b>
<b>68003</b>	1/2" x 2 cm.	100	8435195810653	<b>1,12</b>
<b>68009</b>	1/2" x 3 cm.	25	8435195810660	<b>1,46</b>
<b>68016</b>	1/2" HEXÁGONO INTERIOR	25	8435195810776	<b>0,99</b>
<b>68004</b>	3/4"	50	8435195810677	<b>1,28</b>
<b>68005</b>	1"	25	8435195810684	<b>2,12</b>
<b>68006</b>	1 1/4"	10	8435195810691	<b>4,22</b>
<b>68007</b>	1 1/2"	5	8435195810707	<b>5,99</b>
<b>68008</b>	2"	5	8435195810714	<b>8,98</b>

### MARSELLA HEXAGONAL CROMADA M-H (TH529)



Código	Medida	Caja	Código Barras	€ / Ud.
<b>68010</b>	3/8"	50	8435195810721	<b>0,72</b>
<b>68011</b>	1/2"	100	8435195810738	<b>0,89</b>
<b>68012</b>	1/2" x 2 cm.	100	8435195810745	<b>1,36</b>
<b>68013</b>	3/4"	50	8435195810752	<b>1,39</b>
<b>68014</b>	1"	25	8435195810769	<b>2,45</b>

### MARSELLA HEXAGONAL REDUCIDA M-H (TH246)



Código	Medida	Caja	Código Barras	€ / Ud.
<b>69023</b>	1/8" x 1/4"	100	8435195810783	<b>1,28</b>
<b>69001</b>	3/8" x 1/2"	100	8435195810790	<b>0,74</b>
<b>69020</b>	3/8" x 3/4"	100	8435195841978	<b>1,61</b>
<b>69002</b>	1/2" x 3/8"	100	8435195810806	<b>0,78</b>
<b>69003</b>	1/2" x 3/4"	100	8435195810813	<b>1,24</b>
<b>98023</b>	1/2" x 1"	25	8435195810820	<b>2,22</b>
<b>69018</b>	1/2" x 1 1/4"	10	8435195810837	<b>4,90</b>
<b>69004</b>	3/4" x 1/2"	50	8435195810844	<b>1,28</b>
<b>69005</b>	3/4" x 1"	25	8435195810851	<b>1,95</b>
<b>69017</b>	3/4" x 1 1/4"	10	8435195810875	<b>4,48</b>
<b>69019</b>	3/4" x 2"	5	8435195810912	<b>9,86</b>
<b>69024</b>	1" x 1/2"	5	8435195824681	<b>2,95</b>
<b>69006</b>	1" x 3/4"	25	8435195810868	<b>2,22</b>
<b>69007</b>	1" x 1 1/4"	10	8435195810882	<b>3,83</b>
<b>69009</b>	1" x 1 1/2"	5	8435195810899	<b>5,28</b>
<b>69022</b>	1" x 2"	5	8435195810929	<b>10,10</b>
<b>69016</b>	1 1/4" x 1 1/2"	5	8435195810905	<b>6,60</b>
<b>90092</b>	1 1/4" x 2"	5	8435195810936	<b>10,10</b>
<b>99228</b>	1 1/2" x 2"	5	8435195810943	<b>10,10</b>
<b>69008</b>	2" x 2 1/2"	5	8435195810950	<b>14,98</b>

### MARSELLA HEXAGONAL REDUCIDA CROMADA M-H (TH246)



Código	Medida	Caja	Código Barras	€ / Ud.
<b>69010</b>	3/8" x 1/2"	100	8435195810967	<b>0,90</b>
<b>69011</b>	1/2" x 3/8"	100	8435195810974	<b>0,94</b>
<b>69012</b>	1/2" x 3/4"	100	8435195810981	<b>1,44</b>
<b>69013</b>	3/4" x 1/2"	25	8435195810998	<b>1,47</b>
<b>69014</b>	3/4" x 1"	25	8435195811001	<b>2,36</b>
<b>69015</b>	1" x 3/4"	25	8435195811018	<b>2,55</b>

## RACORERÍA DE LATÓN ROSCAR



### REDUCCIÓN HEXAGONAL M-H (TH241)



Código	Medida	Caja	Código Barras	€ / Ud.
<b>99091</b>	1/4" x 1/8"	100	8435195809831	<b>0,62</b>
<b>64000</b>	3/8" x 1/4"	100	8435195809848	<b>0,49</b>
<b>64024</b>	1/2" x 1/8"	100	8435195809855	<b>0,98</b>
<b>64001</b>	1/2" x 1/4"	100	8435195809862	<b>0,76</b>
<b>64002</b>	1/2" x 3/8"	100	8435195809879	<b>0,59</b>
<b>64003</b>	3/4" x 1/2"	100	8435195809886	<b>0,83</b>
<b>64004</b>	1" x 1/2"	50	8435195809893	<b>1,62</b>
<b>64005</b>	1" x 3/4"	50	8435195809909	<b>1,30</b>
<b>64027</b>	1 1/4" x 1/2"	10	8435195809916	<b>2,98</b>
<b>64006</b>	1 1/4" x 3/4"	10	8435195809923	<b>2,89</b>
<b>64007</b>	1 1/4" x 1"	10	8435195809930	<b>2,49</b>
<b>64025</b>	1 1/2" x 1/2"	10	8435195809947	<b>4,35</b>
<b>64008</b>	1 1/2" x 3/4"	10	8435195809954	<b>4,29</b>
<b>64009</b>	1 1/2" x 1"	10	8435195809961	<b>3,96</b>
<b>64010</b>	1 1/2" x 1 1/4"	10	8435195809978	<b>3,07</b>
<b>64019</b>	2" x 1/2"	10	8435195809985	<b>5,96</b>
<b>64011</b>	2" x 3/4"	10	8435195809992	<b>5,96</b>
<b>64012</b>	2" x 1"	10	8435195810004	<b>5,98</b>
<b>64013</b>	2" x 1 1/4"	10	8435195810011	<b>5,99</b>
<b>64014</b>	2" x 1 1/2"	10	8435195810028	<b>5,65</b>
<b>64030</b>	2 1/2" x 3/4"	1	8435195823165	<b>18,93</b>
<b>64031</b>	2 1/2" x 1"	1	8435195823172	<b>18,93</b>
<b>64033</b>	2 1/2" x 1 1/4"	1	8435195823189	<b>18,93</b>
<b>64034</b>	2 1/2" x 1 1/2"	1	8435195823196	<b>19,11</b>
<b>64015</b>	2 1/2" x 2"	5	8435195810035	<b>16,80</b>
<b>64035</b>	3" x 1 1/4"	1	8435195823202	<b>26,18</b>
<b>64016</b>	3" x 2"	5	8435195810042	<b>23,96</b>
<b>64017</b>	3" x 2 1/2"	5	8435195810059	<b>23,96</b>
<b>64037</b>	4" x 2"	1	8435195828269	<b>60,54</b>
<b>64028</b>	4" x 2 1/2"	1	8435195810066	<b>60,54</b>
<b>64029</b>	4" x 3"	1	8435195810073	<b>60,54</b>

### REDUCCIÓN LISA M-H



Código	Medida	Caja	Código Barras	€ / Ud.
<b>64020</b>	3/8" x 1/4"	100	8435195810080	<b>0,80</b>
<b>64021</b>	1/2" x 3/8"	100	8435195810097	<b>0,69</b>
<b>64042</b>	7/8" x 3/4"	100	8435195841671	<b>1,43</b>
<b>64022</b>	3/4" x 1/2"	100	8435195810103	<b>1,26</b>
<b>64041</b>	1" x 1/2"	50	8435195841664	<b>2,45</b>
<b>64023</b>	1" x 3/4"	50	8435195810110	<b>1,41</b>

# RACORERÍA DE LATÓN ROSCAR



## CODO H-H (TH90)



Código	Medida	Caja	Código Barras	€ / Ud.
<b>46002</b>	3/8"	50	8435195804638	<b>1,30</b>
<b>46003</b>	1/2"	50	8435195804645	<b>1,69</b>
<b>46004</b>	3/4"	25	8435195804652	<b>2,39</b>
<b>46005</b>	1"	10	8435195804669	<b>3,81</b>
<b>46006</b>	1 1/4"	10	8435195804676	<b>5,99</b>
<b>46007</b>	1 1/2"	10	8435195804683	<b>7,89</b>
<b>46008</b>	2"	5	8435195804690	<b>13,67</b>
<b>46009</b>	2 1/2"	2	8435195804706	<b>27,07</b>
<b>46010</b>	3"	2	8435195804713	<b>38,52</b>
<b>46011</b>	4"	2	8435195804720	<b>126,15</b>

## CODO CROMADO H-H (TH90)



Código	Medida	Caja	Código Barras	€ / Ud.
<b>46012</b>	3/8"	50	8435195804737	<b>1,49</b>
<b>46013</b>	1/2"	25	8435195804744	<b>1,96</b>
<b>46014</b>	3/4"	25	8435195804751	<b>2,83</b>
<b>46015</b>	1"	10	8435195804768	<b>4,69</b>

## CODO REDUCIDO H-H (TH90/R)



Código	Medida	Caja	Código Barras	€ / Ud.
<b>46032</b>	3/8" x 1/2"	50	8435195804775	<b>1,98</b>
<b>46033</b>	1/2" x 3/4"	25	8435195804782	<b>1,99</b>
<b>46034</b>	3/4" x 1"	5	8435195804799	<b>2,86</b>
<b>46035</b>	1/2" x 1"	5	8435195804805	<b>3,18</b>

## CODO REDUCIDO CROMADO H-H (TH90/R)



Código	Medida	Caja	Código Barras	€ / Ud.
<b>46037</b>	3/8" x 1/2"	50	8435195804812	<b>2,60</b>
<b>46038</b>	1/2" x 3/4"	25	8435195804829	<b>2,80</b>
<b>46039</b>	3/4" x 1"	10	8435195804836	<b>3,70</b>

## RACORERÍA DE LATÓN ROSCAR



### CODO M-H (TH92)



Código	Medida	Caja	Código Barras	€ / Ud.
<b>47002</b>	3/8"	50	8435195804867	<b>1,31</b>
<b>47003</b>	1/2"	50	8435195804874	<b>1,55</b>
<b>47004</b>	3/4"	25	8435195804881	<b>2,38</b>
<b>47005</b>	1"	10	8435195804898	<b>3,58</b>
<b>47006</b>	1 1/4"	10	8435195804904	<b>5,99</b>
<b>47007</b>	1 1/2"	10	8435195804911	<b>7,78</b>
<b>47008</b>	2"	5	8435195804928	<b>10,46</b>
<b>47009</b>	2 1/2"	2	8435195804935	<b>27,90</b>
<b>47010</b>	3"	2	8435195804942	<b>62,70</b>
<b>47011</b>	4"	2	8435195804959	<b>129,33</b>

### CODO CROMADO M-H (TH92)



Código	Medida	Caja	Código Barras	€ / Ud.
<b>47012</b>	3/8"	50	8435195804966	<b>1,49</b>
<b>47013</b>	1/2"	25	8435195804973	<b>1,83</b>
<b>47014</b>	3/4"	25	8435195804980	<b>2,66</b>
<b>47015</b>	1"	10	8435195804997	<b>4,46</b>

### CODO REDUCIDO M-H (TH92/R)



Código	Medida	Caja	Código Barras	€ / Ud.
<b>47032</b>	1/2" x 3/4"	25	8435195805000	<b>3,79</b>
<b>47033</b>	3/4" x 1"	10	8435195805017	<b>7,08</b>
<b>47034</b>	1" x 1 1/4"	5	8435195805024	<b>13,28</b>

### CODO REDUCIDO CROMADO M-H (TH92/R)



Código	Medida	Caja	Código Barras	€ / Ud.
<b>47037</b>	1/2" x 3/4"	25	8435195805031	<b>4,11</b>
<b>47038</b>	3/4" x 1"	10	8435195805048	<b>7,62</b>
<b>47039</b>	1" x 1 1/4"	5	8435195805055	<b>14,98</b>

## RACORERÍA DE LATÓN ROSCAR



### TE H-H-H (TH130)



Código	Medida	Caja	Código Barras	€ / Ud.
<b>45001</b>	1/4"	10	8435195826968	<b>2,45</b>
<b>45002</b>	3/8"	50	8435195804492	<b>1,76</b>
<b>45003</b>	1/2"	50	8435195804508	<b>2,09</b>
<b>45004</b>	3/4"	25	8435195804515	<b>2,96</b>
<b>45005</b>	1"	10	8435195804522	<b>4,79</b>
<b>45006</b>	1 1/4"	5	8435195804539	<b>7,90</b>
<b>45007</b>	1 1/2"	5	8435195804546	<b>10,67</b>
<b>45008</b>	2"	5	8435195804553	<b>14,90</b>
<b>45009</b>	2 1/2"	2	8435195804560	<b>34,82</b>
<b>45010</b>	3"	2	8435195804577	<b>49,85</b>
<b>45011</b>	4"	2	8435195804584	<b>116,74</b>

### TE CROMADA H-H-H (TH130)



Código	Medida	Caja	Código Barras	€ / Ud.
<b>45012</b>	3/8"	50	8435195804591	<b>1,89</b>
<b>45013</b>	1/2"	25	8435195804607	<b>2,42</b>
<b>45014</b>	3/4"	25	8435195804614	<b>3,37</b>
<b>45015</b>	1"	10	8435195804621	<b>4,87</b>

### TE REDUCIDA H-H-H (TH130)



Código	Medida	Caja	Código Barras	€ / Ud.
<b>45016</b>	3/4" x 1/2" x 3/4"	1	8435195833133	<b>2,90</b>
<b>45021</b>	3/4" x 3/4" x 1/2"	1	8435195833140	<b>6,15</b>
<b>45017</b>	1" x 3/4" x 1"	1	8435195833157	<b>4,16</b>
<b>45018</b>	1" x 1/2" x 1"	1	8435195833164	<b>3,98</b>
<b>45019</b>	1 1/4" x 1/2" x 1 1/4"	1	8435195833171	<b>6,98</b>
<b>45020</b>	1 1/4" x 3/4" x 1 1/4"	1	8435195833188	<b>6,80</b>
<b>45037</b>	1 1/4" x 1" x 1 1/4"	1	8435195833195	<b>7,18</b>
<b>45032</b>	1 1/2" x 1/2" x 1 1/2"	1	8435195833201	<b>10,24</b>
<b>45035</b>	1 1/2" x 3/4" x 1 1/2"	1	8435195833218	<b>8,75</b>
<b>45024</b>	1 1/2" x 1" x 1 1/2"	1	8435195833225	<b>8,74</b>
<b>45027</b>	1 1/2" x 1 1/4" x 1 1/2"	1	8435195833232	<b>8,75</b>
<b>45036</b>	2" x 3/4" x 2"	1	8435195833249	<b>14,97</b>
<b>45033</b>	2" x 1 1/4" x 2"	1	8435195833256	<b>14,97</b>
<b>45034</b>	2" x 1 1/2" x 2"	1	8435195833263	<b>14,97</b>

## RACORERÍA DE LATÓN ROSCAR



### MANGUITO H-H (TH270)



Código	Medida	Caja	Código Barras	€ / Ud.
<b>48001</b>	1/4"	50	8435195838107	<b>1,56</b>
<b>48002</b>	3/8"	50	8435195805222	<b>1,15</b>
<b>48003</b>	1/2"	50	8435195805239	<b>1,39</b>
<b>48004</b>	3/4"	25	8435195805246	<b>1,85</b>
<b>48005</b>	1"	10	8435195805253	<b>2,73</b>
<b>48006</b>	1 1/4"	5	8435195805260	<b>4,58</b>
<b>48007</b>	1 1/2"	5	8435195805277	<b>5,62</b>
<b>48008</b>	2"	5	8435195805284	<b>8,40</b>
<b>48009</b>	2 1/2"	2	8435195805291	<b>20,89</b>
<b>48010</b>	3"	2	8435195805307	<b>26,07</b>
<b>48011</b>	4"	2	8435195805314	<b>55,36</b>

### MANGUITO CROMADO H-H (TH270)



Código	Medida	Caja	Código Barras	€ / Ud.
<b>48012</b>	3/8"	50	8435195805321	<b>1,29</b>
<b>48013</b>	1/2"	50	8435195805338	<b>1,57</b>
<b>48014</b>	3/4"	25	8435195805345	<b>2,17</b>
<b>48015</b>	1"	10	8435195805352	<b>3,17</b>

### MANGUITO REDUCIDO H-H (TH240)



Código	Medida	Caja	Código Barras	€ / Ud.
<b>48017</b>	3/8" x 1/2"	50	8435195805369	<b>1,45</b>
<b>48018</b>	1/2" x 3/4"	25	8435195805376	<b>1,68</b>
<b>48065</b>	1/2" x 1"	25	8435195838183	<b>3,10</b>
<b>48019</b>	3/4" x 1"	10	8435195805383	<b>2,54</b>
<b>48020</b>	1" x 1 1/4"	10	8435195805390	<b>3,99</b>
<b>48024</b>	1" x 2"	5	8435195805437	<b>6,66</b>
<b>48021</b>	1 1/4" x 1 1/2"	5	8435195805406	<b>4,85</b>
<b>48023</b>	1 1/4" x 2"	5	8435195805420	<b>7,36</b>
<b>48022</b>	1 1/2" x 2"	5	8435195805413	<b>7,70</b>
<b>48025</b>	2 1/2" x 2"	1	8435195826999	<b>12,95</b>
<b>48029</b>	3" x 2"	1	8435195838114	<b>34,47</b>

### MANGUITO REDUCIDO CROMADO H-H (TH240)



Código	Medida	Caja	Código Barras	€ / Ud.
<b>48026</b>	3/8" x 1/2"	50	8435195805444	<b>1,58</b>
<b>48027</b>	1/2" x 3/4"	50	8435195805451	<b>1,91</b>
<b>48028</b>	3/4" x 1"	25	8435195805468	<b>2,65</b>

## RACORERÍA DE LATÓN ROSCAR



### TAPÓN HEMBRA (TH300)



Código	Medida	Caja	Código Barras	€ / Ud.
<b>70000</b>	1/8"	100	8435195811384	<b>0,36</b>
<b>70001</b>	1/4"	100	8435195811391	<b>0,50</b>
<b>70002</b>	3/8"	100	8435195811407	<b>0,37</b>
<b>70003</b>	1/2"	100	8435195811414	<b>0,53</b>
<b>70004</b>	3/4"	50	8435195811421	<b>0,89</b>
<b>70005</b>	1"	25	8435195811438	<b>1,56</b>
<b>70006</b>	1 1/4"	10	8435195811445	<b>2,46</b>
<b>70007</b>	1 1/2"	10	8435195811452	<b>3,43</b>
<b>70008</b>	2"	5	8435195811469	<b>4,99</b>
<b>70009</b>	2 1/2"	2	8435195811476	<b>14,31</b>
<b>70010</b>	3"	2	8435195811483	<b>22,64</b>
<b>70011</b>	4"	2	8435195811490	<b>33,66</b>

### TAPÓN HEMBRA CROMADO (TH300)



Código	Medida	Caja	Código Barras	€ / Ud.
<b>70018</b>	3/8"	25	8435195827231	<b>0,49</b>
<b>70019</b>	1/2"	25	8435195827248	<b>0,61</b>
<b>70020</b>	3/4"	10	8435195827255	<b>0,99</b>
<b>70021</b>	1"	5	8435195827262	<b>1,78</b>

### TAPÓN HEMBRA CON PRECINTO PARA GAS



Código	Medida	Caja	Código Barras	€ / Ud.
<b>70014</b>	1/2"	100	8435195800906	<b>0,90</b>
<b>70015</b>	3/4"	50	8435195827279	<b>1,25</b>
<b>70016</b>	1"	25	8435195827286	<b>1,78</b>
<b>70017</b>	7/8"	25	8435195827293	<b>2,51</b>



## RACORERÍA DE LATÓN ROSCAR



### TAPÓN MACHO (TH290)



Código	Medida	Caja	Código Barras	€ / Ud.
<b>70500</b>	1/8"	100	8435195811506	<b>0,41</b>
<b>70501</b>	1/4"	100	8435195811513	<b>0,52</b>
<b>70502</b>	3/8"	100	8435195811520	<b>0,61</b>
<b>70503</b>	1/2"	100	8435195811537	<b>0,56</b>
<b>70504</b>	3/4"	50	8435195811544	<b>0,99</b>
<b>70505</b>	1"	25	8435195811551	<b>1,49</b>
<b>70506</b>	1 1/4"	10	8435195811568	<b>2,78</b>
<b>70507</b>	1 1/2"	10	8435195811575	<b>3,23</b>
<b>70508</b>	2"	5	8435195811582	<b>5,14</b>
<b>70509</b>	2 1/2"	1	8435195811599	<b>15,17</b>
<b>70510</b>	3"	1	8435195811605	<b>19,74</b>
<b>70511</b>	4"	1	8435195811612	<b>40,50</b>

### TAPÓN MACHO CROMADO (TH290)



Código	Medida	Caja	Código Barras	€ / Ud.
<b>70512</b>	3/8"	25	8435195827309	<b>0,67</b>
<b>70513</b>	1/2"	25	8435195827316	<b>0,67</b>
<b>70514</b>	3/4"	25	8435195827323	<b>1,11</b>
<b>70520</b>	1"	5	8435195827330	<b>1,74</b>

### TAPÓN MACHO CON PRECINTO PARA GAS



Código	Medida	Caja	Código Barras	€ / Ud.
<b>70515</b>	1/2"	100	8435195828054	<b>0,99</b>
<b>70516</b>	3/4"	50	8435195828061	<b>1,61</b>
<b>70518</b>	1"	25	8435195828078	<b>2,26</b>
<b>70519</b>	7/8"	25	8435195828078	<b>2,19</b>

## RACORERÍA DE LATÓN ROSCAR



### UNIÓN 3 PIEZAS H-H CIERRE CÓNICO (TH340)



Código	Medida	Caja	Código Barras	€ / Ud.
<b>69501</b>	1/2"	10	8435195811032	<b>4,67</b>
<b>69502</b>	3/4"	10	8435195811049	<b>6,32</b>
<b>69503</b>	1"	5	8435195811056	<b>8,50</b>
<b>69504</b>	1 1/4"	5	8435195811063	<b>12,80</b>
<b>69505</b>	1 1/2"	2	8435195811070	<b>15,95</b>
<b>69506</b>	2"	2	8435195811087	<b>21,98</b>
<b>69507</b>	2 1/2"	1	8435195824339	<b>64,97</b>
<b>69508</b>	3"	1	8435195827347	<b>75,80</b>
<b>69509</b>	4"	1	8435195827354	<b>298,08</b>

### UNIÓN 3 PIEZAS H-H CIERRE JUNTA PLANA



Código	Medida	Caja	Código Barras	€ / Ud.
<b>69581</b>	1/2"	10	8435195833270	<b>4,79</b>
<b>69582</b>	3/4"	10	8435195833287	<b>7,15</b>
<b>69583</b>	1"	5	8435195833294	<b>9,60</b>
<b>69584</b>	1 1/4"	2	8435195833300	<b>17,68</b>
<b>69585</b>	1 1/2"	2	8435195833317	<b>22,48</b>
<b>69586</b>	2"	1	8435195833324	<b>28,24</b>

### UNIÓN 3 PIEZAS M-H CIERRE CÓNICO (TH341)



Código	Medida	Caja	Código Barras	€ / Ud.
<b>69510</b>	1/2"	10	8435195811094	<b>4,95</b>
<b>69511</b>	3/4"	10	8435195811100	<b>7,24</b>
<b>69512</b>	1"	5	8435195811117	<b>10,45</b>
<b>69513</b>	1 1/4"	5	8435195811124	<b>13,99</b>
<b>69514</b>	1 1/2"	2	8435195811131	<b>19,97</b>
<b>69515</b>	2"	2	8435195811148	<b>23,96</b>
<b>69516</b>	2 1/2"	1	8435195824346	<b>74,57</b>

### UNIÓN 3 PIEZAS M-H CIERRE JUNTA PLANA



Código	Medida	Caja	Código Barras	€ / Ud.
<b>69591</b>	1/2"	10	8435195833331	<b>5,33</b>
<b>69592</b>	3/4"	10	8435195833348	<b>7,73</b>
<b>69593</b>	1"	5	8435195833355	<b>10,50</b>
<b>69594</b>	1 1/4"	5	8435195833362	<b>18,16</b>
<b>69595</b>	1 1/2"	2	8435195833379	<b>20,42</b>
<b>69596</b>	2"	2	8435195833386	<b>27,88</b>

## RACORERÍA DE LATÓN ROSCAR



### RACOR DEPÓSITO URALITA CON TUERCA CORREDERA



Código	Medida	Caja	Código Barras	€ / Ud.
<b>59402</b>	3/8"	25	8435195808636	<b>1,96</b>
<b>59403</b>	1/2"	25	8435195808643	<b>2,27</b>
<b>59404</b>	3/4"	15	8435195808650	<b>3,30</b>
<b>59405</b>	1"	10	8435195808667	<b>4,82</b>
<b>59406</b>	1 1/4"	6	8435195808674	<b>6,93</b>
<b>59407</b>	1 1/2"	5	8435195808681	<b>9,60</b>
<b>59408</b>	2"	2	8435195808698	<b>15,95</b>
<b>59409</b>	2 1/2"	2	8435195808704	<b>36,76</b>
<b>59410</b>	3"	2	8435195808711	<b>57,60</b>

### RACOR DEPÓSITO URALITA CON TUERCA CORREDERA Y TUBO



Código	Medida	Caja	Código Barras	€ / Ud.
<b>59603</b>	1/2"	25	8435195808728	<b>3,38</b>
<b>59604</b>	3/4"	25	8435195808735	<b>4,86</b>
<b>59605</b>	1"	10	8435195808742	<b>6,94</b>
<b>59606</b>	1 1/4"	6	8435195808759	<b>9,96</b>
<b>59607</b>	1 1/2"	4	8435195808766	<b>17,37</b>
<b>59608</b>	2"	2	8435195808773	<b>28,51</b>
<b>59609</b>	2 1/2"	2	8435195808780	<b>63,78</b>
<b>59610</b>	3"	2	8435195808797	<b>106,25</b>

### ARANDELA DE ACERO CINCADO



Código	Medida	Caja	Código Barras	€ / Ud.
<b>59615</b>	3/8" x 38	100	8435195808803	<b>0,11</b>
<b>59616</b>	1/2" x 45	100	8435195808810	<b>0,13</b>
<b>59617</b>	3/4" x 55	100	8435195808827	<b>0,15</b>
<b>59618</b>	1" x 66	50	8435195808834	<b>0,15</b>
<b>59619</b>	1 1/4" x 66	50	8435195808841	<b>0,36</b>
<b>59620</b>	1 1/2" x 78	50	8435195808858	<b>0,40</b>
<b>59621</b>	2" x 88	50	8435195808865	<b>0,49</b>

### ARANDELA DE LATÓN



Código	Medida	Caja	Código Barras	€ / Ud.
<b>59624</b>	3/8" x 38	100	8435195808872	<b>0,47</b>
<b>59625</b>	1/2" x 45	100	8435195808889	<b>0,52</b>
<b>59626</b>	3/4" x 55	100	8435195808896	<b>0,69</b>
<b>59627</b>	1" x 66	50	8435195808902	<b>0,99</b>
<b>59628</b>	1 1/4" x 66	50	8435195808919	<b>1,64</b>
<b>59629</b>	1 1/2" x 78	50	8435195808926	<b>1,97</b>
<b>59630</b>	2" x 88	50	8435195808933	<b>2,83</b>

# RACORERÍA DE LATÓN ROSCAR



## TUERCA CORREDERA CON VALONA



Código	Medida	Caja	Código Barras	€ / Ud.
<b>69519</b>	3/8"	100	8435195811155	<b>0,48</b>
<b>69520</b>	1/2"	100	8435195811162	<b>0,50</b>
<b>69521</b>	3/4"	100	8435195811179	<b>0,74</b>
<b>69522</b>	1"	50	8435195811186	<b>0,88</b>
<b>69523</b>	1 1/4"	25	8435195811193	<b>1,65</b>
<b>69524</b>	1 1/2"	25	8435195811209	<b>2,24</b>
<b>69525</b>	2"	25	8435195811216	<b>5,70</b>
<b>69526</b>	2 1/2"	10	8435195811223	<b>9,63</b>
<b>69527</b>	3"	10	8435195811230	<b>12,22</b>
<b>99329</b>	28/150	100	8435195847185	<b>0,80</b>

## ALARGADERA CILÍNDRICA PULIDA M-H (TH526)



Código	Medida	Caja	Código Barras	€ / Ud.
<b>58900</b>	3/8" x 30 mm.	25	8435195825664	<b>1,98</b>
<b>58901</b>	3/8" x 50 mm.	50	8435195808452	<b>2,95</b>
<b>58902</b>	3/8" x 100 mm.	50	8435195808469	<b>5,26</b>

<b>59001</b>	1/2" x 10 mm.	50	8435195808476	<b>1,25</b>
<b>59002</b>	1/2" x 20 mm.	50	8435195808483	<b>1,80</b>
<b>59003</b>	1/2" x 30 mm.	50	8435195808490	<b>1,98</b>
<b>59006</b>	1/2" x 40 mm.	25	8435195825671	<b>2,87</b>
<b>59004</b>	1/2" x 50 mm.	25	8435195808506	<b>2,17</b>
<b>59008</b>	1/2" x 60 mm.	25	8435195825688	<b>4,60</b>
<b>59009</b>	1/2" x 70 mm.	25	8435195825695	<b>4,98</b>
<b>59010</b>	1/2" x 80 mm.	25	8435195825701	<b>5,88</b>
<b>59005</b>	1/2" x 100 mm.	10	8435195808513	<b>2,99</b>

<b>59011</b>	3/4" x 50 mm.	10	8435195808520	<b>3,68</b>
<b>59012</b>	3/4" x 100 mm.	5	8435195808537	<b>5,96</b>

## ALARGADERA CILÍNDRICA CROMADA M-H (TH526)



Código	Medida	Caja	Código Barras	€ / Ud.
<b>59100</b>	3/8" x 30 mm.	25	8435195825718	<b>2,30</b>
<b>59101</b>	3/8" x 50 mm.	50	8435195808544	<b>3,23</b>
<b>59102</b>	3/8" x 100 mm.	50	8435195808551	<b>5,49</b>

<b>59201</b>	1/2" x 10 mm.	50	8435195808568	<b>1,45</b>
<b>59202</b>	1/2" x 20 mm.	50	8435195808575	<b>2,05</b>
<b>59203</b>	1/2" x 30 mm.	50	8435195808582	<b>2,88</b>
<b>59206</b>	1/2" x 40 mm.	25	8435195825725	<b>3,27</b>
<b>59204</b>	1/2" x 50 mm.	25	8435195808599	<b>2,59</b>
<b>59208</b>	1/2" x 60 mm.	25	8435195825732	<b>4,65</b>
<b>59209</b>	1/2" x 70 mm.	25	8435195825756	<b>5,48</b>
<b>59210</b>	1/2" x 80 mm.	25	8435195825763	<b>6,69</b>
<b>59205</b>	1/2" x 100 mm.	10	8435195808605	<b>3,47</b>

<b>59211</b>	3/4" x 50 mm.	10	8435195808612	<b>3,96</b>
<b>59212</b>	3/4" x 100 mm.	5	8435195808629	<b>5,80</b>

## RACORERÍA DE LATÓN ROSCAR



### CODO 3 BOCAS H (TH221)



Código	Medida	Caja	Código Barras	€ / Ud.
<b>46016</b>	1/2"	10	8435195804843	<b>3,58</b>
<b>46017</b>	3/4"	15	8435195804850	<b>4,50</b>

### CRUZ 4 BOCAS H (TH180)



Código	Medida	Caja	Código Barras	€ / Ud.
<b>48501</b>	3/8"	10	8435195827002	<b>2,62</b>
<b>48502</b>	1/2"	10	8435195805741	<b>3,86</b>
<b>48503</b>	3/4"	10	8435195805758	<b>5,30</b>
<b>48504</b>	1"	5	8435195805765	<b>8,26</b>
<b>48505</b>	1 1/4"	2	8435195805772	<b>12,52</b>
<b>48506</b>	1 1/2"	2	8435195805789	<b>14,71</b>
<b>48507</b>	2"	2	8435195805796	<b>23,83</b>
<b>48508</b>	2 1/2"	1	8435195827019	<b>110,90</b>
<b>48509</b>	3"	1	8435195827026	<b>144,50</b>

### RACOR TE 5 VÍAS



Código	Medida	Caja	Código Barras	€ / Ud.
<b>47101</b>	1" x 1" x 1" x 1/4" x 81 mm.	5	8435195805208	<b>6,96</b>
<b>47102</b>	1" x 1" x 1" x 1/4" x 92 mm.	5	8435195805215	<b>8,10</b>
<b>47103</b>	1" x 1" x 1" x 1/4" x 120 mm.	5	8435195833836	<b>9,14</b>

### BEBEDERO DE CERDO



Código	Medida	Caja	Código Barras	€ / Ud.
<b>99354</b>	1/2"	25	8435195811025	<b>2,65</b>

### CURVA 90° M-H (TH1)



Código	Medida	Caja	Código Barras	€ / Ud.
<b>47016</b>	1/2"	10	8435195805062	<b>4,99</b>
<b>47017</b>	3/4"	10	8435195805079	<b>6,75</b>
<b>47018</b>	1"	5	8435195805086	<b>8,41</b>
<b>47019</b>	1 1/4"	3	8435195805093	<b>14,98</b>
<b>47020</b>	1 1/2"	3	8435195805109	<b>18,15</b>
<b>47021</b>	2"	2	8435195805116	<b>29,98</b>

### CURVA 90° H-H (TH2)



Código	Medida	Caja	Código Barras	€ / Ud.
<b>47022</b>	1/2"	10	8435195805123	<b>4,25</b>
<b>47023</b>	3/4"	10	8435195805130	<b>6,75</b>
<b>47024</b>	1"	5	8435195805147	<b>8,41</b>
<b>47025</b>	1 1/4"	3	8435195805154	<b>15,51</b>
<b>47026</b>	1 1/2"	3	8435195805161	<b>19,75</b>
<b>47027</b>	2"	3	8435195805178	<b>31,98</b>
<b>47028</b>	2 1/2"	2	8435195805185	<b>53,10</b>
<b>47029</b>	3"	2	8435195805192	<b>132,62</b>

## RACORERÍA DE LATÓN ROSCAR



### COLLARÍN TOMA CON JUNTA



Código	Medida	Caja	Código Barras	€ / Ud.
<b>48030</b>	1/2" x 20	25	8435195805475	<b>5,88</b>
<b>48031</b>	1/2" x 25	25	8435195805482	<b>6,44</b>
<b>48032</b>	1/2" x 32	15	8435195805499	<b>8,15</b>
<b>48033</b>	1/2" x 40	10	8435195805505	<b>12,10</b>
<b>48034</b>	1/2" x 50	5	8435195805512	<b>13,58</b>
<b>48035</b>	1/2" x 63	5	8435195805529	<b>15,98</b>
<b>48036</b>	1/2" x 75	2	8435195805536	<b>28,86</b>
<b>48037</b>	1/2" x 90	2	8435195805543	<b>28,29</b>
<b>48038</b>	3/4" x 40	10	8435195805550	<b>12,74</b>
<b>48039</b>	3/4" x 50	5	8435195805567	<b>13,56</b>
<b>48040</b>	3/4" x 63	5	8435195805574	<b>16,27</b>
<b>48041</b>	3/4" x 75	2	8435195805581	<b>25,48</b>
<b>48042</b>	3/4" x 90	2	8435195805598	<b>28,16</b>
<b>48043</b>	1" x 63	2	8435195805604	<b>14,99</b>
<b>48044</b>	1" x 75	2	8435195805611	<b>27,52</b>
<b>48045</b>	1" x 90	2	8435195805628	<b>28,91</b>

### COLLARÍN CIEGO CON JUNTA



Código	Medida	Caja	Código Barras	€ / Ud.
<b>48050</b>	1/2" x 20	25	8435195805635	<b>5,40</b>
<b>48051</b>	3/4" x 25	25	8435195805642	<b>6,56</b>
<b>48052</b>	1" x 32	15	8435195805659	<b>8,73</b>
<b>48053</b>	1 1/4" x 40	10	8435195805666	<b>10,88</b>
<b>48054</b>	1 1/2" x 50	5	8435195805673	<b>12,95</b>
<b>48055</b>	2" x 63	2	8435195805680	<b>13,41</b>
<b>48056</b>	2 1/2" x 75	2	8435195805697	<b>16,10</b>
<b>48057</b>	3" x 90	2	8435195805703	<b>27,25</b>

### MANGUITO ELECTROLÍTICO H-H Con fibra de vidrio



Código	Medida	Caja	Código Barras	€ / Ud.
<b>72503</b>	1/2"	25	8435195812060	<b>1,68</b>
<b>72504</b>	3/4"	25	8435195812077	<b>2,40</b>
<b>72505</b>	1"	10	8435195812084	<b>3,70</b>
<b>72506</b>	1 1/4"	8	8435195812091	<b>11,55</b>
<b>72507</b>	1 1/2"	6	8435195812107	<b>17,98</b>
<b>72508</b>	2"	4	8435195812114	<b>27,72</b>
<b>72509</b>	2 1/2"	2	8435195812121	<b>44,29</b>
<b>72510</b>	3"	2	8435195812138	<b>65,26</b>
<b>72514</b>	4"	2	8435195812145	<b>84,72</b>

### MANGUITO ELECTROLÍTICO M-H Con fibra de vidrio



Código	Medida	Caja	Código Barras	€ / Ud.
<b>72602</b>	1/2"	25	8435195826975	<b>2,13</b>
<b>72603</b>	3/4"	25	8435195826982	<b>2,89</b>





### MANGUITO ELECTROLÍTICO M-H



Código	Medida	Caja	Código Barras	€ / Ud.
<b>72601</b>	1/2"	25	8435195812152	<b>1,17</b>



## RACORERÍA DE LATÓN SOLDAR

<b>Codos</b>		<b>190</b>
<b>Enlaces y entronques</b>		<b>191</b>
<b>Te H</b>		<b>192</b>
<b>Tapones</b>		<b>192</b>
<b>Curva desviación</b>		<b>192</b>

## RACORERÍA DE LATÓN SOLDAR



### CODO HEMBRA (90Gcu)



Código	Medida	Caja	Código Barras	€ / Ud.
<b>49007</b>	3/8" x 15 Ø	25	8435195805802	<b>1,20</b>
<b>49011</b>	1/2" x 12 Ø	25	8435195805819	<b>1,35</b>
<b>49001</b>	1/2" x 15 Ø	25	8435195805826	<b>1,18</b>
<b>49028</b>	1/2" x 16 Ø	25	8435195838534	<b>1,66</b>
<b>49003</b>	1/2" x 18 Ø	25	8435195805833	<b>1,56</b>
<b>49008</b>	1/2" x 22 Ø	25	8435195805840	<b>1,92</b>
<b>49009</b>	3/4" x 15 Ø	25	8435195805857	<b>2,01</b>
<b>49004</b>	3/4" x 18 Ø	25	8435195805864	<b>1,98</b>
<b>49005</b>	3/4" x 22 Ø	25	8435195805871	<b>2,81</b>
<b>49012</b>	3/4" x 28 Ø	10	8435195821192	<b>3,95</b>
<b>49010</b>	1" x 22 Ø	10	8435195805888	<b>4,16</b>
<b>49006</b>	1" x 28 Ø	10	8435195805895	<b>4,69</b>
<b>49013</b>	1 1/4" x 28 Ø	5	8435195821208	<b>8,05</b>
<b>49002</b>	1 1/4" x 35 Ø	5	8435195821215	<b>10,79</b>
<b>49014</b>	1 1/2" x 42 Ø	5	8435195821222	<b>13,54</b>
<b>49000</b>	2" x 54 Ø	2	8435195821239	<b>21,38</b>

### CODO MACHO (92Gcu)



Código	Medida	Caja	Código Barras	€ / Ud.
<b>49026</b>	1/2" x 12 Ø	25	8435195838510	<b>1,28</b>
<b>49015</b>	1/2" x 15 Ø	25	8435195805901	<b>1,38</b>
<b>49016</b>	1/2" x 18 Ø	25	8435195805918	<b>1,56</b>
<b>49017</b>	1/2" x 22 Ø	25	8435195805925	<b>1,85</b>
<b>49018</b>	3/4" x 18 Ø	25	8435195805932	<b>1,72</b>
<b>49019</b>	3/4" x 22 Ø	25	8435195805949	<b>2,55</b>
<b>49020</b>	1" x 28 Ø	10	8435195805956	<b>5,28</b>

### CODO MURAL (472Gcu)



Código	Medida	Caja	Código Barras	€ / Ud.
<b>49035</b>	1/2" x 12 Ø	25	8435195805963	<b>2,24</b>
<b>49031</b>	1/2" x 15 Ø	25	8435195805970	<b>2,18</b>
<b>49032</b>	1/2" x 18 Ø	25	8435195805987	<b>3,18</b>
<b>49037</b>	3/4" x 18 Ø	25	8435195838558	<b>3,57</b>
<b>49033</b>	3/4" x 22 Ø	25	8435195805994	<b>3,96</b>
<b>49034</b>	1" x 28 Ø	10	8435195806007	<b>8,89</b>



## RACORERÍA DE LATÓN SOLDAR



### ENLACE HEMBRA (270GCu)



Código	Medida	Caja	Código Barras	€ / Ud.
49085	3/8" x 12 Ø	25	8435195806281	<b>0,55</b>
49079	3/8" x 15 Ø	25	8435195806298	<b>0,70</b>
49077	1/2" x 10 Ø	25	8435195806304	<b>0,89</b>
49078	1/2" x 12 Ø	25	8435195806311	<b>0,86</b>
49071	1/2" x 15 Ø	25	8435195806328	<b>0,80</b>
49072	1/2" x 18 Ø	25	8435195806335	<b>0,85</b>
49073	1/2" x 22 Ø	25	8435195806342	<b>1,45</b>
49080	3/4" x 15 Ø	25	8435195806359	<b>1,43</b>
49074	3/4" x 18 Ø	25	8435195806366	<b>1,36</b>
49075	3/4" x 22 Ø	25	8435195806373	<b>1,49</b>
49084	3/4" x 28 Ø	10	8435195806380	<b>2,32</b>
49082	1" x 22 Ø	10	8435195806397	<b>1,92</b>
49076	1" x 28 Ø	10	8435195806403	<b>2,22</b>
49081	1 1/4" x 28 Ø	5	8435195806410	<b>5,39</b>
49083	1 1/4" x 35 Ø	5	8435195806427	<b>5,56</b>
49088	1 1/2" x 42 Ø	5	8435195806434	<b>6,98</b>
49022	1 1/2" x 54 Ø	5	8435195823219	<b>9,98</b>
49087	2" x 54 Ø	2	8435195806441	<b>10,11</b>

### ENTRONQUE MACHO (243GCu)



Código	Medida	Caja	Código Barras	€ / Ud.
49052	3/8" x 10 Ø	25	8435195806090	<b>0,62</b>
49068	3/8" x 12 Ø	25	8435195806106	<b>0,61</b>
49027	3/8" x 14 Ø	25	8435195838527	<b>0,70</b>
49036	3/8" x 15 Ø	25	8435195806113	<b>0,56</b>
49061	1/2" x 12 Ø	25	8435195806120	<b>0,85</b>
49024	1/2" x 14 Ø	25	8435195838503	<b>0,79</b>
49055	1/2" x 15 Ø	25	8435195806137	<b>0,68</b>
49056	1/2" x 18 Ø	25	8435195806144	<b>0,69</b>
49057	1/2" x 22 Ø	25	8435195806151	<b>1,24</b>
49062	3/4" x 15 Ø	25	8435195806168	<b>1,32</b>
49058	3/4" x 18 Ø	25	8435195806175	<b>1,74</b>
49059	3/4" x 22 Ø	25	8435195806182	<b>1,47</b>
49067	3/4" x 28 Ø	25	8435195806199	<b>2,14</b>
49064	1" x 22 Ø	10	8435195806205	<b>2,18</b>
49060	1" x 28 Ø	10	8435195806212	<b>2,47</b>
49039	1" x 35 Ø	10	8435195838572	<b>4,30</b>
49063	1 1/4" x 28 Ø	5	8435195806229	<b>4,22</b>
49065	1 1/4" x 35 Ø	5	8435195806236	<b>3,99</b>
49070	1 1/4" x 42 Ø	5	8435195806243	<b>3,99</b>
49054	1 1/2" x 35 Ø	5	8435195821284	<b>4,35</b>
49066	1 1/2" x 42 Ø	5	8435195806250	<b>4,69</b>
49086	2" x 54 Ø	2	8435195806267	<b>7,59</b>
49069	2 1/2" x 64 Ø	2	8435195806274	<b>21,93</b>
49089	3" x 76 Ø	1	8435195821291	<b>34,70</b>

## RACORERÍA DE LATÓN SOLDAR



### TE HEMBRA (130GCu)



Código	Medida	Caja	Código Barras	€ / Ud.
<b>49090</b>	3/8" x 12 Ø	25	8435195838602	<b>1,58</b>
<b>49040</b>	3/8" x 15 Ø	25	8435195838589	<b>1,58</b>
<b>49047</b>	1/2" x 12 Ø	25	8435195806014	<b>1,77</b>
<b>49041</b>	1/2" x 15 Ø	25	8435195806021	<b>1,59</b>
<b>49042</b>	1/2" x 18 Ø	25	8435195806038	<b>1,93</b>
<b>49043</b>	1/2" x 22 Ø	25	8435195806045	<b>2,76</b>
<b>49044</b>	3/4" x 18 Ø	25	8435195806052	<b>2,85</b>
<b>49045</b>	3/4" x 22 Ø	25	8435195806069	<b>3,76</b>
<b>49048</b>	3/4" x 28 Ø	10	8435195806076	<b>5,68</b>
<b>49049</b>	1" x 22 Ø	10	8435195821246	<b>4,98</b>
<b>49046</b>	1" x 28 Ø	10	8435195806083	<b>5,26</b>
<b>49025</b>	1 1/4" x 35 Ø	5	8435195821253	<b>11,10</b>
<b>49050</b>	1 1/2" x 42 Ø	5	8435195821260	<b>16,70</b>
<b>49051</b>	2" x 54 Ø	2	8435195821277	<b>30,86</b>

### TAPÓN LATÓN (310GCu)



Código	Medida	Caja	Código Barras	€ / Ud.
<b>49091</b>	12 Ø	25	8435195806458	<b>0,34</b>
<b>49092</b>	15 Ø	25	8435195806465	<b>0,62</b>
<b>49093</b>	18 Ø	25	8435195806472	<b>0,63</b>
<b>49094</b>	22 Ø	25	8435195806489	<b>0,80</b>









### CURVA DESVIACIÓN (85GCu)



Código	Medida	Caja	Código Barras	€ / Ud.
<b>99360</b>	15 x 15 Ø	10	8435195806496	<b>5,18</b>
<b>99707</b>	18 x 18 Ø	10	8435195806502	<b>5,72</b>
<b>98051</b>	22 x 22 Ø	10	8435195806519	<b>8,98</b>



## RACORERÍA DE LATÓN PARA RIEGO

<b>Lanza manguera 3 efectos</b>		<b>194</b>
<b>Entronques, manguitos y te manguera</b>		<b>194</b>
<b>Racor manguera 2 piezas</b>		<b>195</b>
<b>Colzadas riego y juntas</b>		<b>195</b>
<b>Válvula esfera riego</b>		<b>195</b>
<b>Racor rápido "Barcelona" y juntas</b>		<b>196</b>
<b>Te M, Te H, Te lisa</b>		<b>197</b>
<b>Boquillas</b>		<b>197</b>

## RACORERÍA DE LATÓN PARA RIEGO



### LANZA MANGUERA 3 EFECTOS



Código	Medida	Caja	Código Barras	€ / Ud.
<b>99122</b>	16 mm. Ø	1	8435195822922	<b>9,22</b>
<b>99123</b>	20 mm. Ø	1	8435195822939	<b>9,76</b>
<b>99124</b>	25 mm. Ø	1	8435195822946	<b>11,10</b>

### ENTRONQUE MANGUERA MACHO



Código	Medida	Caja	Código Barras	€ / Ud.
<b>69530</b>	3/8" x 13 mm.	25	8435195811247	<b>1,37</b>
<b>69531</b>	1/2" x 17 mm.	25	8435195811254	<b>1,43</b>
<b>69532</b>	3/4" x 22 mm.	25	8435195811261	<b>1,89</b>
<b>69533</b>	1" x 29 mm.	10	8435195811278	<b>2,57</b>
<b>69534</b>	1 1/4" x 34 mm.	5	8435195811285	<b>4,55</b>
<b>69535</b>	1 1/2" x 43 mm.	5	8435195811292	<b>7,25</b>
<b>69536</b>	2" x 59 mm.	1	8435195811308	<b>11,04</b>
<b>69560</b>	2 1/2" x 56 mm.	1	8435195827408	<b>15,10</b>
<b>69537</b>	3" x 75 mm.	1	8435195811315	<b>30,52</b>
<b>69561</b>	4" x 102 mm.	1	8435195827415	<b>63,00</b>

### ENTRONQUE MANGUERA MACHO REFORZADO



Código	Medida	Caja	Código Barras	€ / Ud.
<b>69562</b>	1" x 27 mm.	10	8435195842067	<b>3,62</b>
<b>69554</b>	1 1/4" x 38 mm.	5	8435195842036	<b>5,63</b>
<b>69555</b>	1 1/2" x 43 mm.	5	8435195842043	<b>9,89</b>
<b>69563</b>	2" x 50 mm.	1	8435195842074	<b>18,90</b>
<b>69556</b>	2" x 57 mm.	1	8435195842050	<b>14,93</b>

### MANGUITO EMPALME MANGUERA



Código	Medida	Caja	Código Barras	€ / Ud.
<b>99111</b>	3/8"	10	8435195817119	<b>3,52</b>
<b>99112</b>	1/2"	10	8435195817126	<b>4,89</b>
<b>99113</b>	3/4"	10	8435195817133	<b>5,96</b>
<b>99114</b>	1"	10	8435195817140	<b>10,31</b>
<b>99115</b>	1 1/4"	10	8435195817157	<b>16,86</b>

### TE EMPALME MANGUERA

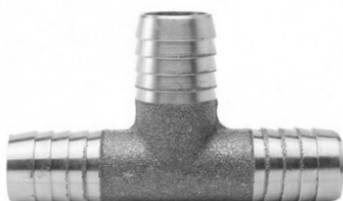

Código	Medida	Caja	Código Barras	€ / Ud.
<b>99118</b>	3/8"	10	8435195817164	<b>3,98</b>
<b>99119</b>	1/2"	10	8435195817171	<b>5,70</b>
<b>99120</b>	3/4"	10	8435195817188	<b>7,64</b>
<b>99121</b>	1"	10	8435195817195	<b>16,61</b>

## RACORERÍA DE LATÓN PARA RIEGO



### RACOR MANGUERA 2 PIEZAS



Código	Medida	Caja	Código Barras	€ / Ud.
<b>69801</b>	3/8"	25	8435195821413	<b>3,16</b>
<b>69802</b>	1/2"	25	8435195811322	<b>1,59</b>
<b>69803</b>	3/4"	25	8435195811339	<b>2,18</b>
<b>69804</b>	1"	5	8435195811346	<b>3,40</b>
<b>69805</b>	1 1/4"	5	8435195811353	<b>9,53</b>
<b>69806</b>	1 1/2"	2	8435195811360	<b>10,96</b>
<b>69807</b>	2"	2	8435195811377	<b>14,46</b>

### COLZADA RIEGO TIPO "MADRID"



Código	Descripción	Caja	Código Barras	€ / Ud.
<b>48092</b>	Curva	10	8435195805727	<b>99,98</b>

Código	Descripción	Caja	Código Barras	€ / Ud.
<b>48091</b>	Recta	10	8435195805710	<b>87,75</b>

### JUNTA COLZADA RIEGO



Código	Medida	Caja	Código Barras	€ / Ud.
<b>48093</b>	Única	10	8435195805734	<b>1,18</b>

### VÁLVULA ESFERA RIEGO



Código	Medida	Caja	Código Barras	€ / Ud.
<b>990111</b>	M 1/2" x H 3/8"	100	8435195817102	<b>5,37</b>

## RACORERÍA DE LATÓN PARA RIEGO



### RACOR RÁPIDO MACHO TIPO "BARCELONA"



Código	Medida	Caja	Código Barras	€ / Ud.
<b>69621</b>	M 1/2" x M 1/2"	10	8435195823103	<b>3,70</b>
<b>69622</b>	M 3/4" x M 3/4"	10	8435195823110	<b>5,96</b>
<b>69623</b>	M 1" x M 1"	5	8435195823127	<b>7,82</b>
<b>69624</b>	M 1 1/4" x M 1 1/4"	5	8435195823134	<b>14,99</b>
<b>69625</b>	M 1 1/2" x M 1 1/2"	2	8435195823141	<b>25,67</b>
<b>69626</b>	M 2" x M 2"	2	8435195823158	<b>39,98</b>

### RACOR RÁPIDO MANGUERA TIPO "BARCELONA"



Código	Medida	Caja	Código Barras	€ / Ud.
<b>69611</b>	20 x 20 Ø	10	8435195823011	<b>4,80</b>
<b>69612</b>	25 x 25 Ø	10	8435195823028	<b>7,08</b>
<b>69613</b>	32 x 32 Ø	5	8435195823035	<b>9,51</b>
<b>69614</b>	35 x 35 Ø	5	8435195823042	<b>17,49</b>
<b>69615</b>	40 x 40 Ø	2	8435195823059	<b>25,45</b>
<b>69616</b>	45 x 45 Ø	2	8435195823066	<b>30,72</b>
<b>69617</b>	50 x 50 Ø	2	8435195823073	<b>28,75</b>
<b>69618</b>	60 x 60 Ø	2	8435195823080	<b>46,40</b>
<b>69619</b>	70 x 70 Ø	1	8435195823097	<b>75,60</b>

### RACOR RÁPIDO MACHO - MANGUERA TIPO "BARCELONA"



Código	Medida	Caja	Código Barras	€ / Ud.
<b>69601</b>	1/2" x 20 Ø	10	8435195822953	<b>4,38</b>
<b>69602</b>	3/4" x 25 Ø	10	8435195822960	<b>6,39</b>
<b>69603</b>	1" x 30 Ø	5	8435195822977	<b>8,93</b>
<b>69604</b>	1 1/4" x 35 Ø	5	8435195822984	<b>15,74</b>
<b>69605</b>	1 1/2" x 45 Ø	2	8435195822991	<b>26,91</b>
<b>69606</b>	2" x 60 Ø	2	8435195823004	<b>43,90</b>

### JUNTA CAUCHO RACOR TIPO "BARCELONA"



Código	Medida	Caja	Código Barras	€ / Ud.
<b>69631</b>	20 mm.	25	8435195825053	<b>0,47</b>
<b>69632</b>	25 mm.	25	8435195825060	<b>0,36</b>
<b>69633</b>	30 mm.	25	8435195825077	<b>0,38</b>
<b>69634</b>	35 mm.	10	8435195825084	<b>0,59</b>
<b>69635</b>	40 mm.	10	8435195825091	<b>0,62</b>
<b>69636</b>	45 mm.	10	8435195825107	<b>0,67</b>
<b>69637</b>	50 mm.	5	8435195825114	<b>0,78</b>
<b>69638</b>	60 mm.	5	8435195825121	<b>1,28</b>
<b>69639</b>	70 mm.	5	8435195825138	<b>1,28</b>

# RACORERÍA DE LATÓN PARA RIEGO



## TE MACHO



Código	Medida	Caja	Código Barras	€ / Ud.
<b>990100</b>	3/8" x 10 mm.	25	8435195816990	<b>3,08</b>

## TE HEMBRA



Código	Medida	Caja	Código Barras	€ / Ud.
<b>990101</b>	1/4" x 10 mm.	10	8435195817164	<b>3,98</b>

## TE LISA



Código	Medida	Caja	Código Barras	€ / Ud.
<b>990102</b>	10 mm. Ø	25	8435195817010	<b>3,30</b>

## BOQUILLA MACHO



Código	Medida	Caja	Código Barras	€ / Ud.
<b>990103</b>	1/4"	50	8435195817027	<b>0,95</b>
<b>990104</b>	3/8"	50	8435195817034	<b>1,79</b>
<b>990105</b>	1/2"	50	8435195817041	<b>1,99</b>

## BOQUILLA LISA



Código	Medida	Caja	Código Barras	€ / Ud.
<b>990106</b>	8 mm. Ø	50	8435195817058	<b>1,45</b>
<b>990107</b>	10 mm. Ø	50	8435195817065	<b>1,49</b>

## BOQUILLA RACOR LOCO



Código	Medida	Caja	Código Barras	€ / Ud.
<b>990108</b>	8 mm. Ø	50	8435195817072	<b>1,74</b>
<b>990109</b>	10 mm. Ø	50	8435195817089	<b>1,75</b>

## TUERCA RACOR LOCO



Código	Medida	Caja	Código Barras	€ / Ud.
<b>990110</b>	1/2"	50	8435195817096	<b>0,56</b>







## NIPPELS GALVANIZADOS

**Nippels galvanizados**



**200**

## NIPPELS GALVANIZADOS



**ROSCA EN AMBOS EXTREMOS**

**ROSCA CÓNICA ISO 7/1 (EN 10226-1) DIN 2982 (EN 10241)**

### NIPPEL GALVANIZADO 1/4"

**1/4"**

Código	Medida	Caja	Código Barras	€ / Ud.
<b>80101</b>	1/4" x 40 mm.	10	8435195812787	<b>1,48</b>
<b>80102</b>	1/4" x 60 mm.	10	8435195812794	<b>1,11</b>
<b>80103</b>	1/4" x 80 mm.	10	8435195812800	<b>1,22</b>
<b>80104</b>	1/4" x 100 mm.	10	8435195812817	<b>1,29</b>

### NIPPEL GALVANIZADO 3/8"

**3/8"**

Código	Medida	Caja	Código Barras	€ / Ud.
<b>99030</b>	3/8" x 40 mm.	10	8435195812824	<b>1,12</b>
<b>80020</b>	3/8" x 60 mm.	10	8435195812831	<b>1,48</b>
<b>98031</b>	3/8" x 80 mm.	10	8435195812848	<b>1,62</b>
<b>82021</b>	3/8" x 100 mm.	10	8435195812855	<b>1,66</b>
<b>98025</b>	3/8" x 120 mm.	10	8435195812862	<b>1,76</b>
<b>82022</b>	3/8" x 160 mm.	10	8435195812879	<b>2,56</b>
<b>82024</b>	3/8" x 200 mm.	10	8435195812886	<b>2,66</b>
<b>82029</b>	3/8" x 300 mm.	10	8435195812893	<b>3,96</b>
<b>98026</b>	3/8" x 500 mm.	10	8435195812909	<b>6,84</b>

### NIPPEL GALVANIZADO 1/2"

**1/2"**

Código	Medida	Caja	Código Barras	€ / Ud.
<b>80001</b>	1/2" x 40 mm.	10	8435195812916	<b>1,06</b>
<b>80002</b>	1/2" x 60 mm.	10	8435195812923	<b>1,28</b>
<b>80003</b>	1/2" x 80 mm.	10	8435195812930	<b>1,48</b>
<b>80004</b>	1/2" x 100 mm.	10	8435195812947	<b>1,48</b>
<b>80005</b>	1/2" x 120 mm.	10	8435195812954	<b>1,81</b>
<b>80006</b>	1/2" x 140 mm.	10	8435195812961	<b>1,81</b>
<b>80007</b>	1/2" x 160 mm.	10	8435195812978	<b>2,14</b>
<b>80008</b>	1/2" x 180 mm.	10	8435195812985	<b>2,39</b>
<b>80009</b>	1/2" x 200 mm.	10	8435195812992	<b>2,39</b>
<b>80010</b>	1/2" x 250 mm.	10	8435195813005	<b>3,38</b>
<b>80011</b>	1/2" x 300 mm.	10	8435195813012	<b>3,71</b>
<b>80016</b>	1/2" x 400 mm.	10	8435195813029	<b>4,53</b>
<b>80012</b>	1/2" x 500 mm.	10	8435195813036	<b>4,53</b>
<b>80017</b>	1/2" x 600 mm.	10	8435195822175	<b>6,73</b>
<b>80013</b>	1/2" x 1000 mm.	10	8435195822182	<b>10,85</b>

**Nota: Se puede fabricar cualquier medida de su interés bajo pedido**

## NIPPELS GALVANIZADOS



**ROSCA EN AMBOS EXTREMOS**  
**ROSCA CÓNICA ISO 7/1 (EN 10226-1) DIN 2982 (EN 10241)**

### NIPPEL GALVANIZADO 3/4"

**3/4"**

Código	Medida	Caja	Código Barras	€ / Ud.
<b>80501</b>	3/4" x 40 mm.	10	8435195813043	<b>1,46</b>
<b>80502</b>	3/4" x 60 mm.	10	8435195813050	<b>1,48</b>
<b>80503</b>	3/4" x 80 mm.	10	8435195813067	<b>1,56</b>
<b>80504</b>	3/4" x 100 mm.	10	8435195813074	<b>2,14</b>
<b>80505</b>	3/4" x 120 mm.	10	8435195813081	<b>2,15</b>
<b>80506</b>	3/4" x 140 mm.	10	8435195813098	<b>2,47</b>
<b>80507</b>	3/4" x 160 mm.	10	8435195813104	<b>2,64</b>
<b>80508</b>	3/4" x 180 mm.	10	8435195813111	<b>2,64</b>
<b>80509</b>	3/4" x 200 mm.	10	8435195813128	<b>2,97</b>
<b>80510</b>	3/4" x 250 mm.	10	8435195813135	<b>3,49</b>
<b>80511</b>	3/4" x 300 mm.	10	8435195813142	<b>4,53</b>
<b>80515</b>	3/4" x 400 mm.	10	8435195813159	<b>5,20</b>
<b>80516</b>	3/4" x 500 mm.	10	8435195813166	<b>6,93</b>

### NIPPEL GALVANIZADO 1"

**1"**

Código	Medida	Caja	Código Barras	€ / Ud.
<b>81001</b>	1" x 40 mm.	10	8435195813173	<b>1,58</b>
<b>81002</b>	1" x 60 mm.	10	8435195813180	<b>1,98</b>
<b>81003</b>	1" x 80 mm.	10	8435195813197	<b>2,31</b>
<b>81004</b>	1" x 100 mm.	10	8435195813203	<b>2,55</b>
<b>81005</b>	1" x 120 mm.	10	8435195813210	<b>2,97</b>
<b>81006</b>	1" x 140 mm.	10	8435195813227	<b>3,13</b>
<b>81007</b>	1" x 160 mm.	10	8435195813234	<b>3,55</b>
<b>81008</b>	1" x 180 mm.	10	8435195813241	<b>3,87</b>
<b>81009</b>	1" x 200 mm.	10	8435195813258	<b>4,24</b>
<b>81010</b>	1" x 250 mm.	10	8435195813265	<b>5,44</b>
<b>81011</b>	1" x 300 mm.	10	8435195813272	<b>6,35</b>
<b>81014</b>	1" x 400 mm.	10	8435195813289	<b>8,16</b>
<b>81013</b>	1" x 500 mm.	10	8435195813296	<b>10,31</b>

### NIPPEL GALVANIZADO 1 1/4"

**1 1/4"**

Código	Medida	Caja	Código Barras	€ / Ud.
<b>81501</b>	1 1/4" x 60 mm.	10	8435195813302	<b>2,56</b>
<b>81502</b>	1 1/4" x 80 mm.	10	8435195813319	<b>2,72</b>
<b>81503</b>	1 1/4" x 100 mm.	10	8435195813326	<b>2,14</b>
<b>81504</b>	1 1/4" x 120 mm.	10	8435195813333	<b>3,54</b>
<b>81505</b>	1 1/4" x 140 mm.	10	8435195813340	<b>3,88</b>
<b>81506</b>	1 1/4" x 160 mm.	10	8435195813357	<b>4,45</b>
<b>81507</b>	1 1/4" x 180 mm.	10	8435195813364	<b>4,99</b>
<b>81508</b>	1 1/4" x 200 mm.	10	8435195813371	<b>5,53</b>
<b>81509</b>	1 1/4" x 250 mm.	10	8435195813388	<b>6,68</b>
<b>81510</b>	1 1/4" x 300 mm.	10	8435195813395	<b>7,92</b>
<b>81514</b>	1 1/4" x 400 mm.	10	8435195813401	<b>9,36</b>
<b>81512</b>	1 1/4" x 500 mm.	10	8435195813418	<b>11,44</b>

**Nota: Se puede fabricar cualquier medida de su interés bajo pedido**

# NIPPELS GALVANIZADOS



ROSCA EN AMBOS EXTREMOS  
ROSCA CÓNICA ISO 7/1 (EN 10226-1) DIN 2982 (EN 10241)

## NIPPEL GALVANIZADO 1 1/2"

1 1/2"

Código	Medida	Caja	Código Barras	€ / Ud.
82001	1 1/2" x 60 mm.	10	8435195813425	2,72
82002	1 1/2" x 80 mm.	10	8435195813432	3,21
82003	1 1/2" x 100 mm.	10	8435195813449	3,63
82004	1 1/2" x 120 mm.	10	8435195813456	4,29
82005	1 1/2" x 140 mm.	10	8435195813463	4,99
82006	1 1/2" x 160 mm.	10	8435195813470	5,61
82007	1 1/2" x 180 mm.	10	8435195813487	6,35
82008	1 1/2" x 200 mm.	10	8435195813494	6,68
82009	1 1/2" x 250 mm.	10	8435195813500	8,16
82010	1 1/2" x 300 mm.	10	8435195813517	9,65
82013	1 1/2" x 400 mm.	10	8435195813524	11,95
82012	1 1/2" x 500 mm.	10	8435195813531	15,84

## NIPPEL GALVANIZADO 2"

2"

Código	Medida	Caja	Código Barras	€ / Ud.
82501	2" x 60 mm.	10	8435195813548	3,86
82502	2" x 80 mm.	10	8435195813555	3,06
82503	2" x 100 mm.	10	8435195813562	3,96
82504	2" x 120 mm.	10	8435195813579	5,61
82505	2" x 140 mm.	10	8435195813586	5,61
82506	2" x 160 mm.	10	8435195813609	6,33
82507	2" x 180 mm.	10	8435195813616	7,59
82508	2" x 200 mm.	10	8435195813623	8,49
82509	2" x 250 mm.	10	8435195813630	9,97
82510	2" x 300 mm.	10	8435195813647	11,57
82513	2" x 400 mm.	10	8435195813654	16,25
82511	2" x 500 mm.	10	8435195813661	19,49

## NIPPEL GALVANIZADO 2 1/2"

2 1/2"

Código	Medida	Caja	Código Barras	€ / Ud.
82520	2 1/2" x 100 mm.	10	8435195813678	7,28
82521	2 1/2" x 120 mm.	10	8435195813685	7,58
82522	2 1/2" x 160 mm.	10	8435195813692	9,89
82523	2 1/2" x 200 mm.	10	8435195813708	11,95
82524	2 1/2" x 300 mm.	10	8435195813715	16,65
82525	2 1/2" x 500 mm.	10	8435195813722	25,89

## NIPPEL GALVANIZADO 3"

3"

Código	Medida	Caja	Código Barras	€ / Ud.
82530	3" x 100 mm.	10	8435195813739	9,57
82531	3" x 120 mm.	10	8435195813746	10,88
82532	3" x 160 mm.	10	8435195813753	13,11
82533	3" x 200 mm.	10	8435195813760	15,84
82534	3" x 300 mm.	10	8435195813777	22,85
82535	3" x 500 mm.	10	8435195813784	52,22

Nota: Se puede fabricar cualquier medida de su interés bajo pedido



## VÁLVULAS DE FUNDICIÓN

<b>Racores Unión</b>		<b>204</b>
<b>Abrazaderas de reparación</b>		<b>205</b>
<b>Conexiones manguera</b>		<b>206</b>
<b>Manguitos antivibratorios</b>		<b>206</b>



## VÁLVULAS DE FUNDICIÓN

Hierro galvanizado

### RACOR UNIÓN MACHO A TUBO fundición maleable



Código	Medida	Caja	Código Barras	€ / Ud.
<b>82901</b>	M 1/2" x 21,3 mm.	5	8435195827576	<b>12,16</b>
<b>82902</b>	M 3/4" x 26,9 mm.	5	8435195827583	<b>15,56</b>
<b>82903</b>	M 1" x 33,7 mm.	5	8435195827590	<b>15,81</b>
<b>82904</b>	M 1 1/4" x 42,4 mm.	1	8435195833867	<b>21,58</b>
<b>82905</b>	M 1 1/2" x 48,3 mm.	1	8435195833874	<b>28,26</b>
<b>82906</b>	M 2" x 60,3 mm.	1	8435195833881	<b>39,72</b>
<b>82907</b>	M 2 1/2" x 76,1 mm.	1	8435195843859	<b>71,03</b>

### RACOR UNIÓN HEMBRA A TUBO fundición maleable



Código	Medida	Caja	Código Barras	€ / Ud.
<b>82915</b>	H 1/2" x 21,3 mm.	5	8435195827606	<b>12,30</b>
<b>82916</b>	H 3/4" x 26,9 mm.	5	8435195827613	<b>13,80</b>
<b>82917</b>	H 1" x 33,7 mm.	5	8435195827620	<b>15,40</b>
<b>82918</b>	H 1 1/4" x 42,4 mm.	1	8435195833898	<b>23,35</b>
<b>82919</b>	H 1 1/2" x 48,3 mm.	1	8435195833904	<b>28,42</b>
<b>82920</b>	H 2" x 60,3 mm.	1	8435195833911	<b>41,72</b>

### RACOR UNIÓN TUBO A TUBO fundición maleable



Código	Medida	Caja	Código Barras	€ / Ud.
<b>82925</b>	3/8" x 17,2 mm.	5	8435195843873	<b>18,83</b>
<b>82926</b>	1/2" x 21,3 mm.	5	8435195827637	<b>16,52</b>
<b>82927</b>	3/4" x 26,9 mm.	5	8435195827644	<b>19,20</b>
<b>82928</b>	1" x 33,7 mm.	5	8435195827651	<b>22,11</b>
<b>82929</b>	1 1/4" x 42,4 mm.	1	8435195833928	<b>29,45</b>
<b>82930</b>	1 1/2" x 48,3 mm.	1	8435195833935	<b>38,47</b>
<b>82931</b>	2" x 60,3 mm.	1	8435195833942	<b>59,90</b>

# VÁLVULAS DE FUNDICIÓN

Hierro galvanizado



## ABRAZADERA REPARACIÓN CORTA fundición maleable



Código	Medida	Caja	Código Barras	€ / Ud.
<b>82971</b>	1/2"	5	8435195827668	<b>7,27</b>
<b>82972</b>	3/4"	5	8435195827675	<b>7,95</b>
<b>82973</b>	1"	5	8435195827682	<b>10,49</b>
<b>82974</b>	1 1/4"	5	8435195827699	<b>13,25</b>
<b>82975</b>	1 1/2"	5	8435195827705	<b>16,10</b>
<b>82976</b>	2"	5	8435195827712	<b>21,86</b>
<b>82978</b>	3"	5	8435195843880	<b>55,96</b>

- Abrazaderas de fundición maleable para tubos de PE.
- Impermeabilización y reparación de fisuras y poros en tuberías de PE, PVC y otras.

## ABRAZADERA REPARACIÓN LARGA fundición maleable



Código	Medida	Caja	Código Barras	€ / Ud.
<b>82981</b>	1/2"	5	8435195843897	<b>16,07</b>
<b>82982</b>	3/4"	5	8435195843903	<b>17,36</b>
<b>82983</b>	1"	5	8435195843910	<b>19,65</b>

- Abrazaderas de fundición maleable para tubos de PE.
- Impermeabilización y reparación de fisuras y poros en tuberías de PE, PVC y otras.

## ABRAZADERA REPARACIÓN TAPAPOROS COBRE



Código	Medida	Caja	Código Barras	€ / Ud.
<b>83124</b>	15 mm.	5	8435195827729	<b>11,47</b>
<b>83126</b>	18 mm.	5	8435195827736	<b>11,89</b>
<b>83127</b>	22 mm.	5	8435195827743	<b>14,72</b>
<b>83128</b>	28 mm.	5	8435195827750	<b>20,26</b>

- Abrazaderas de unión para tubo de cobre.
- Tapaporos y derivaciones en latón.

## ABRAZADERA REPARACIÓN TAPAPOROS CON TOMA COBRE



Código	Medida	Caja	Código Barras	€ / Ud.
<b>83141</b>	1/2" x 18 mm.	5	8435195844436	<b>17,93</b>
<b>83142</b>	1/2" x 22 mm.	5	8435195844443	<b>18,88</b>
<b>83143</b>	3/4" x 28 mm.	5	8435195844450	<b>26,38</b>

- Abrazaderas de unión para tubo de cobre.
- Tapaporos y derivaciones en latón.



## VÁLVULAS DE FUNDICIÓN

Hierro galvanizado

### CONEXIÓN MANGUERA



Código	Medida	Caja	Código Barras	€ / Ud.
<b>82801</b>	3/8" x 100 mm.	10	8435195822755	<b>1,64</b>
<b>82802</b>	1/2" x 100 mm.	10	8435195822762	<b>1,89</b>
<b>82803</b>	3/4" x 100 mm.	10	8435195822779	<b>2,31</b>
<b>82804</b>	1" x 100 mm.	10	8435195822786	<b>3,44</b>
<b>82805</b>	1 1/4" x 100 mm.	5	8435195822793	<b>4,27</b>
<b>82806</b>	1 1/2" x 100 mm.	5	8435195822809	<b>5,32</b>
<b>82807</b>	2" x 100 mm.	2	8435195822816	<b>7,20</b>
<b>82808</b>	2 1/2" x 100 mm.	1	8435195822823	<b>11,30</b>
<b>82809</b>	3" x 100 mm.	1	8435195822830	<b>18,63</b>

### MANGUITO ANTIVIBRATORIO DOBLE ONDA



Código	Medida	Caja	Código Barras	€ / Ud.
<b>82562</b>	3/4"	1	8435195825213	<b>17,43</b>
<b>82563</b>	1"	1	8435195825220	<b>21,93</b>
<b>82564</b>	1 1/4"	1	8435195825237	<b>26,98</b>
<b>82565</b>	1 1/2"	1	8435195825244	<b>38,65</b>
<b>82566</b>	2"	1	8435195825251	<b>46,43</b>
<b>82567</b>	2 1/2"	1	8435195827521	<b>72,96</b>
<b>82568</b>	3"	1	8435195827538	<b>96,30</b>

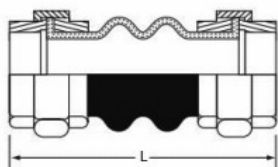





## CALEFACCIÓN

<b>Purgadores automáticos</b>		<b>208</b>
<b>Purgadores manuales</b>		<b>209</b>
<b>Válvulas de seguridad y retención</b>		<b>209</b>
<b>Válvulas y detentores manuales para radiador</b>		<b>210</b>
<b>Válvulas termostaticables para radiador</b>		<b>212</b>
<b>Colectores</b>		<b>213</b>
<b>Complementos colectores</b>		<b>214</b>
<b>Termostatos y cronotermostatos</b>		<b>215</b>
<b>Tuercas</b>		<b>216</b>
<b>Florones y tapones</b>		<b>217</b>
<b>Soportes de radiador y casquillos</b>		<b>218</b>



## CALEFACCIÓN

*Purgadores automáticos de aire*

### PURGADOR AUTOMÁTICO DE AIRE salida superior



Código	Medida	Caja	Código Barras	€ / Ud.
<b>90040</b>	3/8"	20	8435195816808	<b>6,83</b>
<b>90041</b>	1/2"	20	8435195816815	<b>6,98</b>

### PURGADOR AUTOMÁTICO DE AIRE salida lateral



Código	Medida	Caja	Código Barras	€ / Ud.
<b>90045</b>	3/8"	10	8435195816822	<b>6,63</b>
<b>90046</b>	1/2"	10	8435195816839	<b>6,68</b>

### PURGADOR AUTOMÁTICO DE AIRE toma lateral



Código	Medida	Caja	Código Barras	€ / Ud.
<b>90049</b>	3/8"	10	8435195816846	<b>7,81</b>
<b>90050</b>	1/2"	10	8435195816853	<b>7,96</b>

### VÁLVULA RETENCIÓN PARA PURGADOR AUTOMÁTICO



Código	Medida	Caja	Código Barras	€ / Ud.
<b>90053</b>	3/8"	20	8435195816860	<b>1,15</b>
<b>90054</b>	1/2"	20	8435195816877	<b>1,60</b>

### CARACTERÍSTICAS TÉCNICAS

- Cuerpo y tapa de latón UNI EN 12165.
- Flotador: PP.
- Vástago del obturador de latón UNI EN 12165.
- Muelle: acero inoxidable.
- EPDM.
- Uso para fluidos de agua y solución de glicol.
- Máximo porcentaje de glicol: 30%.
- Presión máxima de trabajo: 10 bar.
- Presión máxima de descarga: de 2,5 a 4 bar.
- Temperatura máxima de trabajo: 110°C - 120°C.

## PURGADOR MANUAL DE AIRE PARA RADIADOR



Código	Medida	Caja	Código Barras	€ / Ud.
<b>90057</b>	1/8"	20	8435195816884	<b>1,12</b>
<b>90058</b>	1/4"	20	8435195816891	<b>0,88</b>
<b>90059</b>	3/8"	20	8435195816907	<b>1,28</b>
<b>90060</b>	1/2"	20	8435195816914	<b>1,86</b>

## PURGADOR AUTOMÁTICO DE AIRE PARA RADIADOR



	Código	Medida	Caja	Código Barras	€ / Ud.
<b>Izquierda</b>	<b>90070</b>	1"	10	8435195816921	<b>8,69</b>
	<b>90071</b>	1 1/4"	10	8435195816938	<b>8,69</b>
<b>Derecha</b>	<b>90072</b>	1"	10	8435195816945	<b>8,69</b>
	<b>90073</b>	1 1/4"	10	8435195816952	<b>8,69</b>

## VÁLVULA DE SEGURIDAD SIN SISTEMA DE RETENCIÓN



Código	Medida	Caja	Código Barras	€ / Ud.
<b>90074</b>	1/2"	50	8435195845174	<b>3,20</b>

## VÁLVULA DE SEGURIDAD Y RETENCIÓN PARA TERMO



	Código	Medida	Caja	Código Barras	€ / Ud.
<b>Sin palanca</b>	<b>90075</b>	3/8"	50	8435195816969	<b>3,10</b>
	<b>99506</b>	1/2"	50	8435195815344	<b>3,25</b>
	<b>90077</b>	3/4"	50	8435195816983	<b>7,96</b>



	Código	Medida	Caja	Código Barras	€ / Ud.
<b>Con palanca</b>	<b>90076</b>	1/2" 8 Bares	50	8435195816976	<b>4,12</b>
	<b>90079</b>	1/2" 10 Bares	50	8435195827545	<b>4,26</b>
	<b>90078</b>	3/4" 8 Bares	50	8435195822748	<b>7,85</b>
	<b>90098</b>	3/4" 10 Bares	50	8435195845181	<b>8,31</b>

- Cuerpo de latón UNI EN 12165 cromado.
- Muelle: acero inoxidable 316,
- Rosca M/H.

## DISPOSITIVO ANTIGOTEO PARA VÁLVULA DE SEGURIDAD



Código	Medida	Caja	Código Barras	€ / Ud.
<b>90065</b>	1/2"	10	8435195828177	<b>5,96</b>

## CALEFACCIÓN

### Válvulas y detentores manuales para radiador



#### VÁLVULA ESCUADRA M-M

	Código	Medida	Caja	Código Barras	€ / Ud.
Sin juntas	<b>90080</b>	3/8"	25	8435195823967	<b>8,25</b>
	<b>90081</b>	1/2"	25	8435195823974	<b>8,82</b>

	Código	Medida	Caja	Código Barras	€ / Ud.
Con juntas	<b>90082</b>	3/8"	25	8435195823981	<b>7,26</b>
	<b>90083</b>	1/2"	25	8435195823998	<b>8,96</b>



- Regulación manual.
- Cuerpo y tuerca en latón UNI EN 12165 niquelado.
- Obturador y racor en latón UNI EN 12164.
- Junta de estanqueidad obturador en EPDM.
- Volante en ABS blanco.
- Junta de estanqueidad racor en NBR.
- Presión máxima de ejercicio: 10 bar. / Presión diferencial máxima: 6 bar.

#### DETENTOR VÁLVULA ESCUADRA M-M

	Código	Medida	Caja	Código Barras	€ / Ud.
Sin juntas	<b>90084</b>	3/8"	25	8435195824001	<b>5,50</b>
	<b>90085</b>	1/2"	25	8435195824018	<b>6,82</b>

	Código	Medida	Caja	Código Barras	€ / Ud.
Con juntas	<b>90086</b>	3/8"	25	8435195824025	<b>7,71</b>
	<b>90087</b>	1/2"	25	8435195824032	<b>7,35</b>



- Regulación manual.
- Cuerpo y tuerca en latón UNI EN 12165 niquelado.
- Obturador, racor y anillo en latón UNI EN 12164.
- Junta de estanqueidad obturador en EPDM.
- Junta superior de estanqueidad obturador en EPDM.
- Capucha en ABS blanco.
- Junta de estanqueidad racor en NBR.
- Presión máxima de ejercicio: 10 bar. / Presión diferencial máxima: 6 bar.

## CALEFACCIÓN

Válvulas y detentores manuales para radiador



### VÁLVULA ESCUADRA M-H

	Código	Medida	Caja	Código Barras	€ / Ud.
Sin juntas	<b>90088</b>	3/8"	25	8435195824049	<b>7,96</b>
	<b>90089</b>	1/2"	25	8435195824056	<b>8,09</b>

	Código	Medida	Caja	Código Barras	€ / Ud.
Con juntas	<b>90090</b>	3/8"	25	8435195824063	<b>8,37</b>
	<b>90093</b>	1/2"	25	8435195824070	<b>8,60</b>



- Regulación manual.
- Cuerpo y tuerca en latón UNI EN 12165 niquelado.
- Obturador y racor en latón UNI EN 12164.
- Junta de estanqueidad obturador en EPDM.
- Volante en ABS blanco.
- Junta de estanqueidad racor en NBR.
- Presión máxima de ejercicio: 10 bar. / Presión diferencial máxima: 6 bar.

### DETENTOR VÁLVULA ESCUADRA M-H

	Código	Medida	Caja	Código Barras	€ / Ud.
Sin juntas	<b>90094</b>	3/8"	25	8435195824087	<b>5,69</b>
	<b>90095</b>	1/2"	25	8435195824094	<b>7,11</b>

	Código	Medida	Caja	Código Barras	€ / Ud.
Con juntas	<b>90096</b>	3/8"	25	8435195824100	<b>6,67</b>
	<b>90097</b>	1/2"	25	8435195824117	<b>7,98</b>



- Regulación manual.
- Cuerpo y tuerca en latón UNI EN 12165 niquelado.
- Obturador, racor y anillo en latón UNI EN 12164.
- Junta de estanqueidad obturador en EPDM.
- Junta superior de estanqueidad obturador en EPDM.
- Capucha en ABS blanco.
- Junta de estanqueidad racor en NBR.
- Presión máxima de ejercicio: 10 bar. / Presión diferencial máxima: 6 bar.

## CALEFACCIÓN

### Válvulas termostaticables para radiador



#### VÁLVULA ESCUADRA M-M TERMOSTATIZABLE

	Código	Medida	Caja	Código Barras	€ / Ud.
Sin juntas	<b>90100</b>	3/8"	25	8435195824452	<b>9,25</b>
	<b>90101</b>	1/2"	25	8435195824469	<b>9,79</b>

	Código	Medida	Caja	Código Barras	€ / Ud.
Con juntas	<b>90102</b>	3/8"	25	8435195824476	<b>9,66</b>
	<b>90103</b>	1/2"	25	8435195824483	<b>10,40</b>



- Cuerpo y tuerca en latón UNI EN 12165 niquelado.
- Casquillo en PA6 (30% FV)
- Obturador, casquillo y arandela bloqueo de estanqueidad en latón UNI EN 12164.
- Junta de estanqueidad cuerpo obturador en NBR.
- Muelle en acero AISI 302.
- Eje en acero AISI 304.
- Junta de estanqueidad obturador en EPDM.
- Juntas obturador en NBR.
- Volante en ABS blanco.
- Tuerca y racor en latón UNI EN 12165 niquelado.
- Junta de estanqueidad racor en NBR.
- Presión máxima de ejercicio: 10 bar. / Presión diferencial máxima: 6 bar.
- Adaptable a cabezales termostáticos Sensor o cabezales termoelectricos.

#### VÁLVULA ESCUADRA M-H TERMOSTATIZABLE

	Código	Medida	Caja	Código Barras	€ / Ud.
Sin juntas	<b>90108</b>	3/8"	25	8435195824490	<b>9,57</b>
	<b>90109</b>	1/2"	25	8435195824506	<b>10,62</b>

	Código	Medida	Caja	Código Barras	€ / Ud.
Con juntas	<b>90110</b>	3/8"	25	8435195824513	<b>9,98</b>
	<b>90111</b>	1/2"	25	8435195824520	<b>11,20</b>



- Cuerpo y tuerca en latón UNI EN 12165 niquelado.
- Casquillo en PA6 (30% FV)
- Obturador, casquillo y arandela bloqueo de estanqueidad en latón UNI EN 12164.
- Junta de estanqueidad cuerpo obturador en NBR.
- Muelle en acero AISI 302.
- Eje en acero AISI 304.
- Junta de estanqueidad obturador en EPDM.
- Juntas obturador en NBR.
- Volante en ABS blanco.
- Tuerca y racor en latón UNI EN 12165 niquelado.
- Junta de estanqueidad racor en NBR.
- Presión máxima de ejercicio: 10 bar. / Presión diferencial máxima: 6 bar.
- Adaptable a cabezales termostáticos Sensor o cabezales termoelectricos.

# CALEFACCIÓN

## Colectores



### COLECTOR CON VÁLVULA M-H



Código	Medida	Caja	Código Barras	€ / Ud.
<b>90001</b>	3/4" 2 Vías	5	8435195823769	<b>19,52</b>
<b>90003</b>	3/4" 3 Vías	5	8435195823776	<b>27,61</b>
<b>90005</b>	3/4" 4 Vías	5	8435195823783	<b>36,42</b>

Código	Medida	Caja	Código Barras	€ / Ud.
<b>90002</b>	1" 2 Vías	5	8435195823790	<b>20,60</b>
<b>90004</b>	1" 3 Vías	5	8435195823806	<b>29,98</b>
<b>90006</b>	1" 4 Vías	5	8435195823813	<b>38,90</b>

- Cuerpo en latón UNI EN 12165 niquelado.
- Conexiones roscadas 24 x 19
- Volante en ABS blanco.
- Juntas NBR.
- Presión máxima de ejercicio: 10 bar.
- Temperatura máxima de ejercicio +110°C.

### COLECTOR M-H



Código	Medida	Caja	Código Barras	€ / Ud.
<b>90011</b>	3/4" 2 Vías	5	8435195823820	<b>6,75</b>
<b>90013</b>	3/4" 3 Vías	5	8435195823837	<b>9,31</b>
<b>90015</b>	3/4" 4 Vías	5	8435195823844	<b>12,38</b>

Código	Medida	Caja	Código Barras	€ / Ud.
<b>90012</b>	1" 2 Vías	5	8435195823851	<b>8,86</b>
<b>90014</b>	1" 3 Vías	5	8435195823868	<b>12,69</b>
<b>90016</b>	1" 4 Vías	5	8435195823875	<b>15,96</b>

- Cuerpo en latón UNI EN 12165 niquelado.
- Derivaciones roscas 24 x 19 con paso de Ø 14 mm.
- Junta entre los elementos NBR 70.
- Presión máxima de ejercicio: 10 bar.
- Temperatura máxima de ejercicio de 0°C a +110°C.

### COLECTOR H-H



Código	Medida	Caja	Código Barras	€ / Ud.
<b>90226</b>	1" x 1/2" x 114 2 Vías	5	8435195824889	<b>12,06</b>
<b>90228</b>	1" x 1/2" x 214 4 Vías	5	8435195824896	<b>23,25</b>
<b>90229</b>	1" x 1/2" x 264 5 Vías	5	8435195824902	<b>29,17</b>
<b>90230</b>	1" x 1/2" x 314 6 Vías	5	8435195824919	<b>34,47</b>
<b>90232</b>	1" x 1/2" x 414 8 Vías	5	8435195824926	<b>45,63</b>
<b>90234</b>	1" x 1/2" x 514 10 Vías	5	8435195824933	<b>59,21</b>

<b>90237</b>	1 1/4" x 1/2" x 220 4 Vías	5	8435195824940	<b>30,09</b>
<b>90239</b>	1 1/4" x 1/2" x 320 6 Vías	5	8435195824957	<b>47,53</b>
<b>90242</b>	1 1/4" x 1/2" x 470 9 Vías	5	8435195824964	<b>64,02</b>
<b>90243</b>	1 1/4" x 1/2" x 520 10 Vías	5	8435195824971	<b>69,75</b>
<b>90245</b>	1 1/4" x 1/2" x 620 12 Vías	5	8435195824988	<b>92,48</b>

<b>90252</b>	1 1/2" x 1" x 370 4 Vías	1	8435195833409	<b>169,52</b>
<b>90253</b>	1 1/2" x 1" x 570 6 Vías	1	8435495833416	<b>210,25</b>

# CALEFACCIÓN

## Complementos Colectores



### CAJA COLECTOR ABS "PLASTIBOX"

Código	Medida	Caja	Código Barras	€ / Ud.
<b>90031</b>	310 x 310 x 90	5	8435195823882	<b>21,08</b>
<b>90032</b>	460 x 310 x 90	5	8435195823899	<b>26,21</b>
<b>90033</b>	610 x 310 x 90	5	8435195823905	<b>33,34</b>



### PERFIL PARA CAJA COLECTOR "PLASTIBOX"

Código	Medida	Caja	Código Barras	€ / Ud.
<b>90036</b>	400 mm.	10	8435195823912	<b>15,55</b>



### SOPORTE PARA CAJA DE COLECTOR TIPO "CONTROLLER"

Código	Medida	Caja	Código Barras	€ / Ud.
<b>90034</b>	Colector 3/4"	10	8435195823929	<b>1,69</b>
<b>90035</b>	Colector 1"	10	8435195823936	<b>1,69</b>



### SOPORTE PARA CAJA DE COLECTOR TIPO "THERMODAY"

Código	Medida	Caja	Código Barras	€ / Ud.
<b>90037</b>	Colector 3/4"	10	8435195823943	<b>1,29</b>
<b>90038</b>	Colector 1"	10	8435195823950	<b>1,29</b>





## CALEFACCIÓN



### CABEZAL TERMOSTÁTICO CON SENSOR LÍQUIDO



Código	Medida	Caja	Código Barras	€ / Ud.
<b>90120</b>	3/8" x 1/2"	1	8435195824124	<b>14,48</b>

- Presión máxima de ejercicio: 10 Bar.
- Presión máxima diferencial: 1 Bar.
- Temperatura máxima ambiente: 40°C.
- Temperatura máxima agua instalación: 100°C.
- Campo de regulación: 7 - 28 °C.

### VÁLVULA MONOTUBO TERMOSTATIZABLE



Código	Medida	Caja	Código Barras	€ / Ud.
<b>90128</b>	1/2" Derecha	1	8435195824155	<b>28,10</b>

### CRONOTERMOSTATO ELECTRÓNICO SEMANAL



Código	Medida	Caja	Código Barras	€ / Ud.
<b>90135</b>	130 x 80 x 26	1	8435195824179	<b>54,40</b>

- Frontal transparente.

### CRONOTERMOSTATO ELECTRÓNICO SEMANAL



Código	Medida	Caja	Código Barras	€ / Ud.
<b>90136</b>	130 x 80 x 26	1	8435195824186	<b>44,80</b>

- Frontal negro.

### TERMOSTATO AMBIENTE MECÁNICO



Código	Medida	Caja	Código Barras	€ / Ud.
<b>90137</b>	90 x 90 x 40	1	8435195824193	<b>14,96</b>

## TUERCA MONOBLOC PARA TUBO DE COBRE



Código	Medida	Caja	Código Barras	€ / Ud.
<b>90140</b>	12 Ø	50	8435195824209	<b>2,56</b>
<b>90141</b>	14 Ø	50	8435195824216	<b>1,85</b>
<b>90142</b>	15 Ø	50	8435195824223	<b>2,45</b>
<b>90143</b>	16 Ø	50	8435195824230	<b>2,32</b>

- Presión máxima: 10 Bar.
- Temperatura máxima: 100°C.
- Niquelada.

## TUERCA MONOBLOC CON BICONO PARA TUBO DE COBRE



Código	Medida	Caja	Código Barras	€ / Ud.
<b>90146</b>	18 Ø	40	8435195824247	<b>2,27</b>

- Presión máxima: 10 Bar.
- Niquelada.

## TUERCA MONOBLOC PARA TUBO MULTICAPA



Código	Medida	Caja	Código Barras	€ / Ud.
<b>90150</b>	16 x 2	50	8435195824254	<b>3,48</b>
<b>90151</b>	16 x 2,25	50	8435195824261	<b>3,31</b>
<b>90152</b>	20 x 2	50	8435195824278	<b>3,31</b>
<b>90153</b>	20 x 2,50	40	8435195824285	<b>3,10</b>
<b>90154</b>	25 x 2,50	20	8435195824292	<b>5,54</b>

- Niquelada.
- Premontada.

## TUERCA MONOBLOC PARA PEX - POLIPROPILENO - POLIBUTILENO



Código	Medida	Caja	Código Barras	€ / Ud.
<b>90161</b>	16 x 2	40	8435195824308	<b>3,20</b>
<b>90162</b>	18 x 2	40	8435195824315	<b>3,20</b>
<b>90163</b>	20 x 2	40	8435195824322	<b>3,20</b>

- Niquelada.
- Premontada.

## CONJUNTO TUERCA Y MANGUITO RACOR COLECTOR



Código	Medida	Caja	Código Barras	€ / Ud.
<b>90170</b>	1/2" sin junta	10	8435195827552	<b>3,57</b>
<b>90171</b>	1/2" con junta	10	8435195827569	<b>4,39</b>

## FLORON UNIVERSAL



	Código	Medida	Caja	Código Barras	€ / Ud.
<b>Blanco</b>	<b>90260</b>	8 a 22 mm Ø	10	8435195833423	<b>0,27</b>
<b>Cromo</b>	<b>90261</b>	12 a 18 mm Ø	10	8435195833430	<b>0,96</b>

## TAPÓN RADIADOR ZINCADO Ø 42



	Código	Medida	Caja	Código Barras	€ / Ud.
<b>Izquierda</b>	<b>90269</b>	1" Ciego	10	8435195833492	<b>0,59</b>
	<b>90271</b>	1" x 1/8"	10	8435195833515	<b>0,59</b>
	<b>90273</b>	1" x 1/4"	10	8435195833539	<b>0,59</b>
	<b>90275</b>	1" x 3/8"	10	8435195833553	<b>0,59</b>
	<b>90277</b>	1" x 1/2"	10	8435195833577	<b>0,64</b>
<b>Derecha</b>	<b>90268</b>	1" ciego	10	8435195833485	<b>0,59</b>
	<b>90270</b>	1" x 1/8"	10	8435195833508	<b>0,59</b>
	<b>90272</b>	1" x 1/4"	10	8435195833522	<b>0,59</b>
	<b>90274</b>	1" x 3/8"	10	8435195833546	<b>0,59</b>
	<b>90276</b>	1" x 1/2"	10	8435195833560	<b>0,59</b>

## TAPÓN RADIADOR BLANCO Ø 42



	Código	Medida	Caja	Código Barras	€ / Ud.
<b>Izquierda</b>	<b>90279</b>	1" Ciego	10	8435195833591	<b>0,99</b>
	<b>90281</b>	1" x 1/8"	10	8435195833614	<b>0,99</b>
	<b>90259</b>	1" x 1/4"	10	8435195833638	<b>0,99</b>
	<b>90283</b>	1" x 3/8"	10	8435195833706	<b>0,99</b>
	<b>90285</b>	1" x 1/2"	10	8435195833669	<b>1,12</b>
<b>Derecha</b>	<b>90278</b>	1" ciego	10	8435195833584	<b>1,08</b>
	<b>90280</b>	1" x 1/8"	10	8435195833607	<b>0,99</b>
	<b>90258</b>	1" x 1/4"	10	8435195833621	<b>0,99</b>
	<b>90282</b>	1" x 3/8"	10	8435195833645	<b>0,99</b>
	<b>90284</b>	1" x 1/2"	10	8435195833652	<b>0,99</b>

## LLAVE UNIVAERSAL DE NYLON PARA TAPONES



Código	Medida	Caja	Código Barras	€ / Ud.
<b>90266</b>	1/2", 1" y 1 1/4"	1	8435195833447	<b>6,99</b>

## KIT UNIVERSAL TAPONES Ø 42



Código	Descripción	Caja	Código Barras	€ / Ud.
<b>90290</b>	Zincado	1	8435195833676	<b>7,52</b>
<b>90291</b>	Blanco	1	8435195833683	<b>8,23</b>

• Contiene: 2 Reduc. 1" x 1/2" derecha, 2 Reduc. 1" x 1/2" izquierda, 4 juntas, 1 tapón 1/2" y 1 purgador 1/2".

## SOPORTE RADIADOR REGULABLE

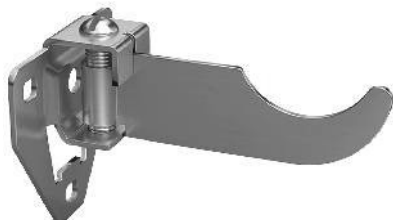

Código	Descripción	Caja	Código Barras	€ / Ud.
90301	Metal	10	8435195833454	1,56

## SOPORTE RADIADOR 1 PATILLA METÁLICO



Código	Descripción	Caja	Código Barras	€ / Ud.
90302	Metal	10	8435195833461	0,47

## SOPORTE RADIADOR 1 PATILLA NYLON



Código	Descripción	Caja	Código Barras	€ / Ud.
90306	Nylon	10	8435195833478	0,75

## CASQUILLO RADIADOR



Código	Medida	Caja	Código Barras	€ / Ud.
90296	1" x 30 mm	10	8435195833690	0,44



## JUNTAS Y ARANDELAS

<b>Juntas tóricas</b>		<b>220</b>
<b>Juntas planas</b>		<b>221</b>
<b>Arandelas de goma</b>		<b>222</b>
<b>Juntas de fibra</b>		<b>222</b>
<b>Juntas klinger</b>		<b>223</b>
<b>Juntas de teflón</b>		<b>223</b>



## JUNTAS Y ARANDELAS

### Juntas tóricas

#### ESTUCHE PARA JUNTAS



Código	Descripción	Caja	Código Barras	€ / Ud.
<b>99520</b>	Con separadores	1	8435195812732	<b>9,85</b>

#### JUNTAS TÓRICAS NBR-70 en pulgadas



	Código	Descripción	Medida	Caja	Código Barras	€ / Ud.
	<b>83020</b>	AN 00	2,20 x 1,60	50	8435195813975	<b>0,028</b>
	<b>83001</b>	AN 1	2,90 x 1,78	100	8435195813791	<b>0,025</b>
	<b>83002</b>	AN 2	3,68 x 1,78	100	8435195813807	<b>0,025</b>
	<b>83003</b>	AN 3	4,47 x 1,78	100	8435195813814	<b>0,025</b>
	<b>83004</b>	AN 4	5,28 x 1,78	100	8435195813821	<b>0,025</b>
<b>1/4"</b>	<b>83005</b>	AN 5	6,07 x 1,78	100	8435195813838	<b>0,025</b>
	<b>83006</b>	AN 6	7,65 x 1,78	100	8435195813845	<b>0,025</b>
	<b>83007</b>	AN 7	9,25 x 1,78	100	8435195813852	<b>0,025</b>
<b>3/8"</b>	<b>83008</b>	AN 8	9,19 x 2,62	100	8435195813869	<b>0,031</b>
	<b>83009</b>	AN 9	10,77 x 2,62	100	8435195813876	<b>0,031</b>
<b>1/2"</b>	<b>83010</b>	AN 10	12,37 x 2,62	100	8435195813883	<b>0,031</b>
	<b>83011</b>	AN 11	13,94 x 2,62	100	8435195813890	<b>0,041</b>
	<b>83012</b>	AN 12	15,54 x 2,62	100	8435195813906	<b>0,041</b>
<b>3/4"</b>	<b>83013</b>	AN 13	17,12 x 2,62	50	8435195813913	<b>0,041</b>
	<b>83014</b>	AN 14	18,64 x 2,62	50	8435195813920	<b>0,041</b>
	<b>83015</b>	AN 15	18,64 x 3,53	50	8435195813937	<b>0,052</b>
	<b>83016</b>	AN 16	20,22 x 3,53	50	8435195813944	<b>0,052</b>
	<b>83017</b>	AN 17	21,82 x 3,53	50	8435195813951	<b>0,063</b>
	<b>83018</b>	AN 18	23,39 x 3,53	50	8435195813968	<b>0,071</b>

#### ESTUCHE JUNTAS TÓRICAS NBR-70 en pulgadas



Código	Descripción	Caja	Código Barras	€ / Ud.
<b>83019</b>	18 medidas	650	8435195813982	<b>29,60</b>

• Contiene:

50 uds. de la Ref. 83001 a la 83007.

25 uds. de la Ref. 83008 a la 83018.

#### ESTUCHE JUNTAS TÓRICAS NBR-70 métrica



Código	Descripción	Caja	Código Barras	€ / Ud.
<b>83065</b>	19 medidas	650	8435195818116	<b>41,17</b>

• Contiene:

50 uds. de M 3 x 2 a M 10 x 2.

25 uds. de M 10 x 2,5 a M 25 x 3.



## JUNTAS Y ARANDELAS

### Juntas planas

#### JUNTAS PLANAS ANCHAS DE CAUCHO

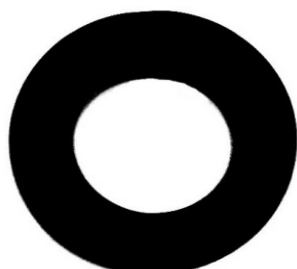

Código	Medida		Caja	Código Barras	€ / Ud.
<b>83502</b>	3/8"	8 x 14,5 x 2	100	8435195813999	<b>0,030</b>
<b>83503</b>	1/2"	10 x 18,5 x 2	100	8435195814002	<b>0,030</b>
<b>83520</b>	1/2"	10 x 18,5 x 4	100	8435195827767	<b>0,058</b>
<b>83504</b>	3/4"	12 x 23,5 x 2	100	8435195814019	<b>0,042</b>
<b>83509</b>	3/4"	13 x 23,5 x 3	100	8435195822687	<b>0,046</b>
<b>83505</b>	1"	20 x 30 x 2,5	100	8435195814026	<b>0,059</b>
<b>83506</b>	1 1/4"	29 x 37 x 2,5	100	8435195814033	<b>0,082</b>
<b>83507</b>	1 1/2"	30 x 44,5 x 2,5	100	8435195814040	<b>0,110</b>
<b>83508</b>	2"	46 x 56 x 2,5	100	8435195814057	<b>0,160</b>
<b>99322</b>	2 1/2"	57 x 69,5 x 3,5	10	8435195824667	<b>0,300</b>
<b>99334</b>	3"	70 x 82,5 x 3,5	10	8435195824674	<b>0,430</b>

#### JUNTAS PLANAS NORMALES DE CAUCHO

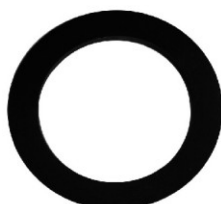

Código	Descripción		Caja	Código Barras	€ / Ud.
<b>84002</b>	3/8"	10 x 14,5 x 2	100	8435195814064	<b>0,035</b>
<b>84003</b>	1/2"	14 x 18,5 x 2	100	8435195814071	<b>0,038</b>
<b>84004</b>	3/4"	18 x 23,5 x 2	100	8435195814088	<b>0,043</b>
<b>84005</b>	1"	24 x 30 x 2,5	100	8435195814095	<b>0,056</b>
<b>84006</b>	1 1/4"	30 x 35 x 2,5	100	8435195814101	<b>0,076</b>
<b>84007</b>	1 1/2"	37 x 44,5 x 2,5	100	8435195814118	<b>0,098</b>
<b>84008</b>	2"	50 x 56 x 2,5	100	8435195814125	<b>0,150</b>

#### ESTUCHE JUNTAS PLANAS ANCHAS DE CAUCHO



Código	Descripción	Caja	Código Barras	€ / Ud.
<b>84009</b>	7 medidas	425	8435195814132	<b>28,07</b>

• Contiene: 100 uds. 3/8", 1/2" y 3/4" - 50 uds. 1" - 25 uds. 1 1/4", 1 1/2" y 2".

#### ESTUCHE JUNTAS PLANAS NORMALES DE CAUCHO



Código	Descripción	Caja	Código Barras	€ / Ud.
<b>84011</b>	7 medidas	425	8435195821390	<b>28,07</b>

• Contiene: 100 uds. 3/8", 1/2" y 3/4" - 50 uds. 1" - 25 uds. 1 1/4", 1 1/2" y 2".

#### ESTUCHE JUNTAS PLANAS MIXTAS DE CAUCHO



Código	Descripción	Caja	Código Barras	€ / Ud.
<b>84010</b>	7 medidas	425	8435195814149	<b>39,70</b>

• Contiene: ANCHAS: 100 uds. 3/8, 1/2" y 3/4" - 50 uds. 1"  
NORMALES: 100 uds. 3/8", 1/2" y 3/4" - 50 uds. 1"

#### JUNTAS CON FILTRO INOXIDABLE



Código	Medida	Caja	Código Barras	€ / Ud.
<b>83515</b>	1/2"	25	8435195827774	<b>0,49</b>
<b>83516</b>	3/4"	25	8435195827781	<b>0,54</b>



## JUNTAS Y ARANDELAS

Arandelas de goma y juntas de fibra

### ARANDELAS DE GOMA BLANCA CÓNICAS



Código	Medida	Caja	Código Barras	€ / Ud.
<b>84012</b>	3/8" x 50	100	8435195814156	<b>0,370</b>
<b>84013</b>	1/2" x 51	100	8435195814163	<b>0,380</b>
<b>84014</b>	3/4" x 57	100	8435195814170	<b>0,420</b>
<b>84015</b>	1" x 61	100	8435195814187	<b>0,440</b>
<b>84016</b>	1 1/4" x 61	100	8435195814194	<b>0,450</b>
<b>84017</b>	1 1/2" x 66	50	8435195814200	<b>0,840</b>
<b>84018</b>	2" x 83	50	8435195814958	<b>0,670</b>

### ARANDELAS DE GOMA BLANCA SEMICÓNICAS

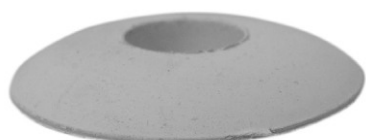

Código	Medida	Caja	Código Barras	€ / Ud.
<b>84022</b>	3/8" x 50	100	8435195814217	<b>0,660</b>
<b>84023</b>	1/2" x 51	100	8435195814224	<b>0,370</b>
<b>84024</b>	3/4" x 57	100	8435195814231	<b>0,430</b>
<b>84025</b>	1" x 61	100	8435195814248	<b>0,430</b>
<b>84026</b>	1 1/4" x 61	100	8435195814255	<b>0,440</b>
<b>84027</b>	1 1/2" x 66	50	8435195814262	<b>0,770</b>
<b>84028</b>	2" x 83	50	8435195820256	<b>0,860</b>

### ARANDELAS DE GOMA BLANCA PLANAS



Código	Medida		Caja	Código Barras	€ / Ud.
<b>84032</b>	3/8"	16 x 32 x 2	100	8435195814279	<b>0,075</b>
<b>84033</b>	1/2"	20 x 45 x 2	100	8435195814286	<b>0,099</b>
<b>84034</b>	3/4"	25 x 60 x 2	100	8435195814293	<b>0,140</b>
<b>84035</b>	1"	35 x 70 x 2	100	8435195814309	<b>0,190</b>
<b>84036</b>	1 1/4"	40 x 70 x 2	100	8435195814316	<b>0,190</b>
<b>84037</b>	1 1/2"	45 x 70 x 2	100	8435195814323	<b>0,190</b>
<b>84038</b>	2"	50 x 80 x 2	100	8435195814330	<b>0,200</b>

### JUNTAS PLANAS DE FIBRA



Código	Medida	Caja	Código Barras	€ / Ud.
<b>84501</b>	16 x 1,5	100	8435195814347	<b>0,100</b>
<b>84502</b>	17 x 1,5	100	8435195814354	<b>0,100</b>
<b>84503</b>	18 x 1,5	100	8435195814361	<b>0,100</b>
<b>84504</b>	19 x 1,5	100	8435195814378	<b>0,100</b>
<b>84505</b>	20 x 1,5	100	8435195814385	<b>0,100</b>
<b>84506</b>	21 x 1,5	100	8435195814392	<b>0,100</b>
<b>84507</b>	22 x 1,5	100	8435195814408	<b>0,100</b>

### ESTUCHE JUNTAS PLANAS DE FIBRA



Código	Descripción	Caja	Código Barras	€ / Ud.
<b>84508</b>	7 medidas	700	8435195814415	<b>69,70</b>

• Contiene: 100 uds. por medida.





## JUNTAS Y ARANDELAS

Juntas klinger y juntas de teflón

### JUNTAS PLANAS KLINGER SIN AMIANTO



Código	Medida		Caja	Código Barras	€ / Ud.
<b>84515</b>	1/8"	racor	100	8435195814422	<b>0,070</b>
<b>84516</b>	1/4"	racor	100	8435195814439	<b>0,070</b>
<b>84517</b>	3/8"	racor	100	8435195814446	<b>0,070</b>
<b>84518</b>	1/2" x 10	flexo	100	8435195814453	<b>0,084</b>
<b>84519</b>	1/2" x 12	racor	100	8435195820263	<b>0,084</b>
<b>84520</b>	1/2" x 14	racor	100	8435195814460	<b>0,084</b>
<b>84521</b>	3/4" x 13	batería	100	8435195814477	<b>0,092</b>
<b>84522</b>	3/4" x 17	batería	100	8435195814484	<b>0,092</b>
<b>84523</b>	3/4" x 18	racor	100	8435195814491	<b>0,092</b>
<b>84524</b>	1"	racor	100	8435195814507	<b>0,120</b>
<b>84525</b>	1"	ancha	100	8435195814514	<b>0,120</b>
<b>84528</b>	1"	radiador	100	8435195814521	<b>0,130</b>
<b>84514</b>	1 1/4"	racor	100	8435195814538	<b>0,180</b>
<b>84526</b>	1 1/4"	ancha	100	8435195814545	<b>0,180</b>
<b>84527</b>	1 1/2"	ancha	100	8435195814552	<b>0,200</b>
<b>84532</b>	2"	racor	25	8435195833713	<b>0,320</b>
<b>84555</b>	2"	ancha	25	8435195833720	<b>0,490</b>

### ESTUCHE JUNTAS PLANAS KLINGER SIN AMIANTO



Código	Descripción	Caja	Código Barras	€ / Ud.
<b>84529</b>	14 medidas	950	8435195814569	<b>69,75</b>

1/8" (100)	1/2" x 10 (100)	3/4" x 13 (50)	1" racor (50)	1 1/4" (25)
1/4" (100)	1/2" x 12 (100)	3/4" x 17 (50)	1" ancha (50)	1 1/2" (25)
3/8" (100)	1/2" x 14 (100)	3/4" x 18 (50)	1" radiador (25)	

### JUNTAS PLANAS DE TEFLÓN



Código	Medida		Caja	Código Barras	€ / Ud.
<b>84535</b>	3/8"	14'5 x 7 x 1'5	100	8435195814576	<b>0,074</b>
<b>84536</b>	3/8"	14'5 x 10 x 1'5	100	8435195814583	<b>0,074</b>
<b>84537</b>	1/2" x 10	18'5 x 10 x 1'5	100	8435195814590	<b>0,120</b>
<b>84538</b>	1/2" x 12	18'5 x 12 x 1'5	100	8435195814606	<b>0,140</b>
<b>84539</b>	1/2" x 14	18'5 x 14 x 1'5	100	8435195814613	<b>0,120</b>
<b>84540</b>	3/4" x 13	24 x 13 x 1'5	100	8435195814620	<b>0,130</b>
<b>84541</b>	3/4" x 18	24 x 18 x 1'5	100	8435195814637	<b>0,130</b>
<b>84542</b>	3/4" x 19	24 x 19 x 1'5	100	8435195814644	<b>0,130</b>
<b>84533</b>	7/8"	27 x 21 x 1'5	100	8435195814651	<b>0,130</b>
<b>84543</b>	1"	30 x 24 x 1'5	100	8435195814668	<b>0,140</b>
<b>84544</b>	1 1/4"	39 x 30 x 1'5	100	8435195814675	<b>0,260</b>
<b>84545</b>	1 1/2"	45 x 37 x 1'5	100	8435195814682	<b>0,240</b>
<b>84546</b>	1"	42 x 33 x 1'5	100	8435195814699	<b>0,190</b>
<b>84547</b>	1 1/4"	50 x 41 x 1'5	100	8435195814705	<b>0,230</b>
<b>84549</b>	1"	30 x 20 x 1'5	100	8435195814712	<b>0,160</b>
<b>84550</b>	2"	57 x 49 x 1'5	100	8435195820270	<b>0,470</b>

### ESTUCHE JUNTAS PLANAS DE TEFLÓN



Código	Descripción	Caja	Código Barras	€ / Ud.
<b>84548</b>	13 medidas	825	8435195812190	<b>94,70</b>

3/8" x 7 (100)	1/2" x 14 (100)	1" x 24 (50)
3/8" x 10 (100)	3/4" x 13 (50)	1" x 33 (50)
1/2" x 10 (100)	3/4" x 18 (50)	1 1/4" x 30 ( 25)
1/2" x 12 (100)	3/4" x 19 (50)	1 1/4 x 41 ( 25)
		1 1/2" x 37 (25)





## MEMBRANAS

**Membranas**



**226**

# MEMBRANAS



## MEMBRANAS PARA CALENTADOR



Marca	Código	Nº	Descripción	Caja	Código Barras	€ / Ud.
<b>Cointra Agni Corcho</b>	<b>88041</b>	2	5 l. antiguo	25	8435195815658	<b>0,96</b>
	<b>88042</b>	3	10 l. moderno	25	8435195815665	<b>0,96</b>
	<b>88043</b>	19	10 l. antiguo	25	8435195815672	<b>0,96</b>
	<b>88044</b>	0	5 l. Cointra	25	8435195815689	<b>1,25</b>



<b>Fagor Aspes</b>	<b>88045</b>	4	5 l. David	25	8435195815696	<b>0,96</b>
	<b>88046</b>	5	5 l. 5 K moderno	25	8435195844900	<b>0,96</b>
	<b>88047</b>	6	5l. 10 TE antiguo	25	8435195815719	<b>0,96</b>
	<b>88048</b>	7	5l. 10TE 10K moderno	25	8435195815726	<b>0,96</b>
	<b>88049</b>	8	10 l. Bules moderno	25	8435195815733	<b>0,96</b>
<b>88050</b>	33	5l. D15 D50 moderno	25	8435195815740	<b>1,25</b>	



<b>Otsein</b>	<b>88051</b>	9	5 l. y 10 l. antiguo baja presión	25	8435195815757	<b>0,75</b>
	<b>88052</b>	10	5 l. y 10 l. moderno	25	8435195815764	<b>0,75</b>
	<b>88053</b>	11	5 l. y 10 l. moderno	25	8435195815771	<b>0,96</b>



<b>Balay Aitona Fuima</b>	<b>88054</b>	12	5 l. 7 l. 10 l. moderno	25	8435195815788	<b>0,96</b>
	<b>88055</b>	37	Alta y baja presión	25	8435195815795	<b>0,96</b>
	<b>88056</b>	38	Alta y baja presión	25	8435195815801	<b>0,96</b>



<b>Junkers</b>	<b>88057</b>	13	5 l. moderno FD-330	25	8435195815818	<b>1,45</b>
	<b>88059</b>	25	5 l. antiguo	25	8435195815832	<b>0,96</b>
	<b>88060</b>	26	10 l. antiguo	25	8435195815849	<b>0,96</b>

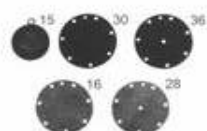

<b>Corberó</b>	<b>88061</b>	15	5 l. moderno C-51 y C-52	25	8435195815856	<b>0,96</b>
	<b>88062</b>	30	5 l. antiguo LM-8 baja presión	25	8435195815863	<b>1,05</b>
	<b>88063</b>	36	10 l. moderno LM25/LM-26	25	8435195815870	<b>1,05</b>
	<b>88064</b>	16	5 l. LM-8 presión normal	25	8435195815887	<b>1,05</b>
	<b>88065</b>	28	10 l. LM25/LM26 presión normal	25	8435195815894	<b>1,05</b>



<b>Orbegozo</b>	<b>88066</b>	17	10 l. moderno	25	8435195815900	<b>0,96</b>
	<b>88067</b>	18	5 l. antiguo	25	8435195815917	<b>0,96</b>



<b>Vaillant</b>	<b>88068</b>	22	10 l. moderno	25	8435195815900	<b>0,96</b>
	<b>88069</b>	20	5 l. antiguo	25	8435195815917	<b>0,96</b>



<b>Saunier Duval</b>	<b>88070</b>	21	5 l. moderno	25	8435195815948	<b>0,96</b>
	<b>88071</b>	23	10 l. moderno	25	8435195815955	<b>0,96</b>



<b>Chafoteaux Roca</b>	<b>88072</b>	27	5 l. y 10 l. moderno	25	8435195815818	<b>0,96</b>
	<b>88073</b>	34	Roca - Chafoteaux	25	8435195815825	<b>0,96</b>
	<b>88074</b>	35	Chafoteaux	25	8435195815832	<b>0,96</b>
	<b>88075</b>	24	Tropik	25	8435195815849	<b>1,05</b>



## SOLETAS Y PORTASOLETAS

Soletas y portasoletas



228

## SOLETAS Y PORTASOLETAS



### PORTASOLETAS DE ACERO INOXIDABLE



Código	Medida	Caja	Código Barras	€ / Ud.
<b>87001</b>	16/150	100	8435195815283	<b>0,12</b>
<b>87002</b>	17/150	100	8435195815290	<b>0,12</b>
<b>87003</b>	18/150	100	8435195815306	<b>0,12</b>
<b>87004</b>	19/150	100	8435195815313	<b>0,12</b>

### PORTASOLETAS DE LATÓN



Código	Medida	Caja	Código Barras	€ / Ud.
<b>99166</b>	3/4"	100	8435195815320	<b>0,49</b>

• Sirve para la soleta de 20 x 4 x 4 - Cód. 88008.

### SOLETAS DE CAUCHO

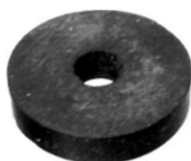

	Código	Medida	Caja	Código Barras	€ / Ud.
<b>Nº 8</b>	<b>88001</b>	12 x 4 x 4	100	8435195815351	<b>0,037</b>
	<b>88002</b>	13 x 4 x 4	100	8435195815368	<b>0,037</b>
<b>Nº 11</b>	<b>88003</b>	14 x 4 x 4	100	8435195815375	<b>0,037</b>
	<b>88004</b>	15 x 4 x 4	100	8435195815382	<b>0,037</b>
<b>Nº 13</b>	<b>88005</b>	16 x 4 x 4	100	8435195815399	<b>0,038</b>
	<b>88006</b>	17 x 4 x 4	100	8435195815405	<b>0,038</b>
<b>Nº 16</b>	<b>88007</b>	18 x 4 x 4	100	8435195815412	<b>0,040</b>
<b>Nº 20</b>	<b>88008</b>	20 x 4 x 4	100	8435195815429	<b>0,042</b>
	<b>88026</b>	24 x 4 x 4	100	8435195828122	<b>0,130</b>

### SOLETAS DE CAUCHO CIEGAS



	Código	Medida	Caja	Código Barras	€ / Ud.
<b>Nº 8</b>	<b>88010</b>	12 x 4 x 4	100	8435195815443	<b>0,037</b>
	<b>88011</b>	13 x 4 x 4	100	8435195815450	<b>0,037</b>
<b>Nº 11</b>	<b>88012</b>	14 x 4 x 4	100	8435195815467	<b>0,037</b>
	<b>88013</b>	15 x 4 x 4	100	8435195815474	<b>0,037</b>
<b>Nº 13</b>	<b>88014</b>	16 x 4 x 4	100	8435195815481	<b>0,038</b>
	<b>88015</b>	17 x 4 x 4	100	8435195815498	<b>0,038</b>
<b>Nº 16</b>	<b>88016</b>	18 x 4 x 4	100	8435195815504	<b>0,040</b>
<b>Nº 20</b>	<b>88017</b>	20 x 4 x 4	100	8435195815511	<b>0,041</b>
	<b>88018</b>	27 x 5 x 4	100	8435195844870	<b>0,200</b>

### ESTUCHE DE SOLETAS DE CAUCHO



Código	Descripción	Caja	Código Barras	€ / Ud.
<b>88009</b>	16 medidas	800	8435195815436	<b>36,79</b>

• Contiene:

50 uds. de la Ref. 88001 a la 88008.

50 uds. de la Ref. 88010 a la 88017.



## ACCESORIOS DE SELLADO

<b>Rollo de teflón</b>		<b>230</b>
<b>Hilo sellador</b>		<b>230</b>
<b>Cáñamo</b>		<b>230</b>
<b>Pasta tipo Unibond</b>		<b>230</b>
<b>Lana de acero</b>		<b>230</b>
<b>Cinta adhesiva</b>		<b>231</b>
<b>Carrete estaño plata y cobre</b>		<b>231</b>
<b>Gel decapante</b>		<b>231</b>



## ACCESORIOS DE SELLADO

### ROLLO DE TEFLÓN



	Código	Medida	Caja	Código Barras	€ / Ud.
	<b>73001</b>	12 m. x 12 mm. x 0,075 mm.	250	8435195812169	<b>0,31</b>
<b>Gas</b>	<b>73003</b>	12 m. x 12 mm. x 0,10 mm.	250	8435195812176	<b>0,39</b>
<b>Polietileno</b>	<b>73004</b>	50 m. x 19 mm. x 0,10 mm.	63	8435195812183	<b>2,90</b>

### HILO SELLADOR DE TUBERÍAS



Código	Medida	Caja	Código Barras	€ / Ud.
<b>73005</b>	150 m.	10	8435195815634	<b>21,80</b>

Código	Medida	Caja	Código Barras	€ / Ud.
<b>73006</b>	50 m.	10	8435195815702	<b>9,95</b>

### MADEJA DE CÁÑAMO



Código	Medida	Caja	Código Barras	€ / Ud.
<b>73007</b>	-	1	8435195822694	<b>2,98</b>

### PASTA TIPO UNIBOND PARA ROSCAR CON CÁÑAMO



Código	Medida	Caja	Código Barras	€ / Ud.
<b>73008</b>	-	1	8435195822700	<b>8,30</b>

### BOLSA DE LANA ACERO



Código	Medida	Caja	Código Barras	€ / Ud.
<b>73009</b>	63 grs.	1	8435195824995	<b>2,34</b>





## ACCESORIOS DE SELLADO

### CINTA ADHESIVA



Código	Medida	Caja	Código Barras	€ / Ud.
<b>73015</b>	50 m. x 50 mm.	10	8435195827798	<b>6,95</b>
<b>73016</b>	10 m. x 50 mm.	10	8435195827804	<b>2,98</b>
<b>73017</b>	25 m. x 50 mm.	10	8435195827811	<b>6,56</b>

### CARRETE ESTAÑO PLATA TIPO MAR-PLUS



Código	Descripción	Caja	Código Barras	€ / Ud.
<b>49096</b>	3,5% - 250 gr.	10	8435195806526	<b>13,12</b>
<b>49097</b>	6% - 250 gr.	10	8435195806533	<b>13,90</b>

### CARRETE ESTAÑO COBRE PARA SOLDAR GAS TIPO MAR-PLUS



Código	Descripción	Caja	Código Barras	€ / Ud.
<b>49095</b>	6% - 250 gr.	10	8435195838619	<b>18,70</b>

### GEL DECAPANTE FLUX



Código	Descripción	Caja	Código Barras	€ / Ud.
<b>49098</b>	100 gr.	10	8435195806540	<b>3,60</b>





## ACCESORIOS PARA GAS

**Reguladores de butano**



**234**

**Goma de butano**



**234**

**Gas hermeto y soldar**



**235**

**Soportes y tapas de contador**



**239**

## REGULADOR BOTELLA DE BUTANO



Código	Descripción	Caja	Código Barras	€ / Ud.
<b>73030</b>	Doméstico	1	8435195827828	<b>15,48</b>

- Regulador para botella doméstica.
- Presión salida regulada 30 mbar.
- Caudal 2,5 kg/h.
- Salida a manguera 9 mm. Ø interior.
- Standard K-30.



Código	Descripción	Caja	Código Barras	€ / Ud.
<b>73032</b>	Con corte	1	8435195827842	<b>18,60</b>

- Regulador para botella doméstica.
- Presión salida regulada 30 mbar.
- Caudal 2,5 kg/h.
- Salida a manguera 9 mm. Ø interior.
- Con corte por exceso de flujo.



Código	Descripción	Caja	Código Barras	€ / Ud.
<b>73031</b>	Salida libre	1	8435195827835	<b>19,47</b>

- Presión salida regulada hasta 1,7 bar.
- Mando negro.
- Sistema acople rápido.
- Salida rosca izquierda 21,8.

## MANGUERA PARA GAS BUTANO



Código	Descripción	Caja	Código Barras	€ / Ud.
<b>73036</b>	60 m.	1	8435195827859	<b>63,82</b>



Código	Descripción	Caja	Código Barras	€ / Ud.
<b>73037</b>	1,5 m. con 2 abrazaderas	1	8435195827866	<b>3,91</b>



## ACCESORIOS PARA GAS

Gas hermeto

### UNIÓN HERMETO CROMO



Código	Medida	Caja	Código Barras	€ / Ud.
<b>89002</b>	10 x 10	25	8435195816006	<b>2,99</b>
<b>89003</b>	12 x 12	25	8435195816013	<b>3,38</b>

	Código	Medida	Caja	Código Barras	€ / Ud.
<b>Reducida</b>	<b>89006</b>	10 x 12	25	8435195816037	<b>3,65</b>

### REDUCCIÓN HERMETO CROMO

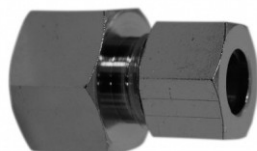

Código	Medida	Caja	Código Barras	€ / Ud.
<b>89007</b>	1/2" x 10	25	8435195816044	<b>2,83</b>
<b>89008</b>	1/2" x 12	25	8435195816051	<b>2,90</b>
<b>89009</b>	3/4" x 10	25	8435195816068	<b>3,77</b>
<b>89010</b>	3/4" x 12	25	8435195816075	<b>3,87</b>

### BOQUILLA HERMETO CROMO



Código	Medida	Caja	Código Barras	€ / Ud.
<b>89012</b>	10 Ø	25	8435195816082	<b>2,08</b>
<b>89013</b>	12 Ø	25	8435195816099	<b>2,44</b>

### CODO HERMETO CROMO



Código	Medida	Caja	Código Barras	€ / Ud.
<b>89017</b>	10 x 10	25	8435195816198	<b>4,24</b>
<b>89018</b>	12 x 12	25	8435195816204	<b>4,86</b>

### TE HERMETO CROMO



Código	Medida	Caja	Código Barras	€ / Ud.
<b>89021</b>	10 x 10 x 10	25	8435195816211	<b>5,59</b>
<b>89022</b>	12 x 12 x 12	25	8435195816228	<b>6,53</b>



## ACCESORIOS PARA GAS

Gas soldar

### UNIÓN SOLDAR S/COLOR

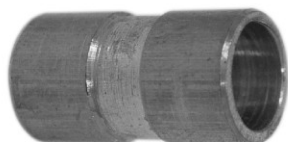

Código	Medida	Caja	Código Barras	€ / Ud.
<b>89046</b>	10 x 10	50	8435195816389	<b>0,85</b>
<b>89047</b>	12 x 12	50	8435195816396	<b>0,89</b>

<b>Reducida</b>	<b>89048</b>	10 x 12	50	8435195816402	<b>0,94</b>
-----------------	--------------	---------	----	---------------	-------------

### BOQUILLA LISA SOLDAR S/COLOR



Código	Medida	Caja	Código Barras	€ / Ud.
<b>89015</b>	10 Ø	50	8435195816105	<b>0,70</b>
<b>89016</b>	12 Ø	50	8435195816112	<b>0,84</b>

### BOQUILLA SOLDAR S/COLOR



Código	Medida	Caja	Código Barras	€ / Ud.
<b>89050</b>	10 Ø	50	8435195816129	<b>0,78</b>
<b>89051</b>	12 Ø	50	8435195816136	<b>0,83</b>

### BOQUILLA SOLDAR CANARIAS S/COLOR



Código	Medida	Caja	Código Barras	€ / Ud.
<b>89052</b>	10 Ø	50	8435195816143	<b>0,23</b>

### CODO SOLDAR S/COLOR



Código	Medida	Caja	Código Barras	€ / Ud.
<b>89071</b>	10 x 10	25	8435195816150	<b>2,28</b>
<b>89073</b>	12 x 12	25	8435195816167	<b>2,58</b>

### TE SOLDAR S/COLOR



Código	Medida	Caja	Código Barras	€ / Ud.
<b>89072</b>	10 x 10 x 10	25	8435195816174	<b>2,53</b>
<b>89074</b>	12 x 12 x 12	25	8435195816181	<b>3,14</b>

## ACCESORIOS PARA GAS



### TUERCA HERMETO CROMO



Código	Medida	Caja	Código Barras	€ / Ud.
<b>89024</b>	10 Ø	100	8435195816235	<b>0,76</b>
<b>89025</b>	12 Ø	100	8435195816242	<b>0,80</b>

### BICONO HERMETO LATÓN

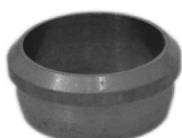

Código	Medida	Caja	Código Barras	€ / Ud.
<b>89027</b>	10 Ø	100	8435195816280	<b>0,28</b>
<b>89028</b>	12 Ø	100	8435195816297	<b>0,34</b>

### TUERCA VÁLVULA GAS SOLDAR CROMO



Código	Medida	Caja	Código Barras	€ / Ud.
<b>89026</b>	10 Ø	25	8435195816259	<b>0,70</b>

### MANGUITO VÁLVULA GAS SOLDAR LATÓN



Código	Medida	Caja	Código Barras	€ / Ud.
<b>89044</b>	10 Ø	25	8435195816266	<b>0,62</b>

Código	Descripción	Caja	Código Barras	€ / Ud.
<b>89043</b>	Junta manguito	25	8435195816273	<b>0,10</b>

### MANGUITO SOLDAR S/COLOR



Código	Medida	Caja	Código Barras	€ / Ud.
<b>89038</b>	20/150 x 10 Ø	100	8435195816341	<b>0,66</b>
<b>89039</b>	20/150 x 12 Ø	100	8435195816358	<b>0,72</b>
<b>89040</b>	1/2" x 14 Ø	100	8435195816365	<b>0,72</b>
<b>89041</b>	1/2" x 15 Ø	100	8435195816372	<b>0,75</b>

Código	Descripción	Caja	Código Barras	€ / Ud.
<b>89042</b>	Junta manguito	100	8435195815337	<b>0,10</b>

### TUERCA CONEXIÓN GAS JUNTA PLANA CROMO

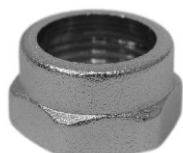

Código	Medida	Caja	Código Barras	€ / Ud.
<b>89033</b>	20/150 x 15 Ø	100	8435195816303	<b>1,24</b>
<b>89034</b>	21,8 izq. X 15 Ø	100	8435195816310	<b>1,46</b>
<b>89035</b>	1/2" x 15 Ø	100	8435195816327	<b>1,19</b>
<b>89036</b>	1/2" x 17 Ø	100	8435195816334	<b>1,09</b>

### CONJUNTO TUERCA Y BICONO COMPRESIÓN



Código	Medida	Caja	Código Barras	€ / Ud.
<b>99361</b>	3/8" x 10 Ø	50	8435195812237	<b>1,91</b>
<b>99364</b>	1/2" x 10 Ø	50	8435195812244	<b>2,88</b>

## ACCESORIOS PARA GAS



### VÁLVULA HERMETO GAS BUTANO



Código	Medida	Caja	Código Barras	€ / Ud.
<b>89056</b>	10 x 10	120	8435195816556	<b>10,74</b>
<b>89057</b>	12 x 12	120	8435195816563	<b>12,39</b>

### VÁLVULA SOLDAR GAS BUTANO



Código	Medida	Caja	Código Barras	€ / Ud.
<b>89053</b>	10 x 10	120	8435195816532	<b>11,89</b>
<b>89054</b>	12 x 12	120	8435195816549	<b>13,13</b>

### VÁLVULA PROPANO NATURAL



Código	Medida	Caja	Código Barras	€ / Ud.
<b>89062</b>	20/150 x 20/150	120	8435195816570	<b>9,83</b>
<b>89063</b>	21,8 izq. X 21,8 izq.	120	8435195816587	<b>9,99</b>
<b>89064</b>	1/2" x 1/2"	120	8435195816594	<b>10,15</b>
<b>89066A</b>	3/4" x 3/4"	60	8435195816600	<b>15,20</b>

- Conexión junta plana.

### DERIVACIÓN BOQUILLA HERMETO CROMO



Código	Medida	Caja	Código Barras	€ / Ud.
<b>89070</b>	10 Ø	25	8435195816426	<b>4,98</b>

### DERIVACIÓN BOQUILLA 3 SALIDAS S/COLOR



Código	Medida	Caja	Código Barras	€ / Ud.
<b>89069</b>	10 Ø	25	8435195816419	<b>3,40</b>

### ABRAZADERA TUBO



Código	Medida	Caja	Código Barras	€ / Ud.
<b>89066</b>	10 Ø	500	8435195816433	<b>0,69</b>
<b>89067</b>	12 Ø	500	8435195816440	<b>0,69</b>

- Incluye taco y tornillo.

### ABRAZADERA GOMA



Código	Medida	Caja	Código Barras	€ / Ud.
<b>89068</b>	14 x 16	100	8435195816457	<b>0,39</b>
<b>89069A</b>	16 x 18	100	8435195816464	<b>0,49</b>



## ACCESORIOS PARA GAS



### SOPORTE CONTADOR GAS FRONTAL



Código	Medida	Caja	Código Barras	€ / Ud.
<b>89095</b>	21,5 x 11,5 x 6 cm.	50	8435195816471	<b>2,75</b>

- Blanco.

### SOPORTE CONTADOR GAS LATERAL



Código	Medida	Caja	Código Barras	€ / Ud.
<b>89096</b>	27 x 12 x 6 cm.	40	8435195816488	<b>3,14</b>

- Blanco.

### TAPA PARA CONTADOR DE GAS

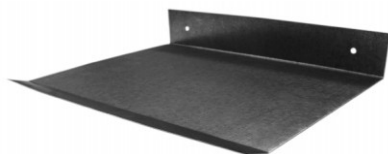

Código	Descripción	Caja	Código Barras	€ / Ud.
<b>890101</b>	Frontal	50	8435195816495	<b>2,97</b>
<b>890102</b>	Lateral	40	8435195816501	<b>3,29</b>
<b>890103</b>	Especial	40	8435195816518	<b>2,97</b>
<b>890104</b>	Separadora	30	8435195816525	<b>4,54</b>

- Chapa galvanizada.





## ACCESORIOS DE VENTILACIÓN

**Rejillas**



**242**

**Difusores**



**244**

# ACCESORIOS VENTILACIÓN

Rejillas metálicas



## REJILLA EMPOTRAR



	Código	Descripción	Caja	Código Barras	€ / Ud.
<b>17 x 17</b>	<b>60001</b>	Blanco	100	8435195808940	<b>1,68</b>
	<b>60002</b>	Aluminio	100	8435195808957	<b>1,50</b>
	<b>60003</b>	Color madera	100	8435195808964	<b>1,80</b>
	<b>60004</b>	Aluminio blanco	100	8435195808971	<b>1,82</b>



	Código	Descripción	Caja	Código Barras	€ / Ud.
<b>20 x 20</b>	<b>60005</b>	Blanco	80	8435195808988	<b>2,08</b>
	<b>60006</b>	Aluminio	80	8435195808995	<b>1,98</b>
	<b>60007</b>	Aluminio blanco	80	8435195809008	<b>2,72</b>

## REJILLA PLANA



	Código	Descripción	Caja	Código Barras	€ / Ud.
<b>10 x 10</b>	<b>60011</b>	Blanco	100	8435195809015	<b>0,75</b>
	<b>60012</b>	Aluminio	100	8435195809022	<b>0,66</b>
	<b>60014</b>	Color madera	100	8435195809046	<b>0,89</b>
	<b>60013</b>	Aluminio blanco	100	8435195809046	<b>0,84</b>

<b>15 x 15</b>	<b>60501</b>	Blanco	100	8435195809091	<b>0,99</b>
	<b>60502</b>	Aluminio	100	8435195809107	<b>0,83</b>
	<b>60503</b>	Color madera	100	8435195809114	<b>1,08</b>
	<b>60504</b>	Aluminio blanco	100	8435195809121	<b>1,05</b>

<b>17 x 17</b>	<b>60506</b>	Blanco	100	8435195809138	<b>1,21</b>
	<b>60507</b>	Aluminio	100	8435195809145	<b>1,05</b>
	<b>60508</b>	Color madera	100	8435195809152	<b>1,47</b>
	<b>60509</b>	Aluminio blanco	100	8435195809169	<b>1,37</b>

<b>20 x 20</b>	<b>60511</b>	Blanco	100	8435195809176	<b>1,43</b>
	<b>60512</b>	Aluminio	100	8435195809183	<b>1,25</b>
	<b>60514</b>	Color madera	100	8435195809206	<b>1,63</b>
	<b>60513</b>	Aluminio blanco	100	8435195809190	<b>1,46</b>

## REJILLA PLANA



<b>20 x 10</b>	<b>60016</b>	Blanco	100	8435195809053	<b>0,99</b>
	<b>60017</b>	Aluminio	100	8435195809060	<b>0,93</b>
	<b>60019</b>	Color madera	100	8435195809084	<b>1,05</b>
	<b>60018</b>	Aluminio blanco	100	8435195809077	<b>1,03</b>



<b>15 X 30</b>	<b>60515</b>	Blanco	100	8435195809213	<b>1,68</b>
	<b>60516</b>	Aluminio	100	8435195809220	<b>1,37</b>
	<b>60517</b>	Color madera	100	8435195809237	<b>2,04</b>
	<b>60505</b>	Aluminio blanco	100	8435195809244	<b>1,74</b>

# ACCESORIOS VENTILACIÓN

Rejillas ABS



## REJILLA EMPOTRAR CUADRADA



	Código	Descripción	Caja	Código Barras	€ / Ud.
<b>15 x 15</b> <b>Sin cierre</b>	<b>60528</b>	Blanco	50	8435195809312	<b>1,75</b>
<b>17 x 17</b> <b>Sin cierre</b>	<b>60518</b>	Blanco	50	8435195809251	<b>1,43</b>
	<b>60519</b>	Color madera	50	8435195809268	<b>1,43</b>



	Código	Descripción	Caja	Código Barras	€ / Ud.
<b>17 x 17</b> <b>Con cierre</b>	<b>60533</b>	Blanco	50	8435195841282	<b>2,38</b>
<b>20 x 20</b> <b>Con cierre</b>	<b>60534</b>	Blanco	50	8435195841299	<b>3,26</b>

## MARCO REJILLA CUADRADA



	Código	Descripción	Caja	Código Barras	€ / Ud.
<b>15 x 15</b>	<b>60529</b>	Blanco	50	8435195809367	<b>0,84</b>
<b>17 x 17</b>	<b>60522</b>	Blanco	50	8435195809329	<b>0,62</b>

## REJILLA EMPOTRAR RECTANGULAR



	Código	Descripción	Caja	Código Barras	€ / Ud.
<b>22 x 9,5</b> <b>Sin cierre</b>	<b>60520</b>	Blanco	100	8435195809275	<b>1,70</b>
	<b>60521</b>	Color madera	100	8435195809282	<b>1,68</b>
<b>22 x 9,5</b> <b>Con cierre</b>	<b>60536</b>	Blanco	50	8435195841312	<b>2,39</b>

## MARCO REJILLA RECTANGULAR



	Código	Descripción	Caja	Código Barras	€ / Ud.
<b>22 x 9,5</b>	<b>60524</b>	Blanco	50	8435195809343	<b>0,62</b>
	<b>60525</b>	Color madera	50	8435195809350	<b>0,62</b>

## REJILLA EMPOTRAR REDONDA



	Código	Descripción	Caja	Código Barras	€ / Ud.
<b>15 cm. Ø</b>	<b>60526</b>	Blanco	100	8435195809299	<b>1,67</b>
	<b>60527</b>	Color madera	100	8435195809305	<b>1,67</b>

## MARCO REJILLA REDONDA



	Código	Descripción	Caja	Código Barras	€ / Ud.
<b>15 cm. Ø</b>	<b>60530</b>	Blanco	50	8435195809374	<b>1,15</b>



## ACCESORIOS VENTILACIÓN

Rejillas ABS y difusores

### REJILLA Y MARCO

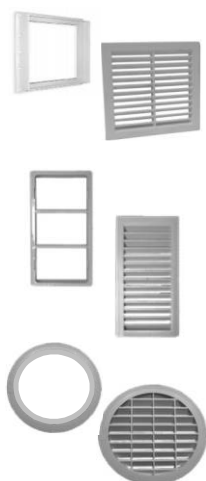

	Código	Descripción	Caja	Código Barras	€ / Ud.
<b>17 x 17</b> <b>Sin cierre</b>	<b>60537</b>	Blanco	50	8435195841329	<b>2,27</b>
	<b>60539</b>	Blanco	50	8435195841336	<b>3,35</b>
<b>20 x 20</b> <b>Sin cierre</b>	<b>60540</b>	Blanco	50	8435195841343	<b>2,32</b>
	<b>60541</b>	Blanco	50	8435195841350	<b>2,82</b>

### MOSQUITERA REJILLA

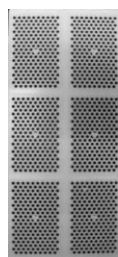

	Código	Descripción	Caja	Código Barras	€ / Ud.
<b>22 x 9,5</b>	<b>60532</b>	Blanco	50	8435195833751	<b>0,64</b>

### DIFUSOR 2 DISCOS HIERRO BLANCO



	Código	Medida	Caja	Código Barras	€ / Ud.
	<b>61001</b>	100 Ø	64	8435195809398	<b>3,25</b>
	<b>61002</b>	110 Ø	64	8435195809404	<b>3,25</b>
	<b>61003</b>	120 Ø	64	8435195809411	<b>3,25</b>
	<b>61004</b>	125 Ø	64	8435195809428	<b>3,45</b>
	<b>61005</b>	130 Ø	64	8435195809435	<b>3,45</b>

### DIFUSOR 3 DISCOS HIERRO BLANCO



	Código	Medida	Caja	Código Barras	€ / Ud.
	<b>61101</b>	100 Ø	48	8435195809442	<b>3,58</b>
	<b>61102</b>	110 Ø	48	8435195809459	<b>3,58</b>
	<b>61103</b>	120 Ø	48	8435195809466	<b>3,58</b>
	<b>61104</b>	125 Ø	48	8435195809473	<b>3,68</b>
	<b>61105</b>	130 Ø	48	8435195809480	<b>3,97</b>

### DIFUSOR 3 DISCOS ALUMINIO BLANCO



	Código	Medida	Caja	Código Barras	€ / Ud.
	<b>61120</b>	100 Ø	18	8435195825008	<b>9,97</b>
	<b>61121</b>	110 Ø	18	8435195825015	<b>9,97</b>
	<b>61122</b>	120 Ø	18	8435195825022	<b>9,97</b>
	<b>61123</b>	125 Ø	18	8435195825039	<b>9,97</b>
	<b>61124</b>	130 Ø	18	8435195825046	<b>9,97</b>



## SUMIDEROS, CALDERETAS Y BOTE SIFÓNICO

**Sumideros**



**246**

**Calderetas**



**246**

**Bote sifónico**



**246**

## SUMIDEROS, CALDERETAS Y BOTE SIFÓNICO



### SUMIDERO DE LATÓN CROMADO



Código	Medida	Caja	Código Barras	€ / Ud.
<b>25522</b>	10 x 10	2	8435195817812	<b>19,72</b>

### SUMIDERO SIFÓNICO PVC

	Código	Medida	Caja	Código Barras	€ / Ud.
<b>10 x 10</b>	<b>25534</b>	Salida 50 Vertical/Horizontal	2	8435195824353	<b>5,62</b>

	Código	Medida	Caja	Código Barras	€ / Ud.
<b>15 x 15</b>	<b>25535</b>	Salida 75 - 50	2	8435195817829	<b>8,96</b>

	Código	Medida	Caja	Código Barras	€ / Ud.
<b>20 x 20</b>	<b>25536</b>	Salida 110 - 90	2	8435195817836	<b>8,96</b>

	Código	Medida	Caja	Código Barras	€ / Ud.
<b>25 x 25</b>	<b>25537</b>	Salida 110 - 90	2	8435195817843	<b>9,89</b>

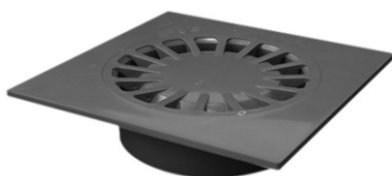

### CALDERETA SIFÓNICA PVC

	Código	Medida	Caja	Código Barras	€ / Ud.
<b>10 x 10</b>	<b>25542</b>	Salida 50 Vertical/Horizontal	2	8435195824360	<b>6,50</b>

	Código	Medida	Caja	Código Barras	€ / Ud.
<b>15 X 15</b>	<b>25538</b>	Salida 75 - 50	2	8435195817850	<b>8,92</b>

	Código	Medida	Caja	Código Barras	€ / Ud.
<b>20 x 20</b>	<b>25539</b>	Salida 110 - 90	2	8435195817867	<b>15,26</b>

	Código	Medida	Caja	Código Barras	€ / Ud.
<b>25 x 25</b>	<b>25540</b>	Salida 110 - 90	2	8435195817874	<b>15,26</b>



### BOTE SIFÓNICO PVC









Código	Descripción	Caja	Código Barras	€ / Ud.
<b>25541</b>	110 mm.	2	8435195817881	<b>6,62</b>





## ACCESORIOS DE COBRE

<b>Racor recto</b>		<b>248</b>
<b>Racor curvo</b>		<b>250</b>
<b>Manguitos</b>		<b>251</b>
<b>Codos</b>		<b>253</b>
<b>Tapón Hembra</b>		<b>254</b>
<b>Curva de 90°</b>		<b>254</b>
<b>Curva de 45°</b>		<b>255</b>
<b>Curvas desviación</b>		<b>255</b>
<b>Te H-H-H</b>		<b>256</b>

## ACCESORIOS DE COBRE



### RACOR CON ALOJAMIENTO DE JUNTAS sin precinto

RECTO 359GCU



Código	Medida	Caja	Código Barras	€ / Ud.
49201	10 x 3/8"	25	8435195828436	1,06
49202	12 x 3/8"	25	8435195828443	1,32
49206	12 x 1/2"	25	8435195828450	0,99
49207	14 x 1/2"	25	8435195828467	1,11
49212	14 x 3/4"	25	8435195838701	1,80
49204	15 x 3/8"	25	8435195828474	1,15
49208	15 x 1/2"	25	8435195828481	0,99
49213	15 x 3/4"	25	8435195828498	1,71
49209	16 x 1/2"	25	8435195828504	1,26
49214	16 x 3/4"	25	8435195828511	1,96
49210	18 x 1/2"	25	8435195828528	1,38
49215	18 x 3/4"	25	8435195828535	1,59
49211	22 x 1/2"	25	8435195828542	2,59
49216	22 x 3/4"	25	8435195828559	1,81
49217	22 x 1"	10	8435195828566	2,70
49219	28 x 3/4"	25	8435195838718	3,92
49218	28 x 1"	10	8435195828580	3,33
49221	28 x 1 1/4"	10	8435195828597	5,25
49222	35 x 1 1/4"	10	8435195828603	5,68
49224	42 x 1 1/2"	10	8435195828610	7,71
49226	54 x 2"	5	8435195828627	14,43

### RACOR CON JUNTA PLANA sin precinto

RECTO 359GCU



Código	Medida	Caja	Código Barras	€ / Ud.
49234	12 x 1/2"	25	8435195838770	1,05
49236	15 x 1/2"	25	8435195828634	1,03
49241	15 x 3/4"	25	8435195828641	1,71
49242	16 x 3/4"	25	8435195838817	1,96
49238	18 x 1/2"	25	8435195828658	1,38
49243	18 x 3/4"	25	8435195828665	1,59
49244	22 x 1/2"	25	8435195828672	2,67
49239	22 x 3/4"	25	8435195828689	2,55
49246	22 x 1"	25	8435195828696	2,81
49245	28 x 3/4"	25	8435195828702	3,67
49247	28 x 1"	25	8435195828719	3,23
49248	28 x 1 1/4"	25	8435195828726	5,25
49249	35 x 1 1/4"	25	8435195828733	5,68
49250	42 x 1 1/2"	25	8435195828740	7,71
49252	54 x 2"	25	8435195828757	14,43

## ACCESORIOS DE COBRE



### RACOR CON ALOJAMIENTO DE JUNTAS con precinto

RECTO 359GCU Con precinto



Código	Medida	Caja	Código Barras	€ / Ud.
49262	12 x 1/2"	25	8435195828764	1,27
49263	14 x 1/2"	25	8435195828771	1,30
49264	15 x 1/2"	25	8435195828788	1,22
49270	15 x 3/4"	25	8435195828825	1,94
49265	16 x 1/2"	25	8435195828795	1,33
49267	18 x 1/2"	25	8435195828801	1,57
49271	18 x 3/4"	25	8435195828832	1,76
49286	18 x 1"	25	8435195838916	3,18
49268	22 x 1/2"	25	8435195828818	2,79
49272	22 x 3/4"	25	8435195828849	1,94
49281	22 x 7/8"	25	8435195838862	2,77
49273	28 x 3/4"	25	8435195828856	3,85
49276	28 x 1"	10	8435195828863	3,32
49277	28 x 1 1/4"	10	8435195828870	5,25
49278	35 x 1 1/4"	10	8435195828887	5,94
49280	42 x 1 1/2"	10	8435195828894	8,34
49283	42 x 2"	10	8435195838886	14,96
49282	64 x 2 1/2"	10	8435195838879	36,38
49284	15 x 20/150	25	8435195838893	2,00
49285	18 x 20/150	25	8435195838909	2,02

### RACOR CON JUNTA PLANA con precinto

RECTO 359GCU Con precinto



Código	Medida	Caja	Código Barras	€ / Ud.
49301	12 x 3/8"	25	8435195828900	1,59
49302	12 x 1/2"	25	8435195828917	1,58
49304	15 x 1/2"	25	8435195828924	1,25
49309	15 x 3/4"	25	8435195828931	1,96
49305	16 x 1/2"	25	8435195828948	1,85
49306	18 x 1/2"	25	8435195828955	1,50
49312	18 x 3/4"	25	8435195828962	1,70
49307	22 x 1/2"	25	8435195828979	2,89
49314	22 x 3/4"	25	8435195828986	1,89
49315	28 x 3/4"	25	8435195828993	7,96
49316	28 x 1"	10	8435195829006	3,49
49317	28 x 1 1/4"	10	8435195829013	5,84
49318	35 x 1 1/4"	10	8435195829020	6,54
49319	42 x 1 1/2"	10	8435195829037	9,38

## ACCESORIOS DE COBRE



### RACOR CURVO CON ALOJAMIENTO DE JUNTAS sin precinto

#### CURVO 2AGCU



Código	Medida	Caja	Código Barras	€ / Ud.
49326	12 x 3/8"	25	8435195829044	1,74
49329	12 x 1/2"	25	8435195833768	1,62
49330	14 x 1/2"	25	8435195829068	1,68
49331	15 x 1/2"	25	8435195829075	1,62
49334	15 x 3/4"	25	8435195829358	2,60
49332	16 x 1/2"	25	8435195829082	1,76
49333	18 x 1/2"	25	8435195829099	1,88
49336	18 x 3/4"	25	8435195829105	2,62
49337	22 x 3/4"	25	8435195829112	2,78
49338	22 x 1"	10	8435195829129	4,23

### RACOR CURVO CON JUNTA PLANA sin precinto

#### CURVO 2AGCU



Código	Medida	Caja	Código Barras	€ / Ud.
49367	12 x 1/2"	25	8435195829198	1,66
49368	15 x 1/2"	25	8435195829204	1,62
49371	15 x 3/4"	25	8435195829228	2,60
49372	16 x 3/4"	25	8435195829235	2,70
49370	18 x 1/2"	25	8435195829211	1,89
49373	18 x 3/4"	25	8435195829242	2,62
49374	22 x 3/4"	25	8435195829599	2,75
49375	22 x 1"	10	8435195833775	4,28
49376	28 x 1"	10	8435195833782	4,88

### RACOR CURVO CON ALOJAMIENTO DE JUNTAS con precinto

#### CURVO 2AGCU con precinto



Código	Medida	Caja	Código Barras	€ / Ud.
49350	12 x 1/2"	25	8435195829136	1,89
49352	15 x 1/2"	25	8435195829143	1,86
49355	15 x 3/4"	25	8435195829167	2,86
49354	18 x 1/2"	25	8435195829150	2,14
49356	18 x 3/4"	25	8435195829174	2,86
49357	22 x 3/4"	25	8435195829181	2,99

### RACOR CURVO CON JUNTA PLANA con precinto

#### CURVO 2AGCU con precinto



Código	Medida	Caja	Código Barras	€ / Ud.
49381	12 x 1/2"	25	8435195829266	2,25
49382	15 x 1/2"	25	8435195829273	2,25
49384	15 x 3/4"	25	8435195829297	3,33
49385	16 x 3/4"	25	8435195829303	3,39
49383	18 x 1/2"	25	8435195829280	2,59
49386	18 x 3/4"	25	8435195829310	3,25
49387	22 x 3/4"	25	8435195829327	3,38
49388	22 x 1"	25	8435195829334	4,96
49389	28 x 1"	25	8435195829341	5,54

## MANGUITO REDUCCION H-H

FIGURA 5240



Código	Medida	Caja	Código Barras	€ / Ud.
<b>49405</b>	12 X 10	10	8435195829365	<b>0,96</b>
<b>49406</b>	14 X 12	10	8435195829372	<b>0,59</b>
<b>49407</b>	15 X 10	10	8435195829389	<b>1,18</b>
<b>49408</b>	15 X 12	10	8435195829396	<b>0,56</b>
<b>49409</b>	15 X 14	10	8435195829402	<b>0,65</b>
<b>49410</b>	16 X 12	10	8435195829419	<b>0,72</b>
<b>49411</b>	16 X 14	10	8435195829426	<b>0,72</b>
<b>49412</b>	16 X 15	10	8435195829433	<b>0,93</b>
<b>49413</b>	18 X 12	10	8435195829440	<b>1,19</b>
<b>49414</b>	18 X 14	10	8435195829457	<b>0,89</b>
<b>49415</b>	18 X 15	10	8435195829464	<b>0,62</b>
<b>49416</b>	18 X 16	10	8435195829471	<b>0,86</b>
<b>49417</b>	22 X 12	10	8435195829488	<b>2,85</b>
<b>49418</b>	22 X 14	10	8435195829495	<b>1,41</b>
<b>49419</b>	22 X 15	10	8435195829501	<b>1,26</b>
<b>49420</b>	22 X 16	10	8435195829518	<b>1,27</b>
<b>49421</b>	22 X 18	10	8435195829525	<b>1,16</b>
<b>49422</b>	28 X 12	10	8435195829532	<b>4,56</b>
<b>49423</b>	28 X 15	10	8435195829549	<b>2,89</b>
<b>49424</b>	28 X 18	10	8435195829556	<b>2,57</b>
<b>49425</b>	28 X 22	10	8435195829563	<b>1,59</b>
<b>49427</b>	35 X 18	10	8435195829570	<b>7,63</b>
<b>49428</b>	35 X 22	10	8435195829587	<b>4,83</b>
<b>49429</b>	35 X 28	10	8435195859594	<b>5,25</b>
<b>49432</b>	42 X 28	5	8435195829600	<b>8,75</b>
<b>49435</b>	42 X 35	5	8435195829617	<b>6,50</b>
<b>49440</b>	54 x 28	5	8435195839067	<b>18,35</b>
<b>49436</b>	54 x 35	5	8435195839043	<b>14,70</b>
<b>49433</b>	54 X 42	5	8435195829624	<b>11,96</b>
<b>49437</b>	64 x 35	1	8435195839050	<b>20,90</b>
<b>49434</b>	64 X 54	1	8435195829631	<b>23,29</b>
<b>49441</b>	67 X 54	1	8435195829648	<b>24,69</b>
<b>49442</b>	76 X 54	1	8435195829655	<b>39,27</b>
<b>49443</b>	76 X 64	1	8435195829662	<b>36,49</b>

## MANGUITO REDUCCION M-H

FIGURA 5243

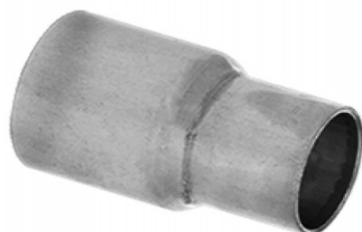

Código	Medida	Caja	Código Barras	€ / Ud.
49448	12 x 10	10	8435195829679	<b>0,80</b>
49449	14 x 12	10	8435195829686	<b>0,46</b>
49450	15 x 10	10	8435195829693	<b>0,93</b>
49451	15 x 12	10	8435195829709	<b>0,50</b>
49452	15 x 14	10	8435195829716	<b>0,66</b>
49453	16 x 12	10	8435195829723	<b>0,58</b>
49454	16 x 14	10	8435195829730	<b>0,52</b>
49455	18 x 12	10	8435195829747	<b>0,89</b>
49456	18 x 14	10	8435195829754	<b>0,76</b>
49457	18 x 15	10	8435195829761	<b>0,48</b>
49458	18 x 16	10	8435195829778	<b>0,68</b>
49459	22 x 12	10	8435195829785	<b>2,19</b>
49460	22 x 14	10	8435195829792	<b>0,96</b>
49461	22 x 15	10	8435195829808	<b>0,83</b>
49462	22 x 16	10	8435195829815	<b>0,85</b>
49463	22 x 18	10	8435195829822	<b>0,86</b>
49464	28 x 12	10	8435195829839	<b>3,28</b>
49465	28 x 14	10	8435195829846	<b>2,76</b>
49466	28 x 15	10	8435195829853	<b>1,99</b>
49467	28 x 16	10	8435195829860	<b>2,63</b>
49468	28 x 18	10	8435195829877	<b>2,15</b>
49469	28 x 22	10	8435195829884	<b>1,39</b>
49470	35 x 15	10	8435195829891	<b>8,25</b>
49471	35 x 18	10	8435195829907	<b>4,83</b>
49472	35 x 22	10	8435195829914	<b>4,72</b>
49473	35 x 28	10	8435195829921	<b>3,26</b>
49474	42 x 18	5	8435195829938	<b>18,47</b>
49475	42 x 22	5	8435195829945	<b>8,48</b>
49476	42 x 28	5	8435195829952	<b>6,93</b>
49477	42 x 35	5	8435195829969	<b>6,25</b>
49478	54 x 28	5	8435195829976	<b>16,60</b>
49479	54 x 35	5	8435195829983	<b>13,61</b>
49480	54 x 42	5	8435195829990	<b>11,42</b>
49481	64 x 54	1	8435195830002	<b>19,98</b>
49482	67 x 54	1	8435195830019	<b>23,93</b>
49483	76 x 54	1	8435195830026	<b>37,48</b>
49484	76 x 64	1	8435195830033	<b>34,47</b>
49485	80 x 67	1	8435195830040	<b>34,47</b>

## ACCESORIOS DE COBRE



### MANGUITO CON TOPE H-H

FIGURA 5270



Código	Medida	Caja	Código Barras	€ / Ud.
49703	10	10	8435195830057	0,37
49704	12	10	8435195830064	0,29
49705	14	10	8435195830071	0,26
49706	15	10	8435195830088	0,26
49707	18	10	8435195830095	0,37
49708	22	10	8435195830101	0,62
49709	28	10	8435195830118	1,23
49710	35	10	8435195830125	2,58
49711	42	5	8435195830132	4,30
49712	54	5	8435195830149	7,39
49713	64	1	8435195830156	16,36
49714	66,7	1	8435195830163	20,53
49715	76,1	1	8435195830170	25,55
49716	80	1	8435195830187	33,62
49718	108	1	8435195830194	92,61

### CODO 90° H-H

FIGURA 5090



Código	Medida	Caja	Código Barras	€ / Ud.
49600	10	10	8435195830200	0,74
49601	12	10	8435195830217	0,46
49602	14	10	8435195830224	0,48
49603	15	10	8435195830231	0,45
49604	16	10	8435195830248	0,56
49605	18	10	8435195830255	0,64
49606	22	10	8435195830262	1,04
49607	28	10	8435195830279	1,86
49608	35	5	8435195830286	6,50
49609	42	5	8435195830293	9,98
49610	54	1	8435195830309	19,53
49611	64	1	8435195830316	36,39
49612	66,7	1	8435195830323	51,06
49613	76,1	1	8435195830330	94,23
49614	80	1	8435195830347	99,88
49615	108	1	8435195830354	199,91

### CODO 90° M-H

FIGURA 5092



Código	Medida	Caja	Código Barras	€ / Ud.
49616	10	10	8435195830361	1,79
49617	12	10	8435195830378	0,84
49618	14	10	8435195830385	0,57
49619	15	10	8435195830392	0,47
49620	16	10	8435195830408	0,71
49621	18	10	8435195830415	1,05
49622	22	10	8435195830422	1,69
49623	28	10	8435195830439	2,64
49624	35	5	8435195830446	9,95
49625	42	5	8435195830453	14,09
49626	54	1	8435195830460	24,39
49627	64	1	8435195830477	48,36
49628	67	1	8435195830484	61,56

## ACCESORIOS DE COBRE



### TAPÓN H

FIGURA 5301



Código	Medida	Caja	Código Barras	€ / Ud.
<b>49516</b>	10	10	8435195831092	<b>1,49</b>
<b>49517</b>	12	10	8435195831108	<b>0,85</b>
<b>49518</b>	14	10	8435195831115	<b>0,96</b>
<b>49519</b>	15	10	8435195831122	<b>0,60</b>
<b>49520</b>	16	10	8435195831139	<b>1,27</b>
<b>49521</b>	18	10	8435195831146	<b>0,79</b>
<b>49522</b>	22	10	8435195831153	<b>1,28</b>
<b>49523</b>	28	10	8435195831160	<b>2,28</b>
<b>49524</b>	35	5	8435195831177	<b>6,33</b>
<b>49525</b>	42	5	8435195831184	<b>8,25</b>
<b>49526</b>	54	5	8435195831191	<b>12,97</b>

### CURVA 90° H-H

FIGURA 5002A



Código	Medida	Caja	Código Barras	€ / Ud.
<b>49660</b>	10	10	8435195830606	<b>0,93</b>
<b>49661</b>	12	10	8435195830613	<b>0,46</b>
<b>49662</b>	14	10	8435195830620	<b>0,57</b>
<b>49663</b>	15	10	8435195830637	<b>0,63</b>
<b>49664</b>	16	10	8435195830644	<b>0,68</b>
<b>49665</b>	18	10	8435195830651	<b>0,82</b>
<b>49666</b>	22	10	8435195830668	<b>1,29</b>
<b>49667</b>	28	10	8435195830675	<b>2,25</b>
<b>49668</b>	35	5	8435195830682	<b>5,79</b>
<b>49669</b>	42	5	8435195830699	<b>8,67</b>
<b>49670</b>	54	1	8435195830705	<b>15,67</b>
<b>49671</b>	64	1	8435195833799	<b>46,42</b>
<b>49672</b>	66,7	1	8435195833805	<b>60,64</b>
<b>49673</b>	76,1	1	8435195833812	<b>83,56</b>
<b>49674</b>	80	1	8435195833829	<b>104,27</b>

### CURVA 90° M-H

FIGURA 5001A



Código	Medida	Caja	Código Barras	€ / Ud.
<b>49643</b>	10	10	8435195830491	<b>1,01</b>
<b>49644</b>	12	10	8435195830507	<b>0,85</b>
<b>49645</b>	14	10	8435195830514	<b>0,65</b>
<b>49646</b>	15	10	8435195830521	<b>0,59</b>
<b>49647</b>	16	10	8435195830538	<b>0,74</b>
<b>49648</b>	18	10	8435195830545	<b>0,90</b>
<b>49649</b>	22	10	8435195830552	<b>1,32</b>
<b>49650</b>	28	5	8435195830569	<b>3,16</b>
<b>49651</b>	35	5	8435195830576	<b>8,56</b>
<b>49652</b>	42	1	8435195830583	<b>11,72</b>
<b>49653</b>	54	1	8435195830590	<b>17,94</b>



## CURVA 45° H-H

FIGURA 5041



Código	Medida	Caja	Código Barras	€ / Ud.
49501	10	10	8435195830941	1,30
49502	12	10	8435195830958	0,92
49503	14	10	8435195830965	0,67
49504	15	10	8435195830972	0,51
49505	16	10	8435195830989	0,91
49506	18	10	8435195830996	1,27
49507	22	10	8435195831009	1,44
49508	28	10	8435195831016	2,64
49509	35	5	8435195831023	7,39
49510	42	5	8435195831030	9,97
49511	54	1	8435195831047	17,51
49512	64	1	8435195831054	50,90
49513	66,7	1	8435195831061	51,73
49514	76,1	1	8435195831078	97,47
49515	80	1	8435195831085	78,56

## CURVA 45° M-H

FIGURA 5040



Código	Medida	Caja	Código Barras	€ / Ud.
49631	10	10	8435195830828	1,43
49632	12	10	8435195830835	0,77
49633	14	10	8435195830842	0,66
49634	15	10	8435195830859	0,53
49635	18	10	8435195830860	1,25
49636	22	10	8435195830873	1,19
49637	28	10	8435195830880	2,24
49638	35	5	8435195830897	7,82
49639	42	5	8435195830903	10,24
49640	54	1	8435195830910	16,96
49641	64	1	8435195830927	48,60
49642	67	1	8435195830934	53,98

## CURVA DESVIACIÓN H-H

FIGURA 5085



Código	Medida	Caja	Código Barras	€ / Ud.
49688	12	10	8435195830712	4,20
49689	14	10	8435195830729	4,30
49690	15	10	8435195830736	2,98
49691	18	10	8435195830743	7,43
49692	22	10	8435195830750	8,56

## CURVA DESVIACIÓN M-H

FIGURA 5086



Código	Medida	Caja	Código Barras	€ / Ud.
49680	12	10	8435195830767	3,72
49681	14	10	8435195830774	4,06
49682	15	10	8435195830781	2,18
49683	16	10	8435195830798	4,78
49684	18	10	8435195830804	5,02
49685	22	10	8435195830811	7,08

## ACCESORIOS DE COBRE



### TE RECTA H-H-H

FIGURA 5130

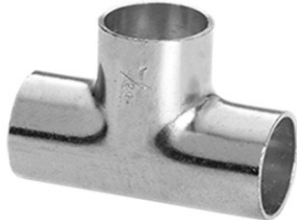

Código	Medida	Caja	Código Barras	€/ Ud.
49531	10	10	8435195831207	1,58
49532	12	10	8435195831214	0,76
49533	14	10	8435195831221	0,67
49534	15	10	8435195831238	0,65
49535	16	10	8435195831245	0,81
49536	18	10	8435195831252	1,29
49537	22	10	8435195831269	2,11
49538	28	10	8435195831276	3,99
49539	35	5	8435195831283	9,43
49540	42	5	8435195831290	17,71
49541	54	5	8435195831306	26,37
49542	64	1	8435195831313	68,48
49543	66,7	1	8435195831320	72,52
49544	76,1	1	8435195831337	88,48
49545	80	1	8435195831344	122,98
49546	108	1	8435195831351	213,50

### TE REDUCIDA H-H-H

FIGURA 5130R



Código	Medida	Caja	Código Barras	€/ Ud.
49549	12 x 10 x 10	10	8435195831368	2,70
49550	12 x 14 x 12	10	8435195831375	1,41
49551	12 x 15 x 12	10	8435195831382	2,29
49552	14 x 12 x 12	10	8435195831399	1,10
49553	14 x 12 x 14	10	8435195831405	1,02
49554	14 x 14 x 12	10	8435195831412	1,06
49555	14 x 18 x 14	10	8435195839074	5,38
49557	15 x 12 x 12	10	8435195831429	2,41
49558	15 x 12 x 15	10	8435195831436	1,33
49559	15 x 15 x 12	10	8435195831443	3,04
49560	15 x 18 x 15	10	8435195831450	3,33
49561	15 x 22 x 15	10	8435195831467	6,32
49562	16 x 12 x 12	10	8435195831474	2,07
49563	16 x 12 x 14	10	8435195831481	1,59
49564	16 x 12 x 16	10	8435195831498	1,50
49565	16 x 14 x 12	10	8435195831504	2,24
49566	16 x 14 x 14	10	8435195831511	1,51
49567	16 x 14 x 16	10	8435195831528	1,29
49568	16 x 22 x 16	10	8435195839081	4,89
49569	18 x 12 x 12	10	8435195831535	5,34
49570	18 x 12 x 15	10	8435195831542	5,59
49571	18 x 12 x 16	10	8435195831559	3,21
49572	18 x 12 x 18	10	8435195831566	2,15
49573	18 x 14 x 14	10	8435195831573	2,72
49574	18 x 14 x 18	10	8435195831580	1,51
49575	18 x 15 x 12	10	8435195831597	6,08
49576	18 x 15 x 15	10	8435195831603	1,85
49577	18 x 15 x 18	10	8435195831610	1,24
49578	18 x 16 x 16	10	8435195831627	2,86
49579	18 x 16 x 18	10	8435195831634	2,64
49580	18 x 18 x 12	10	8435195831641	6,50
49581	18 x 18 x 14	10	8435195831658	2,80
49582	18 x 18 x 15	10	8435195831665	2,02

## ACCESORIOS DE COBRE



### TE REDUCIDA H-H-H

FIGURA 5130R



Código	Medida	Caja	Código Barras	€ / Ud.
49583	18 x 22 x 18	10	8435195831672	4,43
49584	18 x 28 x 18	10	8435195831689	2,45
49585	22 x 12 x 12	10	8435195831696	6,47
49586	22 x 12 x 22	10	8435195831702	5,60
49587	22 x 14 x 14	10	8435195831719	5,50
49588	22 x 14 x 22	10	8435195831726	2,55
49590	22 x 15 x 15	10	8435195831733	2,98
49591	22 x 15 x 18	10	8435195831740	3,30
49593	22 x 15 x 22	10	8435195831757	1,46
49594	22 x 16 x 16	10	8435195831764	4,38
49596	22 x 16 x 22	10	8435195831771	2,66
49597	22 x 18 x 15	10	8435195831788	5,96
49598	22 x 18 x 18	10	8435195831795	3,45
49599	22 x 18 x 22	10	8435195831801	2,42
49806	22 x 22 x 12	10	8435195831818	7,49
49807	22 x 22 x 15	10	8435195831825	4,36
49808	22 x 22 x 18	10	8435195831832	5,09
49809	22 x 28 x 22	10	8435195831849	8,21
49810	28 x 12 x 28	10	8435195831856	10,73
49811	28 x 15 x 15	10	8435195831863	10,21
49812	28 x 15 x 22	10	8435195831870	8,07
49813	28 x 15 x 28	10	8435195831887	3,33
49814	28 x 16 x 28	10	8435195831894	6,50
49815	28 x 18 x 15	10	8435195831900	11,13
49816	28 x 18 x 18	10	8435195831917	11,03
49817	28 x 18 x 22	10	8435195831924	8,04
49818	28 x 18 x 28	10	8435195831931	5,24
49819	28 x 22 x 15	10	8435195831948	11,75
49820	28 x 22 x 18	10	8435195831955	10,72
49821	28 x 22 x 22	10	8435195831962	6,57
49822	28 x 22 x 28	10	8435195831979	3,70
49823	28 x 28 x 15	10	8435195831986	11,57
49824	28 x 28 x 18	10	8435195831993	10,50
49825	28 x 28 x 22	10	8435195832006	8,88
49826	28 x 35 x 28	1	8435195832013	15,55
49831	35 x 15 x 35	1	8435195832020	13,73
49832	35 x 18 x 35	1	8435195832037	14,16
49589	35 x 22 x 35	1	8435195832044	9,60
49834	35 x 22 x 28	1	8435195832051	13,15
49835	35 x 28 x 22	1	8435195832068	19,23
49836	35 x 28 x 28	1	8435195832075	13,60
49837	35 x 28 x 35	1	8435195832082	13,32
49838	35 x 35 x 22	1	8435195832099	23,31
49839	35 x 35 x 28	1	8435195832105	22,11
49592	42 x 22 x 42	1	8435195832112	17,19
49840	42 x 28 x 42	1	8435195832129	18,85
49841	42 x 35 x 35	1	8435195832136	26,65
49842	42 x 35 x 42	1	8435195832143	21,78
49843	42 x 42 x 28	1	8435195832150	28,48
49595	54 x 22 x 54	1	8435195832167	35,58
49852	54 x 28 x 54	1	8435195832174	58,48
49853	54 x 35 x 54	1	8435195832181	33,94
49854	54 x 42 x 54	1	8435195832198	35,12
49851	64 x 42 x 64	1	8435195832204	63,93

# CONDICIONES GENERALES DE VENTA



## CATÁLOGO

---

Los precios indicados en este catálogo son los vigentes a fecha de su edición (Junio 2019) anulando tarifas, ofertas y precios especiales anteriores.

Mediterránea de Válvulas se reserva el derecho de modificación en cualquier momento y sin previo aviso en caso de variación en sus condiciones de aprovisionamiento o fabricación.

En caso de estar interesado en que le notifiquemos cualquier modificación que se produzca en el mismo, deberá enviarnos un correo electrónico a nuestra dirección [info@meval.es](mailto:info@meval.es), indicando en el apartado "Asunto" la palabra "Altalista" y en el cuerpo la denominación del cliente que nos lo envía. De esta forma, entrará en una lista de correo interna, por la cual se le notificará cualquier variación que se produzca en nuestros productos, y muy especialmente, en nuestros precios.

Las imágenes mostradas en la tarifa son orientativas para facilitar la identificación de cada artículo, lo que no significa que la pieza a suministrar sea exactamente igual a la mostrada en la misma.

## IMPUESTOS

---

En los precios de esta tarifa no va incluido el I.V.A. Cualquier otro tipo de impuesto será siempre a cargo del comprador.

## PORTES

---

Para pedidos superiores a 300 euros netos a cualquier destino de península y Baleares, se enviarán a portes pagados.

Para pedidos inferiores a 300 euros netos, se cargarán 9 euros en factura en concepto de portes o se enviará a portes debidos siempre que el comprador así lo indique.

Para pedidos con destinos Ceuta, Melilla y Canarias se enviarán a portes pagados cuando sean superiores a 1.200 euros.

La empresa no se hace cargo de las reexpediciones de recaderos o agencias locales, cuyos gastos irán a cargo del destinatario. No obstante, en el caso de que el pedido sea superior a 400 euros netos, la reexpedición sí irá a cargo de Meval.

Los pedidos con carácter urgente o que necesiten de otra agencia de transporte distinta a la que Meval tiene contratada, irán a cargo del comprador.

## EMBALAJE

---

Todos los pedidos se enviarán libres de gastos de embalaje, siempre que el pedido se ajuste a los embalajes indicados en tarifa.

## CONDICIONES DE VENTA

---

A convenir entre ambas partes.

## CONDICIONES GENERALES DE VENTA



### FORMA DE PAGO

---

El pago será efectuado en las condiciones pactadas con el comprador y en los plazos estipulados con el mismo.

### GARANTÍA

---

Queda limitada exclusivamente al reemplazamiento del material reconocido como defectuoso por el personal técnico de Meval, sin indemnización.

En el caso de producirse un siniestro, **MEDITERRÁNEA DE VÁLVULAS** se hará responsable única y exclusivamente cuando el defecto sea de fabricación de nuestros productos. De ser así, es condición obligatoria que el damnificado dé parte a nuestra empresa en el momento del siniestro, para proceder a la activación del procedimiento de peritación. En caso contrario la empresa no se hará cargo de los daños ocasionados.

### DEVOLUCIONES Y RECLAMACIONES

---

Únicamente se admitirán devoluciones y reclamaciones dentro de los 30 días de la fecha de recepción de la mercancía. En caso de devolución, siempre y cuando el material sea devuelto en las mismas condiciones que se envió.

Las devoluciones a portes debidos, solo se admitirán a través de la agencia que MEDITERRÁNEA DE VÁLVULAS determine.

### COMPETENCIA JURÍDICA

---

Ambas partes se someten para cualquier litigio a los Juzgados y Tribunales de Valencia.

### CLÁUSULA DE PROTECCIÓN DE DATOS

---

Según lo Dispuesto por el Reglamento (UE) 2016/679 del Parlamento Europeo y del Consejo de 27 de abril de 2016 relativo a la protección de las personas físicas en lo que respecta al tratamiento de datos personales y a la libre circulación de estos datos, le informamos que tratamos la información que nos facilita con el fin de prestarles el servicio solicitado, realizar la facturación del mismo, y llevar las gestiones fiscales exigidas por Ley. Los datos proporcionados se conservaran mientras se mantenga la relación comercial o durante los años necesarios para cumplir con las obligaciones legales. Los datos no se cederán a terceros salvo en los casos en que exista una obligación legal. Usted tiene derecho a obtener confirmación sobre si en **MEDITERRÁNEA DE VÁLVULAS, S.L.** estamos tratando sus datos personales por tanto tiene derecho a ejercer los derechos de acceso, rectificación, limitación de tratamiento, supresión, portabilidad y oposición/revocación, en los términos que establece la normativa vigente en materia de protección de datos dirigiendo su petición a [info@meval.es](mailto:info@meval.es), asimismo, podrá dirigirse a la Autoridad de Control competente para presentar la reclamación que considere oportuna. Asimismo nos autoriza para ofrecerle productos y servicios relacionados con los solicitados y fidelizarle como cliente.







**MEDITERRÁNEA DE VÁLVULAS, S.L.**

Pol. Ind. Torrubero - Av. Constitución. 5 - 46136 MUSEROS (Valencia) España

Tel. 96 185 82 03 - Fax 96 185 83 90

[info@meval.es](mailto:info@meval.es) - [www.meval.es](http://www.meval.es)